



Welcome

Manual Description

- This User Manual corresponds to vehicle system version V5.8.5. On the CID(Central Information Display), tap “→**Settings**→**General**” to view the current system version. If the system version is not up to date, update it promptly.
- Descriptions marked with “*” in this manual apply only to certain configurations. Your vehicle may not be equipped with these features.
- The vehicle supports Over-the-Air (OTA) updates. Vehicle functions are periodically optimized and updated, and the contents of this manual will be updated from time to time.
- This manual provides information on all configurations of this model. Due to differences in vehicle configuration, software versions, and other factors, your actual vehicle may differ from the descriptions. In such cases, the actual vehicle shall prevail.
- Carefully read the warnings and cautions in this manual:
 - ▲ **WARNING** information. Strictly follow these instructions; failure to do so may result in serious injury, death, or a traffic accident.
 - ▲ **CAUTION** information. Strictly follow these instructions; failure to do so may result in vehicle damage or malfunction.
 - i **NOTE** information. These tips help you use the vehicle more effectively.



- The illustrations in this manual are for explaining functions and operations only and are for reference purposes.
- The illustrations in this manual include the following annotations:
 - ➡ Indicates the object being described.
 - ⇨ Indicates the direction of a sliding movement.
 - ↻ Indicates the direction of a rotating movement.
 - ↷ Indicates the direction of a flipping movement.
- Unless otherwise specified, all references to vehicle orientation (front, rear, left, right) in this manual are based on the direction of forward travel.

Without authorization from XPENG, no part of this manual may be reproduced or modified, in whole or in part. XPENG reserves the right to change, supplement, or discontinue the contents of this manual and its technical specifications at any time.

Important Notes

For your safety, when driving the vehicle, observe local laws and regulations and follow the important instructions below when using the vehicle:

- When driving the vehicle, the driver must comply with traffic regulations, control vehicle speed, and avoid driving at excessive speed or overloading the vehicle.



- All occupants must wear their seat belts at all times while the vehicle is in motion.
- Before driving the vehicle, always make sure that all four doors and both lids are fully closed, and verify that the vehicle is in good operating condition and all functions can be used safely and normally.
- Always remain fully alert while driving. Never drive after drinking alcohol or when fatigued, as this will impair your control of the vehicle and may lead to accidents resulting in serious injury or death.
- Always drive with caution. Assess whether the weather and road conditions are suitable for travel, and constantly pay attention to the movements of other vehicles and pedestrians so you can react in time and prevent accidents.
- Do not use handheld devices to make calls, check messages, or for similar activities while driving, as this will distract you and affect your control of the vehicle.



Exterior Overview

Front Side Overview

2

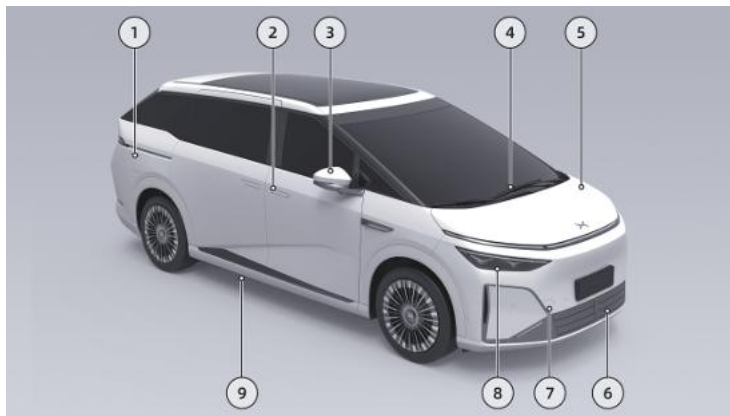

1. Charge port cover [See 379 page](#)
2. Exterior door handle [See 95 page](#)
3. Side mirror [See 223 page](#)
4. Front wipers [See 219 page](#)

5. Front hood
6. Active grille shutter
7. Tow hook cover
8. Front headlight [See 207 page](#)



9. Light-carpet welcome lights [See 215 page](#)



Rear Side Overview

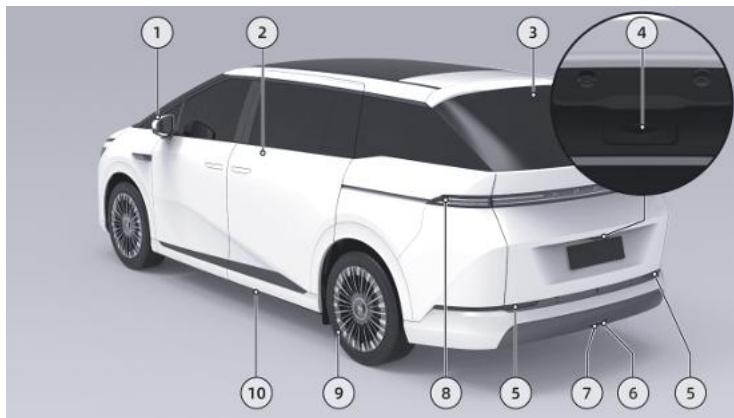

1. NFC card sensing area
2. Sliding door [See 102 page](#)
3. High-mounted brake light
4. Trunk exterior switch
5. Retroreflector
6. Rear fog light/Reverse light [See 209 page](#)
7. Rear fog light/Reverse light [See 209 page](#)
8. Taillight [See 207 page](#)
9. Wheel [See 468 page](#)
10. Light-carpet welcome lights [See 215 page](#)



Interior Overview

Front Row Roof Overview

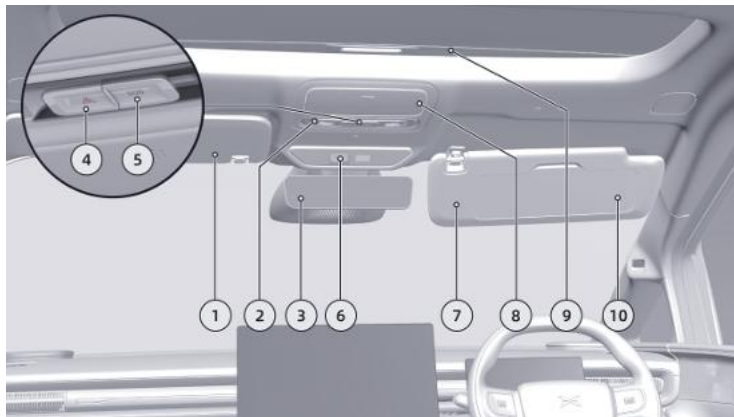

1. Sun visor [See 240 page](#)
2. Front reading lights [See 216 page](#)
3. Streaming interior rearview mirror [See 227 page](#)
4. Hazard warning light button [See 211 page](#)
5. SOS button [See 211 page](#)
6. OMS in-cabin camera [See 314 page](#)
7. Vanity mirror cover [See 241 page](#)

Vehicle Overview



- 8. Glasses holder [See 244 page](#)
- 9. Front manual sunshade [See 205 page](#)
- 10. Vanity mirror [See 241 page](#)



Driver Side Overview

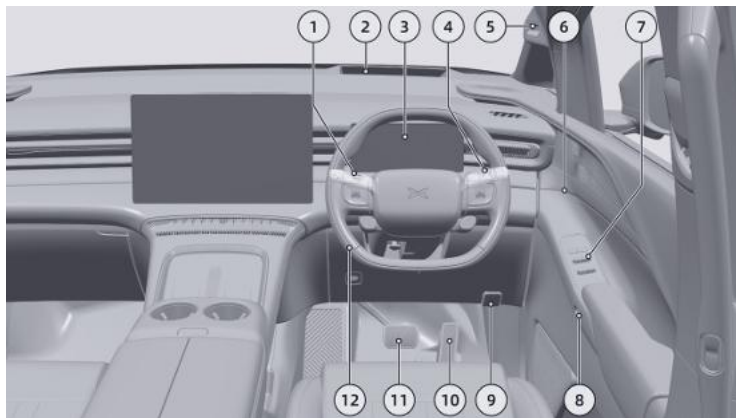

2

1. Lighting & wiper stalk [See 219 page](#)
2. Head-Up Display (HUD) [See 51 page](#)
3. Instrument panel [See 23 page](#)
4. Gear shift lever [See 251 page](#)
5. DSM camera [See 375 page](#)
6. Ambient lights [See 216 page](#)
7. Door switch panel
8. Interior door release button
9. Front hood release handle [See 460 page](#)
10. Accelerator pedal [See 256 page](#)

Vehicle Overview



11. Brake pedal [See 269 page](#)
12. Steering wheel [See 194 page](#)



Front Passenger Side Overview



2

1. Ambient lights [See 216 page](#)

2. Air conditioner vent [See 143 page](#)

3. Side defrost vent

4. Right front door switch panel

5. Interior door release button

6. Glove box [See 244 page](#)



Front Center Console Overview

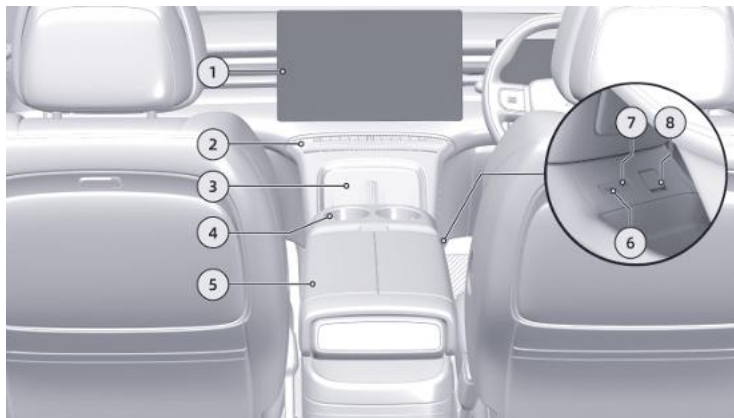

1. Touchscreen
2. Air conditioner vent [See 143 page](#)
3. Wireless charging [See 231 page](#)
4. Cup holder [See 242 page](#)
5. Center armrest box [See 244 page](#)
6. USB media source port [See 237 page](#)
7. Type-C power outlet [See 237 page](#)
8. 12V power outlet [See 237 page](#)



Rear Center Console Overview



2

1. Sliding door switch panel
 - Sliding door window switch [See 201 page](#)
 - Rear entertainment screen switch [See 44 page](#)
2. Sliding door switch [See 103 page](#)
3. Folding table [See 157 page](#)
4. Rear footwell vents
5. Rear air conditioner control panel
6. Second-row face-level vents [See 143 page](#)
7. Front seat magazine pockets [See 244 page](#)



8. Dual hot-and-cold power refrigerator [See 235 page](#)



Second Row Passenger Side Overview

2

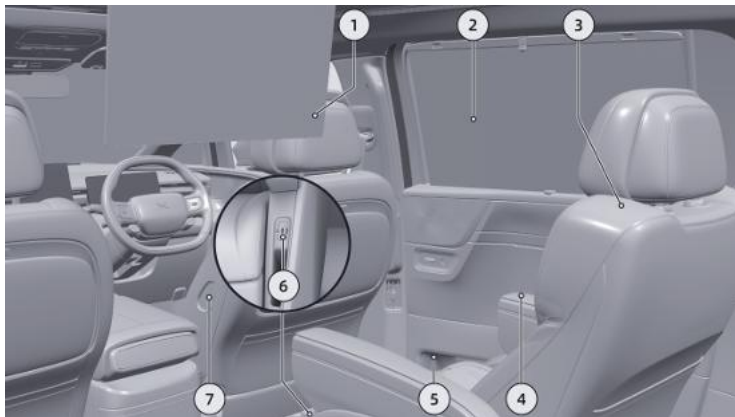

1. Entertainment display
2. Side window sunshade [See 207 page](#)
3. Second-row seats [See 166 page](#)
4. Second-row wireless charging [See 232 page](#)
5. Sliding door cup holder [See 242 page](#)
6. Second-row seat Type-C power outlet [See 238 page](#)
7. Master key [See 161 page](#)



Third Row Passenger Side Overview

2

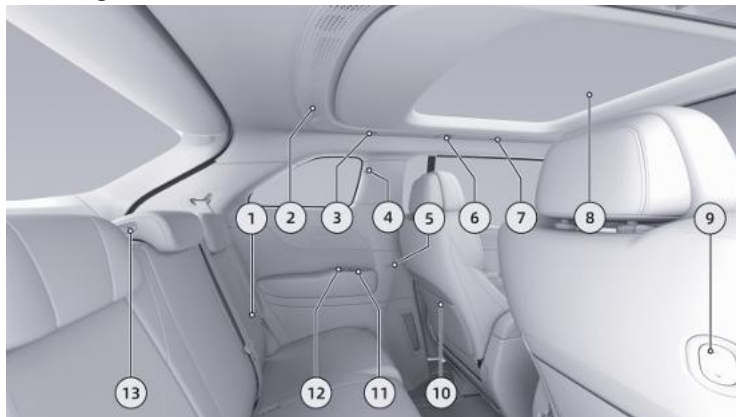

1. Third-row seats [See 18 page](#)
2. Surround air vents
3. Third-row reading light [See 216 page](#)
4. Hook [See 244 page](#)
5. Type-C power outlet [See 238 page](#)
6. Overhead reading light [See 216 page](#)
7. Second-row reading light [See 216 page](#)
8. Rear electric sunshade [See 205 page](#)
9. Third-row passenger easy entry/exit switch [See 175 page](#)



10. Second-row seat magazine pockets [See 244 page](#)
11. Cup holder [See 242 page](#)
12. Side switch panel [See 177 page](#)
13. Center headrest adjustment switch



Trunk Overview

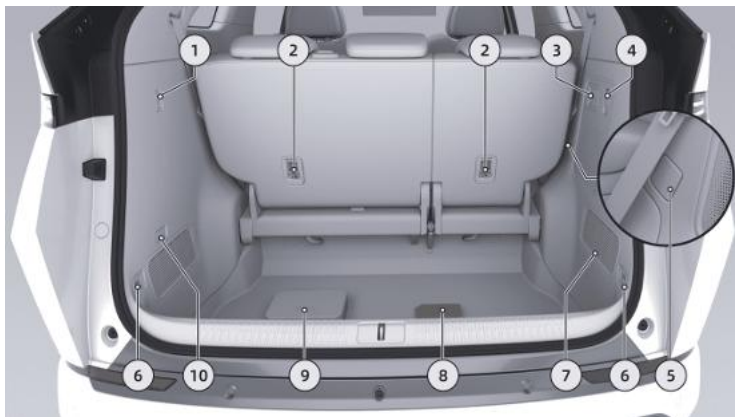

1. Trunk hook
2. Child seat anchor points
3. Trunk multi-function switch
 - Seatback fold/store switch
4. 12V power outlet
5. Emergency release cover for slow charging port
 - Easy loading



6. Trunk floor tie-downs
7. Trunk service cover
8. Reflective vest
9. Onboard tool kit
10. Trunk light



Front Compartment Overview



1. Coolant reservoir [See 465 page](#)

2. Brake fluid reservoir [See 462 page](#)

3. Low-voltage service switch

4. Front compartment fuse box

5. Windshield washer fluid reservoir [See 467 page](#)



Instrument Panel

Page Display



1. Indicator light

- Indicator lights are distributed at different locations on the instrument panel and

reflect the status of various vehicle functions.

- Vehicle speed
- Gear position



4. Time
5. Outside ambient temperature
6. Range:
 - On the touchscreen, in the “→Settings→Charging & Discharging→Charging” screen, you can switch the display between CLTC and WLTP.
7. Driving Mode
8. Power gauge



Instrument Panel Settings

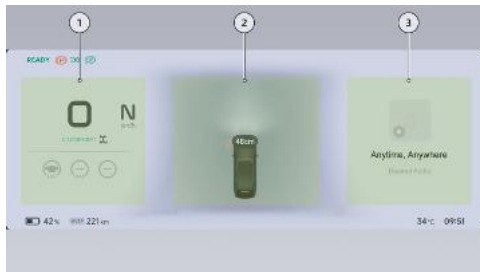

1. Left information display area
2. Center information display area
3. Right information display area

Setting the left information display area

1. Press and hold the right scroll wheel on the steering wheel to enter the instrument panel card selection mode.



2. In Perception mode, scroll the left scroll wheel on the steering wheel up or down to select the left information card. You can select vehicle speed, music, map, mileage, energy consumption, or tire pressure status cards. Press the left or right scroll wheel briefly to confirm the selection.



In Map mode, scroll the left scroll wheel on the steering wheel up or down to select the left information card. You can select vehicle speed, music, map, mileage, energy consumption, or tire pressure status cards. Press the left or right scroll wheel briefly to confirm the selection.



Setting the center information display area

1. Press and hold the right scroll wheel on the steering wheel to enter the instrument panel card selection mode.



2. Briefly press the left/right buttons on either side of the steering wheel to select Smart Drive mode or Map mode, then briefly press the left or right scroll wheel to confirm the selection.



- Smart Drive mode: The center information display area shows the vehicle status and a simulated external driving environment.
- Map mode: The center information display area shows navigation map information.

i Tips

When Map Mode is selected, if the gear is shifted to Reverse (R), the instrument panel will automatically switch to Smart Drive Mode. After shifting to another gear and turning off

the 360 Camera, it will automatically switch back to Map Mode.

Setting the right information display area

1. Press and hold the right scroll wheel on the steering wheel to enter the instrument panel card selection mode.



2. In Smart Drive mode, scroll the right scroll wheel on the steering wheel up or down to select the right information card. You can

select vehicle speed, music, map, mileage, energy consumption, or tire pressure status cards. Press the left or right scroll wheel briefly to confirm the selection.



In Map mode, scroll the right scroll wheel on the steering wheel up or down to select the right information card. You can select vehicle speed, music, map, mileage, energy consumption, or tire pressure status cards.



Press the left or right scroll wheel briefly to confirm the selection.



i Tips

The left and right information display areas cannot show the same information card at the same time.

Instrument Indicator Lights

After the vehicle is powered on, some indicator lights will illuminate. Once the system self-check is complete, the indicator lights will turn off if the system is operating normally. Some indicator lights illuminate to show the current status of vehicle system functions and do not indicate a system malfunction. If you have any questions during daily vehicle use, contact an XPENG service center.

3



indicator_high_beam_lights on



Airbag has a malfunction



indicator_smart_high_beam_blue on



Driver seat belt not fastened



indicator_smart_high_beam_yellow fault



Front passenger seat belt not fastened



indicator_smart_high_beam_grey on



Second-row left seat belt unfastened,
third-row left seat belt unfastened



indicator_left_turn_lamp on



Second-row left seat belt unfastened,
third-row left seat unoccupied or seat
belt fastened



indicator_left_turn_lamp on



Second-row left seat unoccupied or seat belt fastened, third-row left seat belt unfastened



indicator_elow_beam on



Second-row left seat unoccupied or seat belt fastened, third-row left seat unoccupied or seat belt fastened



indicator_fog_lights on



Third-row center seat belt unfastened



indicator_parking_lamp on



Third-row center seat unoccupied or seat belt fastened



indicator_auto_elow_beam_green on



Second-row right seat belt unfastened, third-row right seat belt unfastened



Road sign speed limit



Second-row right seat belt unfastened, third-row right seat unoccupied or seat belt fastened



Road sign speed limit exceeded



Second-row right seat unoccupied or seat belt fastened, third-row right seat belt unfastened



Speed camera speed limit



Second-row right seat unoccupied or seat belt fastened, third-row right seat unoccupied or seat belt fastened



No road sign speed limit



Air suspension partial function failure



Air suspension stiffness adjustment fault



Air suspension severe fault



Charging cable connected



Battery fault



Scheduled charging enabled



Drive power limited



Steering system fault



Powertrain fault



Steering system severe fault



Motor and controller overheating



Steady on: Parking function activated
Flashing: Incorrect caliper status



Motor and controller fault



Steady on: Parking brake fault
Flashing: Parking system in service mode



Traction battery temperature too low



Auto Hold on



Traction battery temperature too high



Auto Hold fault



Traction battery charge too low



Brake system fault



Traction battery fault



Flashing: Electronic Stability Program activated
Steady on: Electronic Stability Program fault



Traction battery disconnected



Electronic Stability Program off



Forward Collision Warning Malfunction



Anti-lock Braking System fault



Forward Collision Warning Off



Hill Descent Control activated



The braking performance is degraded



Hill Descent Control fault



XPILOT ASSIST fault



Abnormal tire pressure or tire pressure monitoring system fault



Rear-wheel steering hardware fault



Lane Departure Assist fault



Rear-wheel steering fault



Lane Centering Control unavailable



Door open indicator



Maximum speed limit value for LCC/
NGP, with at least one of the functions
activated



Lane Centering Control activated



Maximum speed limit value for LCC/NGP, with both functions deactivated



Lane Centering Control available



Speed Assistance System activated



Advanced Parking Assist activated



Intelligent Navigation Guided Pilot activated



Advanced Parking Assist available



Intelligent Navigation Guided Pilot available



High-voltage system ready, vehicle is in a drivable state



Advanced Parking Assist unavailable



NGP nighttime speed limit is on



Intelligent Navigation Guided Pilot unavailable



NGP slippery road speed limit is on



Smart Chassis available



Smart Chassis activated

Page Display



1. Time
2. Power Battery
 - Displays the current driving range and remaining battery level.
3. Wi-Fi
4. Bluetooth
5. Driving Recorder



- Display the current Driving Recorder status
[See 307 page](#)
6. Account & Habits
 - After logging in, the account avatar is displayed.
 - Set your driving and vehicle usage habits.
 7. Driver Air Conditioner module
 - Displays the current temperature and air volume status of the driver air conditioner.
 - Tap to adjust the air conditioner
 8. Music module
 - Displays the cover art, title, and source of the currently playing media.
 - Tap to pause or resume Music playback.
 - Swipe left or right to play the previous or next track.
 9. Home
 - Tap to return to the home screen.
 - When on the home screen, tapping switches between split-screen and full-screen modes.
10. Set
 - Entry point for vehicle control settings.
 11. Music
 12. 360 View [See 297 page](#)
 13. App Center
 14. Volume Adjustment
 15. Front Passenger Air Conditioner module
 - Displays the current temperature and air volume status of the front passenger air conditioner.
 - Tap to adjust the air conditioner

i Tips

The font used by XOS is [MiSans].

Split-screen multitasking

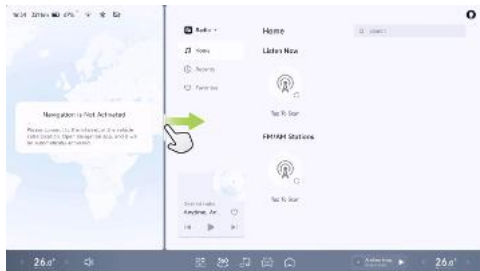

Drag the split line to toggle the full/split screen state and change the size of the form when split. When split-screen switches to full-screen, the last open split-screen application is remembered.

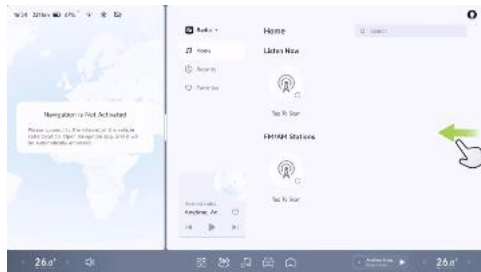

Swipe side to return to the page above the corresponding window.

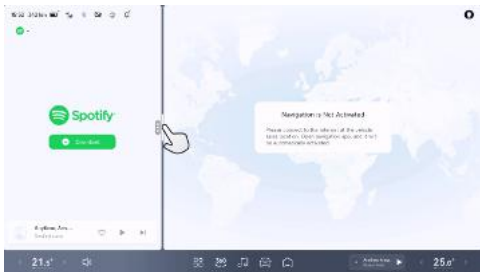

Tap the split-screen line to fix the small window App, supporting display of global smart drives, maps, and music.

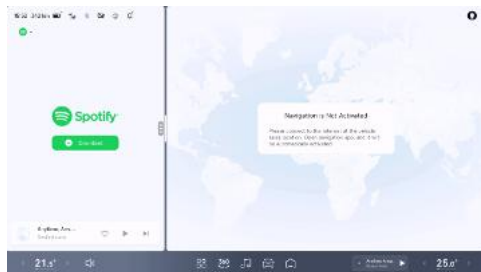
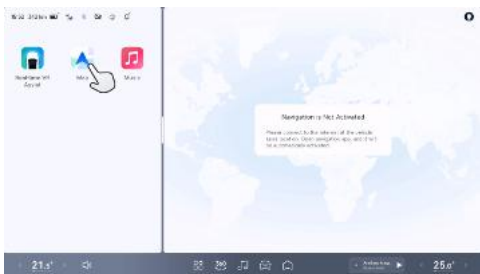

The large windows under split screen support different applications to open, the main drive to watch the navigation, the secondary drive to watch the video, listen to songs and read the lyrics.

Gesture interaction

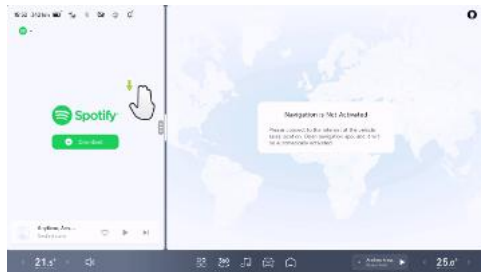

Three-finger swiping down allows exiting the app opened in the large window in the split screen mode and then returning to the corresponding homepage.

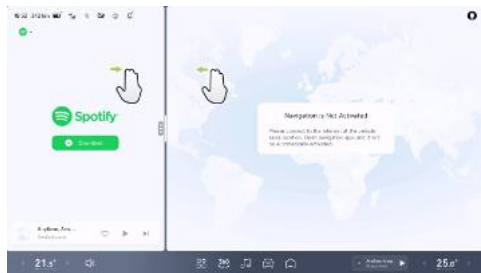

Three-/four-finger swiping left or right allows switch between different app windows. However, it doesn't work in full screen mode.

i Tips

This gesture is invalid for the bottom taskbar area. During the switch, the status bar and the bottom taskbar will not be hidden.



Customized bottom taskbar

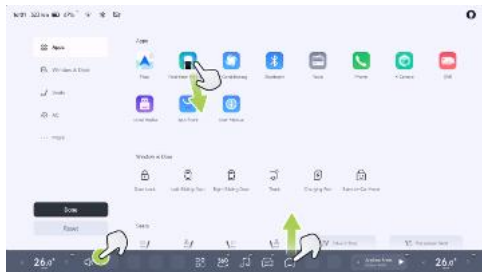

1. To customize the bottom taskbar, tap and hold the bottom taskbar icon or any area of the app list.
2. You can drag the function control and shortcut component icons in Apps, Doors & Windows, Seats, A/C and more to the blank at the bottom taskbar.
3. In the Custom status, tap  in the upper right corner or drag the icon to the App

Center and release to remove the icon from the bottom taskbar.

4. To exit Customization, tap in the bottom taskbar space, in the app list blank or tap **“Done”**.
5. You can tap **“Reset”** to restore the bottom taskbar to its default state.

App Center



1. Tap  in the bottom taskbar to open the App Center, and tap any blank space in the App Center to exit quickly.

2. Tap the app icon to open the app. Apps being downloaded and installed also have corresponding status display.
3. Tap and hold the app icon or blank space to enter the custom App Center status. At this time, you can drag the icon to sort in the app list.

Restart System

If the HUD, instrument panel, touchscreen, or rear entertainment screen displays abnormally or suddenly freezes, you can try restarting it. If the fault is not resolved after restarting, promptly contact an XPENG service center for inspection and repair.



Restart procedure:

1. Park the vehicle in a safe location and shift to P.
2. Press and hold the left button on the left side and the right button on the right side at the same time. Release them after the screen turns black to restart the HUD, instrument panel, touchscreen, or rear entertainment screen.



⚠ warning

Restarting the vehicle while it is in motion is prohibited and may cause a traffic accident.

Shortcut panel



For high-frequency functions, you can operate directly from the shortcut panel without opening the app. Swipe down from the top of the screen to unfold the shortcut panel, and swipe up to fold it. The shortcut panel is folded when you tap on a blank space or open a new screen.

Entertainment Screen

Introduction

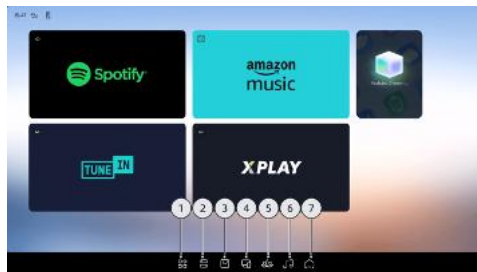

1. App Center
2. Shortcut panel
3. App Store
4. Screen Projection Assistant
5. Meditation Space
6. Music
7. Homepage

i Tips

The infotainment screen and CID share a third-party app, which does not support editing and sorting currently.

Turn Entertainment Screen On&Off

You can open/close the entertainment screen in the following ways:

- Press the entertainment screen switch on the sliding door to deploy/fold the entertainment screen.



- On the touchscreen, in the “ → **Settings** → **Display**” interface, you can deploy/fold the “**rear entertainment screen**” and set the deployment angle of the rear entertainment screen.
- Tap “” on the touchscreen to enter the Control Center interface, then tap “**Entertainment Screen**” to deploy/fold the rear entertainment screen.
- Customize the bottom taskbar on the touchscreen and add the “**Entertainment screen switch**” to the bottom taskbar. Tap the “**Entertainment screen switch**” icon in the bottom taskbar to deploy/fold the rear entertainment screen.
- Tap “” on the rear entertainment screen to open the quick panel, then tap “**Screen off**” to fold the rear entertainment screen.
- After the in-vehicle entertainment screen remote control is successfully connected to the vehicle, press the screen power button



on the remote to deploy/fold the rear entertainment screen.

- After waking up XPENG, speak your command, for example: “Open the rear entertainment screen,” “Close the rear entertainment screen.”

While the entertainment screen is deploying or folding, it will remain off until it has fully deployed or folded. When the entertainment screen is fully deployed, it will light up immediately.

If you touch the screen while the entertainment screen is deploying or folding, the screen will stop moving and will not move again until you perform another deploy/fold or angle adjustment operation.

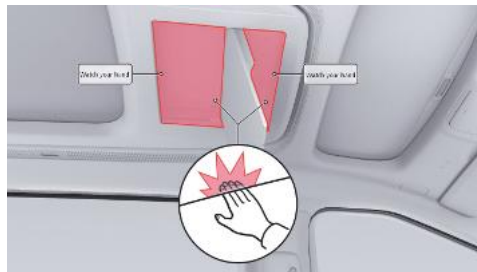



⚠ warning

- When unfolding or folding the entertainment screen, please keep items and body parts away from the screen's range of motion to avoid personal injury or property damage.
- When using the entertainment screen, please do not use external force to adjust the screen angle to avoid damaging the screen.



Adjust the entertainment screen deployment angle

You can set the rear entertainment screen deployment angle in the following ways:

- On the touchscreen, in the “ → **Settings** → **Display**” interface, set the deployment angle of the rear entertainment screen.
- Tap “” on the rear entertainment screen to open the quick panel, then slide “**Screen deployment angle**” to set the deployment angle of the rear entertainment screen.
- After the in-vehicle entertainment screen remote control is successfully connected to the vehicle, press the screen angle adjustment button on the side of the remote up or down to adjust the entertainment screen deployment angle.

Entertainment Screen Quick Panel



For high-frequency functions, you can operate directly from the shortcut panel without opening the app. You can tap the infotainment screen  , slide down from the top of the screen or use the remote control  to expand the shortcut panel of the infotainment screen. The shortcut panel is folded when you tap on a blank space or open a new screen.



Connect Bluetooth headphones

The rear entertainment screen can be connected to Bluetooth headphones. After a successful connection, audio played in the rear will be output through the Bluetooth headphones.

1. Tap “🔊” in the status bar of the entertainment screen to open the Bluetooth headphones connection interface.
2. Turn on the Bluetooth headphones switch; the system will automatically scan for and search nearby available devices.
3. Select the Bluetooth headphones you want to connect; the device will automatically complete pairing and connection.

App Center

1. Tap  to open the App Center. Tap any blank area within the App Center, or tap outside the App Center (except for the top status bar), to exit quickly.

2. Tap an App icon to open the App. Apps that are being downloaded or installed also display their corresponding status.
3. Press and hold an App icon or a blank area to enter the App Center customization mode. In this mode, you can drag icons within the app list to change their order.

Tips

The entertainment display and the touchscreen share the same set of third-party Apps.

Video and App Sharing

In applications that support content sharing, you can transfer video content among the touchscreen, HUD, and rear entertainment screen, and you can also share the application interface across screens between the touchscreen and the rear entertainment screen.



Video sharing

Open a video App on the rear entertainment screen and play your preferred audio/video content. Tap the App toolbar and select Share or Watch Together.

- In the toolbar, select Share, then select the Driver Display or HUD (supported only in P gear) to transfer the video and audio content currently playing on the rear entertainment screen to the touchscreen or HUD for playback.
- In the toolbar, select Watch Together, then select the Driver Display or HUD (supported only in P gear) to synchronize the video and audio content currently playing on the rear entertainment screen with the HUD or touchscreen.

i Tips

You can also swipe left with three fingers on the rear entertainment display to transfer the

audio/video content currently playing on the rear entertainment display to the touchscreen.

Share Application

Open an App that supports content sharing (using the "Music App" as an example). Swipe left from the right side of the screen with three fingers to share this App from the rear entertainment screen to the touchscreen.

In-vehicle Entertainment Remote Control

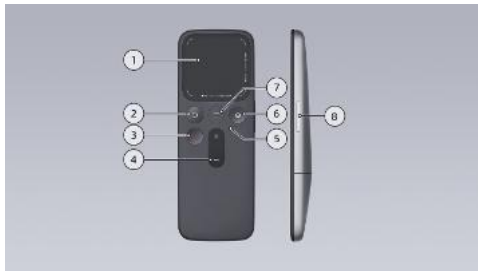



1. Touchpad

- Click: Press the touchpad to confirm an operation on the screen.
- Swipe: Slide your finger on the touchpad to control the cursor on the screen.
- Swipe along the edge: Slide up and down along the right edge of the touchpad to scroll the page vertically, and slide left and right along the bottom edge to scroll the page horizontally.

Tips

For best results, hold the touchpad close and swipe slowly to slide and scroll.

2. Back button: Press to return to the previous screen.
3. Screen power button: Turn the entertainment screen on or off.
4. Volume +/- buttons: Press “+” to increase the volume, and press “-” to decrease the volume.
5. Indicator light: When any button is pressed, a blue light indicates sufficient battery power; a

red light indicates low battery power. Replace the battery promptly.

6. Home button: Press to return to the home screen.
7. Quick access button: Press to enter the quick access screen.
8. Adjust screen angle: Press up or down to adjust the opening angle of the entertainment screen.

Pairing

When the remote control is not connected, tap “” in the status bar at the top of the entertainment screen. After the pop-up window appears, press and hold the remote control “**Back button**” and “**Home button**” simultaneously for more than 3 seconds to enter pairing mode. Once the system detects the remote control, pairing will be completed automatically without any further operation.

i Tips

- Before using the remote control for the first time, remove the battery tab by opening the back cover so the remote can operate normally.
- If the entertainment screen does not respond when operating the remote control, first check the indicator light on the remote. If the indicator light turns blue when a button is pressed, try pairing again. If the indicator light turns red, replace the battery and then try pairing again.
- After use, it is recommended to store the remote control in the seatback magazine pocket of the front seat.

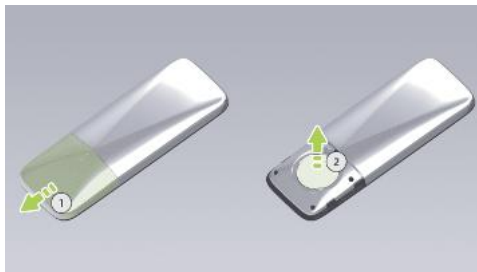
Replacing the remote control battery

1. Slide open the back cover.
2. Remove the key battery. Battery model: CR2450.
3. Install in the reverse order. Before installation, wipe the surface of the battery clean; otherwise, fingerprints may affect the service life of the battery. When installing, make sure the “+” (positive) side of the key battery is facing up.

**⚠ caution**

- Dispose of used batteries properly, incorrect disposal of used batteries can damage the environment.
- Do not use sharp objects to remove the key fob, as this may damage the key fob.

⚠ warning

Keep the battery out of reach of children, and if children ingest it, it could cause serious injury or death.

Head-Up Display (HUD)

Function Overview

Head-Up Display System Interface Overview

The Head-Up Display system (HUD) projects information needed by the driver onto the front windshield, allowing the driver to view navigation, speed limit signs, vehicle speed, and other information without taking their eyes off the road.

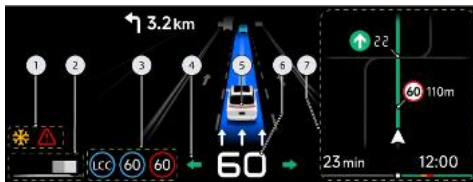

1. Snow Mode, safety warning indicator lights
2. Vehicle information such as battery level and driving range, Air Conditioner airflow and temperature adjustment, volume adjustment, switching driving modes, etc.
3. Driving assistance function indicator lights (for example: Navigation Guided Pilot available indicator, speed limit sign / speed limit indicator, etc.)
4. Turn Signals
5. Environment perception information (displays the external road environment and the vehicle's current status, and provides real-time information on perceived road conditions, other traffic participants, etc.)



6. Vehicle speed or gear position
7. Navigation information

i Tips

- When the battery is low, the HUD will issue a low-battery alert to remind the driver to charge the vehicle in a timely manner.
 - When the remaining range corresponding to the state of charge is less than 60 km, the range bar will turn yellow and display a warning message.
 - When the remaining range corresponding to the state of charge is less than 30 km, the range bar will turn red and display a warning message.
- When the vehicle is charging, the range bar will be displayed in green.
- When the vehicle is in Park (P), you can check the open/closed status of the four doors and two lids.

Turn HUD On&Off

On the touchscreen, go to “ → **Settings** → **Display**” to turn the HUD head-up display on or off. When the function is turned off, the HUD does not project any content.

i Tips

- When the low power saving function is enabled, the HUD will not display safety warning information until the function is disabled.
- When the ultimate power saving mode is enabled, the HUD function will be automatically turned off. Users can still manually turn the HUD function on. After exiting the ultimate power saving mode, the system will revert to its previous state. If the HUD function was manually turned on while the ultimate power saving mode was active, it will remain on after exiting the mode.
- When the driver's meditation mode, sleep mode, waiting mode, or rescue mode



is activated, the HUD function will be automatically turned off. After exiting the function, the system will return to the state before it was activated.

- The HUD function will remain on or off after the passenger meditation mode is activated, the screen is cleaned, or the SOS function is triggered.

Adjust HUD Height, Brightness, and Angle

1. After correctly adjusting the seat position. On the touchscreen, go to “ → **Settings** → **Display**” to open the brightness, height, and angle adjustment interface.
2. You can use the steering wheel buttons and rollers to adjust the HUD height, brightness, and angle respectively.

Tips

After manually adjusting the HUD height and angle, the settings will be saved to

the driving habits of the currently logged-in account. If guest mode is enabled, the settings will be saved locally.

Brightness Adjustment

When the HUD adjustment interface is displayed on the touchscreen, you can adjust the HUD brightness by rolling the right-hand steering wheel roller.

- **Brighter:** Roll the right-hand steering wheel roller upward.
- **Darker:** Roll the right-hand steering wheel roller downward.

Tips

HUD brightness is set to automatic adjustment by default.

Height Adjustment

When the HUD adjustment interface is displayed on the touchscreen, you can adjust the HUD height by rolling the left-hand steering wheel roller.



- **Raise:** Roll the left-hand steering wheel roller upward.
- **Lower:** Roll the left-hand steering wheel roller downward.

Angle Adjustment

When the HUD adjustment interface is displayed on the touchscreen, press the left and right buttons on the left side of the steering wheel to manually adjust the left/right rotation angle of the HUD image.

- **Rotate counterclockwise:** Press the left button on the left side of the steering wheel.
- **Rotate clockwise:** Press the right button on the left side of the steering wheel.

Adaptive Height Adjustment

1. On the brightness, height, and angle adjustment interface on the touchscreen, tap the “**Adaptive Height Adjustment**” button.
2. Follow the voice prompts to maintain a correct sitting posture and look straight ahead; the system will then automatically

adjust the HUD to the most suitable position based on the driver’s posture and eye height.

3. If the adjustment fails, adjust your sitting posture again, maintain a correct sitting posture and look straight ahead, then tap “**Readjust**”. The system will automatically adjust to the most suitable position based on the driver’s posture and eye height.

Tips

After the adaptive height adjustment is complete, if the head-up display content you see is incomplete, you can scroll the left scroll wheel on the steering wheel to adjust the head-up display interface to a suitable height.

Set HUD Display Mode

On the touchscreen, go to “ → **Settings** → **Display**” to switch the HUD display mode. You can choose from three display modes: **Map Mode**, **Perception Mode**, and **Minimal Mode**.



Minimal Mode

When Minimal Mode is selected, only basic information, driving assistance indicator lights, brief navigation information, and similar content will be shown.

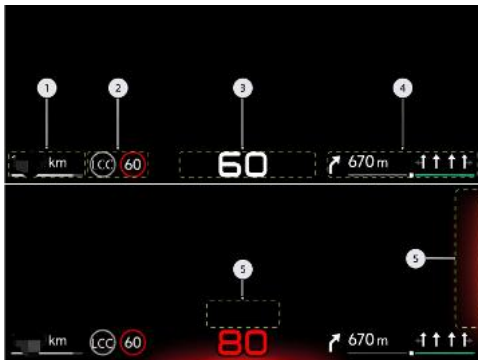

1. Information such as remaining range, air conditioner airflow and temperature settings,

volume adjustment, and driving mode selection.

2. Driving assistance indicator lights (for example, the Navigation Guided Pilot indicator, speed limit sign indication, etc.).
3. Information such as vehicle speed, turn signals, and gear position.
4. Brief navigation information.
5. Safety assistance warning messages (for example, overspeed alerts, cut-in alerts from adjacent vehicles, etc.).

Perception Mode

When Perception Mode is selected, SR environment simulation, Lane-level Navigation guidance, safety assistance warnings, and other information will be displayed.

1. Manual driving mode with navigation enabled, but Lane-level Navigation not activated.
2. Manual driving mode with navigation enabled and Lane-level Navigation activated.

- Lane-level Navigation and assisted driving functions are activated.

warning

For reference only, It is not intended to replace the operator's view of the surrounding environment. — to control the vehicle. Failure to do so could result in injury.



When switching from Minimal Mode or Map Mode to Perception Mode, if the switch requires a change of instrument cluster mode, a pop-up will appear. After you confirm, the HUD will switch

to Perception Mode and the instrument panel will switch to Map Mode to provide complementary information.

Map mode

When Map Mode is selected, complete map information, safety assistance warnings, and other information will be displayed.

- Full-Screen Map Display Mode.
- Safety assistance warning messages (for example, overspeed alerts, cut-in alerts from adjacent vehicles, etc.).





When switching from Minimal Mode or Perception Mode to Map Mode, if this switch causes the instrument panel mode to change, a pop-up will appear. After you confirm, the HUD will switch to Map Mode, and the instrument panel will switch to Smart Drive Mode to provide complementary information.

Display

On the touchscreen “ → **Settings** → **Display**” screen, you can turn Map Display on or off. When the HUD display mode is set to Map Mode, the map display switch will be hidden.

1. Map display On: The road network is shown on the navigation map.
2. Map display Off: The road network is not shown on the navigation map.

Large View of Real Intersections

On the touchscreen “ → **Settings** → **Display**” screen, you can turn Large View of Real Intersections on or off.

1. When Large View of Real Intersections is switched on, enlarged junction views are shown in the navigation display.
2. When Large View of Real Intersections is switched off, enlarged junction views are not shown in the navigation display.

Snow Mode

On the touchscreen “ → **Settings** → **Display**” screen, you can turn Snow Mode on or off. After Snow Mode is turned on, the HUD color changes to orange to make information clearer when driving in snowy conditions.

1. When Snow Mode is turned on, the primary color changes to orange.
2. Turn off Snow Mode.

Intelligent Height Adjustment

Make sure that the HUD head-up display function is turned on. On the touchscreen “ → **Settings** → **Display**” screen, you can turn Intelligent Height Adjustment on or off.

After this function is turned on, when you actively adjust the driver's seat (such as fore-and-aft position, height, or seatback angle), the system will detect the driver's current eye height and automatically adjust the HUD height to a suitable position.

i Tips

The automatic height adjustment function may not be triggered in the following situations, including but not limited to:

- The driver's seat welcome function causes the driver's seat to move.
- After logging into the account, the driver's seat was moved due to switching user habits.
- The driver's seat backrest angle is adjusted too far back.
- After getting out of the driver's seat, adjust the driver's seat.
- The charging gun is connected.

HUD Turn-Signal View

On the touchscreen “ → **Settings** → **Intelligent Imaging**” screen, after turning on Activate Side Rear Image When Turning, you can set the image display position to HUD.

When the vehicle is in D and a turn signal is activated, the HUD automatically displays the corresponding side rear image to help you check the side rear blind spot and assist driving.



⚠ warning

Rear View on the steering active side is an assistance function for reference only and does not replace the driver's view of the surrounding environment. You are responsible



for driving safely as the driver of the vehicle, and do not rely on this feature to control the vehicle. Failure to do so could result in injury.

rely on this function to control your vehicle, as this may result in injury.

HUD Intelligent Narrow Road Image

On the touchscreen “ → **Settings** → **Intelligent Imaging**” screen, you can turn HUD Intelligent Narrow Road Image on or off.

After this function is turned on, when the vehicle is in D and there is a risk of scraping while driving through a narrow road, the HUD will automatically display the surround view image.

warning

- HUD intelligent narrow-lane imaging is an assistive function that can only provide a reference and cannot replace the driver's observation of the surrounding environment.
- The HUD intelligent narrow-lane imaging system cannot handle all traffic, weather, and road conditions. As the driver, you are responsible for your driving safety. Do not

HUD Rear View



Activation: When the gear position is shifted to Reverse (R), the HUD will automatically display the rear view image.

Deactivation: When the gear position is shifted to any other gear, the HUD will automatically exit the reversing image display and return to its previous state.

**⚠ warning**

- When reversing, please make full use of the interior rearview mirror, exterior rearview mirror, 360-degree camera, and HUD reversing camera to observe the surrounding environment of the vehicle and prevent accidents.
- HUD (Head-Up Display) is an auxiliary function that provides only reference and cannot replace the driver's observation of the surrounding environment. HUD cannot handle all traffic, weather, and road conditions. As the driver, you are responsible for your driving safety. Do not rely on this function to control the vehicle, as this may result in injury.

⚠ warning

Objects in the HUD reversing camera image may be distorted compared to the actual objects. The HUD reversing camera may not function properly in the following scenarios:

- Camera restrictions.

- The camera is obstructed (dust, covering, etc.), or the weather conditions are unfavorable (such as heavy rain, heavy snow, dense fog).

HUD Viewing Mode



Open a video App from the App Center on the touchscreen or on the rear entertainment screen, play your preferred audio/video content, tap the floating button, and select Share or Watch Together.



- In the pop-up, select Share, then select HUD (available in P only) to transfer the audio/video content currently playing on the touchscreen or rear entertainment screen to the HUD for playback.
- In the pop-up, select Watch Together, then select the driver display or HUD (available in P only) to synchronize the audio/video content currently playing on the touchscreen with the HUD or the rear entertainment screen.

i Tips

You can also use a three-finger swipe gesture on the central control screen to transfer the audio and video content playing on the central control screen to the HUD for playback. For more central control screen gesture operations, please see the central control screen section.

Set Viewing Mode



1. Short press to play the previous audio/video item.
2. Scroll up or down to adjust media volume; short press to play or pause the audio/video content.
3. Short press to play the next audio/video item.

i Tips

The audio and video playback can be controlled using the buttons on the right side of the steering wheel. For more information on

steering wheel button operations, please see the steering wheel section.

Exit Viewing Mode

You can exit the HUD viewing function in the following ways; the content you are watching will be transferred to play on the touchscreen:

1. Tap the video App on the touchscreen to exit the HUD viewing function.
2. Shift from P to another gear to exit the HUD viewing function.

Tips

For safety reasons, the HUD viewing function can only be used in P mode. Switching from P mode to other modes will deactivate the HUD viewing function.

Clean HUD

To ensure optimal HUD performance, regularly use a clean, dry microfiber cloth to gently wipe dust or dirt from both the inside and outside

of the windshield and the HUD system area. For stains that are difficult to remove, slightly moisten the microfiber cloth before wiping.



3

HUD Usage Notes

- Check and confirm that the position and brightness of the HUD system do not interfere with safe driving.
- Do not continuously stare at the HUD system while driving; otherwise, you may fail to see pedestrians and objects on the road ahead of the vehicle.



- Do not place any liquids near the HUD system. If the HUD system becomes wet, it may cause an electrical malfunction.
- Do not place any objects or stickers on the HUD system or in the projection area on the windshield, otherwise the HUD display may be interrupted.
- Do not touch the HUD system or throw objects with sharp edges into the interior of the HUD system. Otherwise, mechanical failure may occur.
- Do not use windshield films with poor light transmittance or very dark colors, otherwise the display performance of the HUD system may be affected.
- Poor windshield film installation that results in bubbles or wrinkles will also affect the display performance. It is recommended that you visit an XPENG service center or an XPENG-authorized partner outlet to have installation performed by professionally trained technicians.

! caution

Some sunglasses may affect the reading of the Head Up Display (HUD) information, please remove the sunglasses when adjusting the Head Up Display.

! caution

If the front windscreen needs to be replaced, go to the XPENG Service Centre to replace the special windscreen, to avoid affecting the imaging of the Head-Up Display system.

XPENG App

Download XPENG App

The XPENG App can be downloaded as follows:

- Android/iOS mobile users can search for “XPENG” in the built-in App store to download and install it.

Vehicle Control Functions

On the XPENG page in the XPENG App, you can perform the following controls for the vehicle:



1. Vehicle status and shortcut bar: View vehicle status information such as remaining driving range and door status. Quickly enable required functions in the shortcut bar.
2. Digital Key: Check the connection status between the Bluetooth key and the vehicle. Enter the Digital Key interface to create or delete a mobile App key and perform related settings.
3. Locate Vehicle: View the real-time location of the vehicle (owner account only); flash the lights and sound the horn to help locate the vehicle.
4. Charging Center: Enter the Charging Center interface to view nearby charging station locations, charging records, and other information.
5. Intelligent Air Conditioner: View the cabin temperature. Enter the air conditioner interface to remotely turn the air conditioner on or off and set air conditioner functions.
6. Sliding Door Control: Open/close the left and right sliding doors.
7. Auto Parking: Use parking functions such as Remote Vehicle Summons, Remote Parking, and Auto Exit. For details, refer to the Parking section.
8. Intelligent Imaging: Turn on/off XGUARD; view desensitized real-time images around the



vehicle (owner account only) and high-risk sentry recordings from the past 7 days in desensitized form.

9. More Functions: Check tire pressure; set the activation duration of the in-vehicle power supply; open/close the rear electric sunshades; turn the refrigerator cooling or heating function on/off; turn the low-temperature battery preheating function on/off; adjust settings after binding the home charger; plan long-distance routes based on maximum range; send any address to the touchscreen for navigation.
10. X-Combo: Add, delete, or create Combos.
11. Driving Data: View average energy consumption and recent trip records (owner account only).

i Tips

- The XPENG interface uses the standard style by default. You can adjust the XPENG interface style in Settings and choose either “Standard Style” or “Classic Style.”

- When the mobile key is connected to the vehicle via Bluetooth, it can be used even in environments without network signal, such as garages.
- The vehicle is equipped with both media Bluetooth and key Bluetooth. The mobile key will automatically connect via Bluetooth without pairing on the touchscreen.
- Under normal conditions in open areas, the Bluetooth connection range is about 20 meters, but this may vary due to factors such as the mobile Bluetooth hardware, environmental obstructions, and interference.

Custom Shortcut Bar

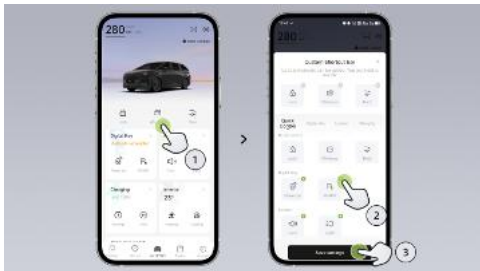

1. Press and hold a function icon in the shortcut bar to customize the shortcut bar.
2. In custom mode, tap the “+” in the upper-right corner of a function icon to add functions such as Quick Control, Digital Key, and Park & Locate to the custom shortcut bar. Press and hold a function icon in the custom shortcut bar, then drag the icon to adjust its order.
3. Tap “Save Settings” to exit custom mode.

i Tips

You can place up to 8 functions in the shortcut bar, and at least 1 function must be retained.

Combo Modes

Camping Mode

Introduction

When you are traveling or on an outing, you can enable Camping Mode. After it is enabled, Power Off Automatically and automatic lock/unlock functions are temporarily disabled, and the range extender is disabled to provide a more comfortable and convenient outdoor vehicle experience.

Enabling Camping Mode

When the conditions for enabling Camping Mode are met, you can enable Camping Mode using any of the following methods:

- Use a voice command directly (for example, say “Hi, XPENG, turn on Camping Mode”).



- In the touchscreen, tap **“Combo Modes→Camping Mode”** to enable Camping Mode.

Before enabling Camping Mode, make sure the vehicle meets the following conditions:

- The gear position is in P.
- Remaining driving range is above 10%.
- Pet Mode and P-Comfort Mode are not enabled.
- The vehicle is not in a system update state.

Exit Camping Mode

After Camping Mode is enabled, you can exit Camping Mode in any of the following ways. After exiting, Power Off Automatically and automatic lock/unlock are restored, and the range extender is re-enabled:

- Use a voice command directly (for example, say “Hi, XPENG, exit Camping Mode”).
- On the Camping Mode screen of the touchscreen, tap **“X”** to exit Camping Mode.

Camping Mode will exit automatically when any of the following conditions is met:

- Remaining driving range is below 10%.
- The gear position is shifted out of P.
- The vehicle is powered off in an emergency via the touchscreen.
- The vehicle is powered off in an emergency via the SOS switch.
- The vehicle is locked using the mobile App or the NFC key.

X-Combo

X-Combo allows you to customize cabin functions based on your personal preferences. For example: at noon on a workday, when the vehicle is at your workplace, you can turn on the remote air conditioner in advance to adjust the cabin temperature, and after you get in the vehicle, the seat position is automatically adjusted to a nap mode.

**! caution**

To ensure a smooth user experience, it is recommended that the XPeng Motors App be upgraded to version 5.0.0 or higher. The vehicle's infotainment system needs to be upgraded to version 5.4.0 or higher.

Feature entry point in the touchscreen

Tap “” in the touchscreen, then tap “**X-Combo**” in the App Center to enter the X-Combo screen.

Selecting Combos

X-Combo offers a curated selection of creative and practical vehicle-use Combos. You can select them on the “**Recommend**” screen. Tap a “**Combo Card**” to view its details. After logging in to your account in the touchscreen, tap “**Add**” to add it to My Combo. In the search box in the upper-right corner, you can search for Combo cards by Combo code or keyword.

My Combo

After logging in to your account in the touchscreen, you can enable, disable, delete, restore, and run Combos.

Combo Editing

X-Combo allows you to customize and edit the cards in My Combo.

1. After logging in to your account in the touchscreen, on the My Combo screen, tap a Combo card to enter the card details screen.
2. Tap .
3. Use the XPENG App to search for the Combo code or scan the QR code to edit it.

i Tips

After the scene is changed, both the vehicle's infotainment system and the mobile device need to be connected to the internet for the update to be synchronized.



Running and Viewing

Once enabled, a Combo automatically performs the corresponding one or more consecutive functions after the vehicle meets the preset trigger conditions. You can tap **"X-Combo Running"** in the status bar at the top of the touchscreen to view, stop, or resume the Combo that is currently running.

"One-click Restore"

Both while an X-Combo is running and after it has run, you can restore the vehicle to the state before the Combo ran as follows:

- While a Combo is running, tap **"Restore"** on the X-Combo card in the lower-left corner of the touchscreen to stop the Combo and restore the vehicle to the state before the Combo ran.
- While a Combo is running, you can also tap in the touchscreen in sequence:  **→X-Combo→My Combo**, then tap the corresponding Combo and tap **"Restore"** to

stop the Combo and return to the state before it started.

- After a Combo has finished running, you can tap in the touchscreen in sequence:  **→X-Combo→My Combo**, select the Combo you want to restore, and tap **"Restore"** to stop the Combo and return to the state before it started.

Tips

Currently, the supported recovery capabilities include air conditioning, seat position, and screen display. More recovery capabilities will be added in future versions.

Mobile App feature entry point



In the XPENG App “XPENG→X-Combo”interface, you can configure your exclusive Combos.

Selecting Combos

X-Combo offers a curated selection of creative and practical vehicle-use Combos. You can browse them on the “Recommend” screen. Tap a “Combo Card” to view its details, and tap “+Add to Mine” to add it to My Combos. You can also adjust them based on your own driving and usage habits via “Edit”. In the search box in the

upper-right corner, you can search for Combo cards by Combo code or keyword.

i Tips

After the scene is changed, both the vehicle's infotainment system and the mobile device need to be connected to the internet before they can be updated synchronously.

Personalized customization

X-Combo supports personalized customization of cabin functions. Tap “**X-Combo**→→**Create Combo**” to start personal customization.

The system provides two trigger modes for running Combos: “**In-vehicle trigger**” and “**Remote trigger**”. It supports using voice, time, location, environment, multimedia playback, vehicle status, etc. as trigger conditions for automatic operation, and also supports configuring a wide range of actions, such as XPENG Q&A, driving mode adjustment, air conditioner settings, and more.



You can also use the “**Advanced**” settings to implement higher-level application scenarios such as continuous sensing and evaluation of multiple conditions, simultaneous execution of multiple tasks, and delayed execution of commands.

caution

- Always keep the vehicle and personnel safe while the scenario is running.
- It is recommended to “select “**Intelligent Query**” Mode when creating Combos. The combo task will then determine the level of safety of the combo based on the state of the vehicle before it is carried out at the end of the vehicle, if there is a road safety risk (e.g. adjusting the driving mode in D). A Xpeng smart recommendation card in the CID will be used to ask if the combo is to be executed if “**do not query**”, The combo is performed immediately when the trigger condition is met, be aware of the associated security risks.

Combo sharing

Combos under “**My**” support sharing. Tap “...” on a “**Combo Card**” to share it with one tap or share it externally as a link. After others tap the Combo link, they can view its details; once they enter the XPENG App, they can tap Done to save the Combo, and may also edit and adjust it as desired, then enable it to run.

You can also go to “**Combo Visibility**” at the bottom of the “**Edit Combo**”/ “**Create Combo**” page and enable “**Participate in recommended Combo selection**”, which means you agree to participate in the selection of high-quality Combos. High-quality Combos you create will be periodically selected and displayed on the feature’s “**Recommend**” Combo screen for XPENG friends to choose and enable.

Tips

The scenario sharing and execution capabilities between different vehicle models are subject to the actual functions that the vehicle can support.



Difference between “Until the condition is met” and “If the status is”

The “**Until the condition is met**” operation is based on continuous sensing of the condition variables after the Combo is triggered. After the Combo is triggered, the vehicle will continuously sense the configured condition variables until they are met, and then execute the corresponding action.

For example, if a Combo is configured so that after the vehicle shifts to D Gear, when the cabin temperature rises above 27°C the seat ventilation will turn on, then after the vehicle shifts to D Gear, if the set temperature is not reached in the short term, X-Combo will continue to monitor the cabin temperature and will execute the seat ventilation operation once the temperature exceeds 27°C.

The “**If the status is**” operation is based on evaluating the condition only at the moment the Combo is triggered. If the configured condition status is met, the corresponding action is executed; if the trigger condition status is not

met, the system will not continue sensing or evaluating it, and the corresponding action will not be executed.

For example, if a Combo is configured so that when the vehicle shifts to D Gear, the seat ventilation turns on when the cabin temperature is higher than 27°C. When the vehicle shifts to D Gear, if X-Combo detects that the cabin temperature has not yet exceeded 27°C, the configured seat ventilation task will not be executed. Even if the cabin temperature later rises above 27°C, the seat ventilation task will still not be executed.

System Update

Function Overview

The vehicle supports updates via the touchscreen or the mobile App to provide the latest features. It is recommended that you update the system as soon as possible after receiving a new version notification.



Tips

- Make sure the vehicle is connected to the network and will not receive updates until the vehicle is connected to the network.
- The traffic consumption resulting from the system updates is borne by Xpeng Motors, the vehicle package traffic will not be used, the user will not be responsible for the system update traffic cost.
- If you have any further questions, please contact the Xpeng Car Service Center or the Customer Service Center.

View system version

On the touchscreen “ → **Settings** → **General**” screen, tap the top “**XOS version number**” to view details of the current in-vehicle system version.

Update notification

When a new version is available, an  update icon will appear in the status bar at the top of the touchscreen.

Update via the touchscreen

After tapping the  icon on the touchscreen, you can select the system update method.

- **Update now:** After tapping, the vehicle will start updating immediately. The vehicle cannot be used during the update. Make sure the vehicle is parked in a safe area and allow sufficient time.
- **Schedule update:** After tapping, you can set the update time. When the set time is reached and the vehicle is locked, the system will update automatically.

Update via the mobile App

After receiving a new version update notification, tap **Update** in the mobile App and the vehicle will start updating immediately.



Automatic update at 3:00 a.m.

On the general interface of the touchscreen, tap **Update Settings** to enable the automatic update function. Once enabled, when the vehicle detects that a new version is available, it will begin updating at 3:00 a.m. without manual confirmation.

Notes and Limitations

- Before updating, make sure the vehicle has more than 10% remaining charge, is in Park (P), and is parked in a safe area.
- Once the update starts, it cannot be stopped. The vehicle cannot be used during the update. Please allow sufficient time for the update to complete.
- The vehicle cannot be charged during the update. Please plan the update and charging times appropriately.
- A system update failure may cause some functions to operate abnormally. If the update fails, do not use the vehicle. Tap **Retry** to

try the update again. If multiple retry attempts are unsuccessful, contact an XPENG service center or the customer service center.

- After the system is updated, it cannot be rolled back to a previous version.



Wireless Casting

Function Overview

Wireless Screen Casting does not require any cables. After your device is connected to the “**In-vehicle Hotspot**”, you can cast the screen content of your Android or iOS device to the touchscreen, allowing you to enjoy entertainment content from your own device in the vehicle along with an excellent audio-visual experience.

1. Tap “

Tips

Online video playback consumes the car's data. To change the screen mirroring method, click on the central control screen. “**Other connection methods**” View and connect.

3. Video casting:

- After selecting a video in the video App, tap “

Tips

Select a screen name that matches your currently logged-in account name, and then select the corresponding screen name to start screen mirroring.

- Tap the screen once to pause or resume the current video.
 - Swipe up or down on the left side to adjust the screen brightness.
 - Swipe up or down on the right side to adjust the media volume.
5. Tap the screen, then tap “**Exit Screen Casting**” in the upper left corner to exit casting.



Wired screen Casting

Function Overview

The system supports Wired Screen Casting, allowing you to easily project the display of devices such as game consoles and computers (including Switch, MacBook, etc.) onto the vehicle's large screen for an unprecedented visual experience.

1. Tap “” in the touchscreen, then tap “**Wired Screen Casting**” in the App Center.
2. Use an HDMI cable and a video capture card to connect to the front Type-C or Type-A port.

Tips

The Switch requires an additional PD charging cable for power. One end of the charging cable is inserted into the video capture card or HDMI port, and the other end is connected to the vehicle's USB-C port.

3. Once the connection is successful, the image will be displayed on the screen.
4. Wired Screen Casting:
 - Swipe up or down on the left side to adjust the screen brightness.
 - Swipe up or down on the right side to adjust the media volume.
 - Touch-to-mute is supported.
5. Tap the screen, then tap “**Exit Screen Casting**” in the upper left corner to exit casting.

Tips

Sony PS, Xbox, and other similar devices have high voltage requirements, so it's not recommended to use the car's internal power port for screen mirroring. However, you can use the external power port to power the device while parked for screen mirroring.



HUAWEI HiCar* (If applicable)

Function Overview

HUAWEI HiCar supports connection between Huawei mobile and the vehicle system. After a successful connection, compatible mobile Apps can be cast to the vehicle system for use.

First-time connection

First-time mobile-vehicle connection:

1. Tap “” in the touchscreen, then tap “**HUAWEI Hicar**” in the App Center to enter the connection interface.
2. Enable Wi-Fi and Bluetooth on your mobile and bring it close to the touchscreen. Follow the connection request pop-up on your mobile and enter the PIN code to complete the connection, then confirm on the mobile whether to enable “**Auto-connect**”.

i Tips

If the first connection fails, you can try to recover in the following ways:

- Click “”the Reconnect button to reconnect.
- After power down, reconnect after attempting to power up again.

The PIN code is automatically refreshed over 60s and can be refreshed immediately by tapping the button.

3. After the connection is successful, tap “**Go to App list**” to enter the App list and view and use casting Apps.

Subsequent connections

For subsequent connections, if “**Auto-connect**” is enabled on the mobile: enable Wi-Fi and Bluetooth on your mobile and bring it close to the touchscreen to automatically establish the mobile-vehicle connection.



For subsequent connections, if “**Auto-connect**” is not enabled on the mobile:

1. Enable Wi-Fi and Bluetooth on your mobile and bring it close to the touchscreen.
2. On the integrated home screen, select whether to connect to a previously connected device or to a new device.

If you choose to connect to a previously connected device, simply tap the corresponding device to connect successfully.

If you choose to connect a new device, select the type of device to connect, then follow the connection request pop-up on your phone and enter the PIN code to complete the connection.

Shortcut bar

Tap the  icon in the upper-right corner of the touchscreen to quickly operate mobile-vehicle connection functions. You can quickly switch, disconnect, or connect to other devices.

ICCOA Carlink* (If applicable)

Function Overview

ICCOA Carlink supports connecting mobile from multiple brands such as OPPO, vivo, and Xiaomi to the vehicle system. After a successful connection, compatible mobile Apps can be cast to the vehicle system for use.

First-time connection

First-time mobile-vehicle connection:

1. Tap “” in the touchscreen, then tap “**ICCOA Carlink**” in the App Center to enter the connection interface.
2. Enable Wi-Fi and Bluetooth on your mobile and bring it close to the touchscreen. Follow the connection request pop-up on your mobile and enter the PIN code to complete the connection, then confirm on the mobile whether to enable “**Auto-connect**”.



i Tips

If the first connection fails, you can try to recover in the following ways:

- Click “”the Reconnect button to reconnect.
- After power down, reconnect after attempting to power up again.

The PIN code is automatically refreshed over 60s and can be refreshed immediately by tapping the button.

3. After the connection is successful, tap “**Go to App list**” to enter the App list and view and use casting Apps.

Subsequent connections

For subsequent connections, if “**Auto-connect**” is enabled on the mobile: enable Wi-Fi and Bluetooth on your mobile and bring it close to the touchscreen to automatically establish the mobile-vehicle connection.

For subsequent connections, if “**Auto-connect**” is not enabled on the mobile:

1. Enable Wi-Fi and Bluetooth on your mobile and bring it close to the touchscreen.
2. On the integrated home screen, select whether to connect to a previously connected device or to a new device.

If you choose to connect to a previously connected device, simply tap the corresponding device to connect successfully.

If you choose to connect a new device, select the type of device to connect, then follow the connection request pop-up on your phone and enter the PIN code to complete the connection.

Shortcut bar

Tap the  icon in the upper-right corner of the touchscreen to quickly operate mobile-vehicle connection functions. You can quickly switch, disconnect, or connect to other devices.



Apple Carplay* (If applicable)

Function Overview

Apple CarPlay allows users to access services more safely and conveniently while driving by mapping core iPhone functions to the CID.

1. Enter “APP center”and click “Apple CarPlay”



Activate Apple CarPlay according to the guideline on CID



- a. Method 1: Match your phone's Bluetooth in the Bluetooth listpage.
- b. Method 2:Connect your iPhone with a USB cable.

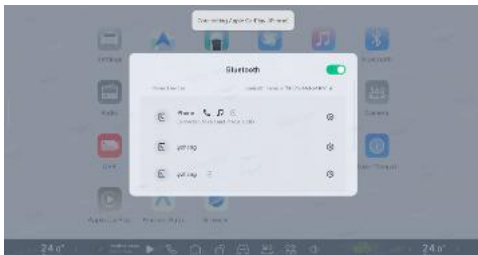



Quick Vehicle Locate

Long-distance Vehicle Locate (Owner Account Only)

When you are far from the vehicle or do not know where it is parked, you can use the “**XPENG**→**Vehicle Location/Map**” screen in the mobile App to check the vehicle’s parking location information.

1. Tap Navigate to generate a route for locating your vehicle.
2. After tapping the location information, you can view photos of the area around where the vehicle is parked.
3. Tap Camera to view video of the area around the vehicle.

Locate Vehicle at Close Range via XPENG App

When you are close to the vehicle (for example, in a residential parking lot), use the “**XPENG**” App on your mobile and select horn or light

flashing as a prompt so you can quickly locate the vehicle.

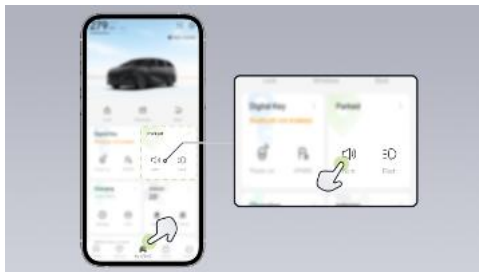

5

Lock&Unlock Feedback

Vehicle Lock&Unlock Feedback

In the touchscreen, in the “ →**Settings**→**Vehicle**→**Lock/Unlock & Welcome**” interface, you can set the lock and unlock alert methods.



- **Flash lights:** When the vehicle is unlocked, the turn signals will flash twice. When the vehicle is locked, the turn signals will flash once.
- **Flash lights + horn:** While the turn signals are flashing, a horn sound will be emitted.
- **Flash lights + chime:** While the turn signals are flashing, a music chime will be emitted.

Pop-out Handles on Unlock

You can enable/disable the “**Auto door handle deployment on unlock**” function in the “ →Settings→Vehicle→Lock/Unlock & Welcome” interface in the touchscreen. When this function is enabled, the front door handles will automatically deploy when the vehicle is unlocked.

warning

When using the door handles, be careful that fingers, jewelry, acrylic nails, etc. are not trapped by the door or door handle mechanism. Failure to do so could result in damage to objects or personal injury.

Close Windows Automatically after Vehicle Locking

You can enable/disable “**Auto window closing when locking**” in the “ →Settings→Vehicle→Doors & Windows” interface in the touchscreen.

warning

When the automatic window locking feature is switched on, the windows will close automatically when the vehicle is locked, make sure that the windows do not jam occupants or obstructions and that there are no occupants in the vehicle, especially children. Then lock.

Fold Side Mirrors automatically after vehicle locking

You can enable/disable “**Auto exterior mirror folding when locking**” in the “ →Mirror Adjustment” interface in the touchscreen.



Anti-theft Alarm System

When the anti-theft system is activated, if any door (including the trunk) or the front hood is opened, the system will alarm using the horn and turn signals. The alarm can be stopped by unlocking the vehicle.

i Tips

The anti-theft system alarm lasts for approximately 28 seconds and is re-timed if the doors (including the boot) or the front compartment lid are opened again.

! warning

Modifications to the vehicle anti-theft system are prohibited, as this may result in the system not functioning correctly.

NFC Card Key

Unlock or Lock the Vehicle



Unlocking: When the vehicle is locked, hold the NFC key against the NFC key sensing area on the driver-side exterior mirror to unlock all doors.

Locking: When all doors (including the front hood and trunk) are closed, hold the NFC key against the NFC key sensing area on the driver-side exterior mirror to lock all doors.



Starting the Vehicle

Within 30 seconds after unlocking the vehicle, get in, depress the brake pedal, and shift gears to start the vehicle. The green READY indicator light will be shown in the touchscreen.

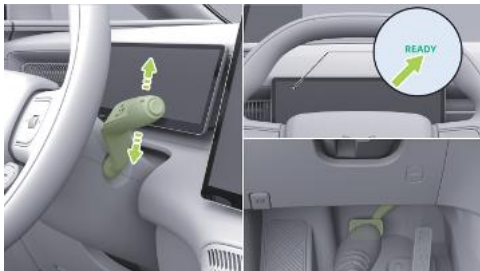

If more than 30 seconds have passed or the touchscreen shows the message **“No key detected”**, place the NFC key in the in-vehicle NFC detection area. After the NFC key is detected, you can depress the brake pedal and shift gears to start the vehicle.

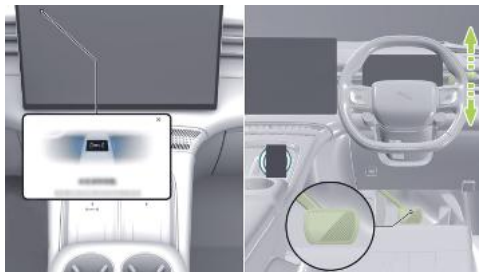

Usage Notes

caution

- Do not bend, twist or cut the NFC card key;
- Do not place the NFC card key in a hot place (e.g. instrument console);
- Do not place mobile phones or other metal objects in the wireless charging area of your phone when you start the vehicle using the NFC card key;



- Do not place the NFC card key in the wireless charging sensing area when using the mobile phone wireless charging feature.

Smart Remote Key

Button Functions

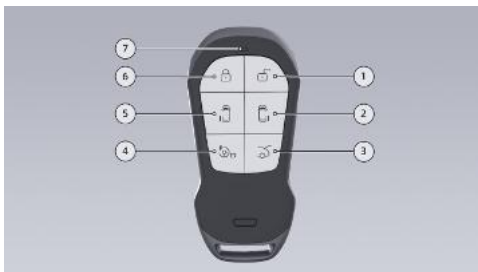

1. Unlock button: Briefly press the unlock button to unlock all doors and the trunk, and disarm the anti-theft system.
2. Right sliding door open/close button: Double-click this button to open/close the

right sliding door. Or pause the right sliding door while it is opening/closing.

3. Trunk button: Double-click the trunk button to automatically open or close the trunk. Or pause the trunk while it is opening/closing.
4. Parking & charge port cover open/close button: Double-click this button to open or close the charge port cover. Or use it in conjunction with parking-related functions.

caution

During parking maneuver operations, the remote key cannot be used for locking/unlocking or opening/closing doors.

5. Left sliding door open/close button: Double-click this button to open/close the left sliding door. Or pause the left sliding door while it is opening/closing.
6. Lock button: Briefly press the lock button to lock all doors and the trunk, and activate the anti-theft system.



7. Indicator light: When any button is pressed, if the key successfully connects to the vehicle, the indicator light flashes once; if the connection is unsuccessful, the indicator light flashes twice.

Tips

- The trunk/charging port cover/sliding door can only be opened with the remote key when the vehicle is in P gear.
- In an open area, the effective range of the remote key is greater than 30 meters. Insufficient battery power will affect the remote control distance. In this case, you can try to get closer to the vehicle or use other methods to operate it.

caution

- The vehicle will not lock unless the vehicle is in P and all doors (including the front compartment lid, the boot) are closed, unless the vehicle is left unattended.

- Keep the key fob safe to prevent damage caused by impact, heat, or corrosion of liquids.
- Do not leave children or pets unattended in the vehicle. Take the key with you when leaving the vehicle and lock the vehicle.

Remote Key Auto Lock&Unlock

In the touchscreen, go to “ **Settings**→**Vehicle**→**Lock/Unlock & Welcome**” to enable or disable “**Auto Lock/Unlock**”. When this function is enabled, the vehicle will automatically unlock when the remote key is carried to within approximately 3.5 meters of the vehicle. When you move approximately 8 meters away from the vehicle, the vehicle will automatically lock.

Tips

- The vehicle is stationary, the doors (including the boot) and the front compartment lid are closed, the vehicle is in P, the vehicle is unmanned. The key is clear of the vehicle for automatic locking, please



make sure the vehicle is locked before leaving.

- Once the vehicle is automatically locked, it may not be possible to sense unlocking the vehicle when approaching the vehicle again if the vehicle is still within the feature sensing range, either by pulling the door handle or manually unlocking using the key.

Replace Key Battery

1. Press the unlock button to remove the decorative cover.



2. Use an appropriate tool (a flat-head screwdriver covered with a soft cloth/tape or a similar tool) to pry up the left edge and move toward the center to loosen the left side of the back cover.



3. Pry up the right edge and move toward the center to loosen the right side of the back cover.



4. Pry up the middle of the back cover and remove it.



5. Rotate the key battery cover plate counterclockwise and remove the key battery cover plate.



6. Remove the key battery. Battery model: CR2450.



7. Install in the reverse order. When installing, make sure the “+” (positive) side of the key battery is facing up.

i Tips

- Wipe the battery surface clean before installation, or finger marks may affect battery life.
- It is recommended that you do not replace the key fob battery yourself, send it to Xpeng Automobile Service Centre for replacement.

! caution

- Dispose of used batteries properly, incorrect disposal of used batteries can damage the environment.
- Do not use sharp objects to remove the key fob, as this may damage the key fob.

! warning

Please keep batteries out of reach of children. If a child accidentally swallows them, it may cause serious injury or even death.

Mobile App Key

Function Overview

After installing the XPENG App, you can register your mobile as a vehicle key. Using Bluetooth and NFC technologies to communicate with the vehicle, this helps you conveniently and safely lock/unlock, start the vehicle, and perform additional vehicle control functions.



The XPENG App supports the following two types of vehicle keys:

1. Mobile Bluetooth key

Applicable devices: Mobile with iOS, HarmonyOS, or Android operating systems.

2. Mobile NFC key

Applicable devices: Mobile with HarmonyOS or Android operating systems that support NFC.

Mobile Bluetooth key

In the XPENG App, tap “**Digital Key**”, then tap the “**Activate**” button for the Bluetooth key and follow the prompts in the XPENG App to create a phone Bluetooth key.

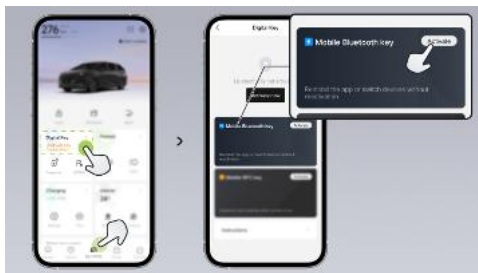

Bluetooth key lock/unlock





After the mobile has been successfully paired with the vehicle via Bluetooth, open the XPENG App to lock/unlock the vehicle, raise or lower the windows, open the trunk, and perform other operations.

Auto Lock/Unlock

After enabling the “**Auto Lock/Unlock**” switch in the XPENG App and successfully pairing the mobile with the vehicle via Bluetooth, carrying the mobile and approaching the vehicle will automatically unlock it; carrying the mobile away from the vehicle will automatically lock it.

i Tips

After unlocking, please do not close the XPeng Motors App. Keep the XPeng Motors App running in the background so that the relative position of the machine and the vehicle can be determined and the automatic unlocking and locking can be performed.

Mobile NFC Key*

Enabling the mobile NFC key

1. Before activating the key, make sure that the “**NFC**” function has been enabled in your mobile operating system.
2. In the XPENG App, go to “**Digital Key**”, tap the “**Activate**” button for the NFC key, and then follow the prompts in the XPENG App to create a mobile NFC key.

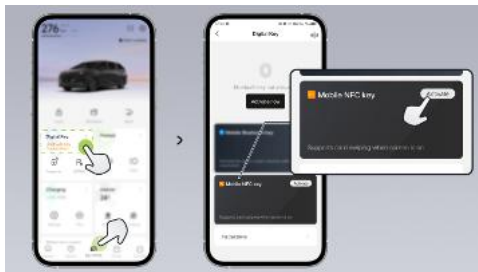

3. After activating the mobile NFC key, to ensure a smooth tapping experience, set the default



payment App on your mobile to the XPENG App (path: Settings → search for “payment App” → select “XPENG App”). If the default payment App is not set to the XPENG App, you will need to manually select the XPENG App as the default payment App before each tap.

i Tips

This feature is only applicable to phones with Android 9.0 or HarmonyOS 2.0 and above operating systems, and with NFC hardware.

Using the mobile NFC key



Unlocking: When the vehicle is locked, wake up the phone screen, then hold the mobile close to the NFC key sensing area on the driver's side exterior rearview mirror for about 1 second to unlock all doors.

Locking: When the vehicle is unlocked and all doors (including the front trunk lid and rear trunk) are closed, wake up the phone screen, then hold the mobile close to the NFC key sensing area on the driver's side exterior rearview mirror for about 1 second to lock all doors.



Starting the vehicle:

- Within 30 seconds after unlocking the vehicle, get in, press the brake pedal, and shift gears to start the vehicle.
- If more than 30 seconds have passed since unlocking the vehicle, or if a “No key detected” message appears in the touchscreen, place your mobile on the wireless charging pad in the vehicle marked with the NFC symbol. After key authentication is complete, you can press the brake pedal and shift gears to start the vehicle.

i Tips

- When unlocking with an Xpeng Auto key, the Xpeng Auto default payment app needs to be set to the Xpeng Auto app, otherwise NFC will not work properly.
- When unlocking/starting the vehicle using the NFC key, the phone screen will need to be unlocked. The phone may be turned off or the screen will not work properly, which may result in the NFC key not being used.

- Keep the back of your phone close to the NFC sensing area as much as possible, depending on the back of your phone.

Unregister Digital Car key

In the touchscreen, go to the “ **Settings**→**General**→**Security and Privacy**” screen, tap “**Unregister digital car keys**”, then in the pop-up dialog box tap “**Confirm and send**”. A verification code will be sent to the vehicle owner’s email. After entering the code and passing verification, all users’ digital vehicle keys will be unregistered.

Frequently Asked Questions

1. Under which conditions (including but not limited to the following) may the automatic lock/unlock function of the Bluetooth key fail?
 - When the mobile battery is low or the mobile is in low-power mode.
 - When Bluetooth is not enabled on the mobile.



- When the phone's operating system has closed the XPENG App.
 - When the Bluetooth signal is unstable and disconnects abnormally.
 - When the Bluetooth signal is blocked by obstacles (such as a backpack, your body, walls, etc.), causing abnormal distance measurement.
 - When the mobile has been restarted or the system has been updated and the XPENG App has not been opened.
 - When you leave the vehicle and Bluetooth disconnects while a door, the front hood, or the trunk is not fully closed.
2. Under which conditions (including but not limited to the following) may the lock/unlock function of the mobile NFC key fail?
- When the mobile battery is low or the mobile is in low-power mode.
 - When NFC is not enabled on the mobile.
 - When the mobile default payment application is not set to the XPENG App.

Tips

If the mobile Bluetooth key cannot lock/unlock the vehicle, first restart the XPENG App. If the issue persists, go to the “**XPENG→Digital Key**” interface and follow the instructions to resolve the connection problem.

Doors

Power Door Handles

When the vehicle is unlocked and the door handle has not automatically presented, you can press and hold the front end of the door handle, then pull the rear end of the door handle to open the door.



Automatic Door Handle Retraction

The door handles will automatically retract when any of the following conditions is met:

- Retraction when locked: When the doors are locked, the door handles will automatically retract.
- Retraction when shifting gears: When shifting from P to N/R/D Gear, the door handles will automatically retract.

- Retraction at higher speed: When the vehicle speed exceeds 3 km/h, the door handles will automatically retract.
- Timeout retraction: After the doors (including the trunk) and front hood are closed, if none of the above retraction operations is triggered within 120 seconds, the door handles will automatically retract.

warning

When using car door handles, be careful to prevent your fingers, jewelry, acrylic nails, etc., from getting caught in the door or door handle mechanism. Otherwise, it may cause damage to property or personal injury.

Tips

- When using the automatic parking feature, the flush door handle remains deployed, pulling the door handle suspends the automatic parking feature.
- Control the door handle fold/show more than 8 times within 1 minute, will trigger the



anti-play mode, the door handle no longer moves, after 20 seconds the function will resume.

Interior Central Lock

You can lock or unlock the doors inside the vehicle by tapping the **Control Center** screen, or by pressing the door lock button. When the doors are locked, the indicator light on the door lock button illuminates amber.

Automatic Unlock when Parked

In the touchscreen, go to “ → **Settings** → **Vehicle** → **Lock/Unlock & Welcome**”, where you can turn “**Automatic Unlock when Parked**” on or off.

Tips

You can also turn Automatic Unlock when Parked on or off using voice commands.

When this function is enabled, the door locks will automatically unlock when the vehicle is shifted to P and the (driver's) seat belt is unbuckled.

Tips

The door locks are also automatically opened/closed if certain conditions are met:

- Drive-in automatic locking: When the doors (including the boot) and the front compartment cover are closed, the door locks automatically lock if the vehicle speed is greater than 10 km/h.
- Automatic door unlock: The door is opened from inside the vehicle (front power release door button/emergency open) and the door lock is automatically unlocked.
- Automatic emergency unlocking: The door locks automatically when the vehicle is involved in a collision or in an emergency such as a thermal loss.



Interior Door Release Button

You can set the interior door opening method in the touchscreen to prevent the doors from being accidentally opened by unintentionally touching the interior door open button when the vehicle is locked.

Setting the Interior Door Opening Method

In the touchscreen, go to “

→**Settings**→**Vehicle**→**Lock/Unlock & Welcome**” to set the interior door opening method to “**Single Press to Open**”/ “**Double Press to Open**”.

- Single Press to Open: In either the unlocked or locked state, pressing the interior door open button once will open the door.



- Double Press to Open: In the unlocked state, pressing the interior door open button once will open the door; in the locked state, pressing the interior door open button twice in succession will open the door.

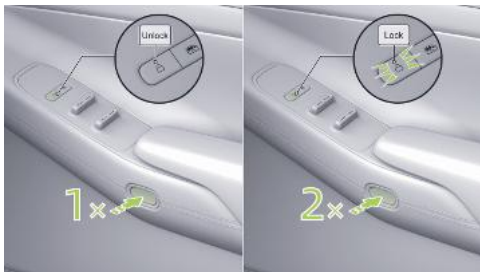

i Tips

- When the vehicle speed is greater than 3 km/h, the door cannot be opened using the interior door button.
- When the door is opened in the unlocked state, the door must be opened by pressing the door button twice in a row after the "Click to Open the Door" switch to "Double Click to Open the Door".

! caution

The vehicle is equipped with a suction lock, which automatically engages when the door is closed to the engaged position until the door is fully closed. Do not reach to prevent the door from closing during door suction to prevent pinching. To terminate the door close, pull the door handle to stop engaging and open the door.

Unlock Door with Mechanical Key

When the vehicle has no power, press the front end of the flush door handle to pull it out, then fully insert the mechanical key into the key cylinder. Turn the key clockwise to unlock the driver's door, then pull the door handle to open the door.



After closing the door, turn it counterclockwise to lock the driver's door.

i Tips

- Only the main door can be opened using the mechanical key, when entering the vehicle, other doors can be opened using the emergency opening handle/ring.
- Make sure the mechanical key is fully inserted before turning the key. When unlocking, the mechanical key needs to be turned back to the home position to be

removed. If the key does not turn during operation, insert the key fully to continue turning.

- In extreme cold weather, do not force the key out if the key does not return when using the mechanical key door. Please contact Xpeng Automobile Service Center.
- The mechanical key is supplied separately with the vehicle, so keep it safe to avoid loss.

Emergency Opening of Front Doors in Power Failure

If the vehicle has no power or in other special situations, you can pull the emergency release handle located below the front door armrest to open the door.

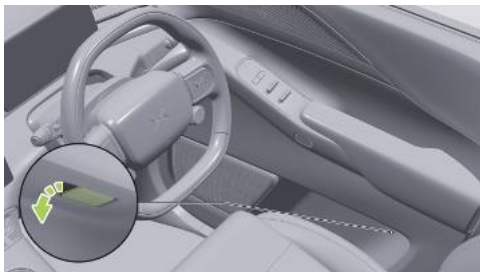

warning

Whether the vehicle is stationary or in motion, the emergency door can be opened by pulling the emergency opening handle once. Except in an emergency, the emergency opening handle should not be pulled while the vehicle is in motion.

Sliding Door

Introduction

You can open/close the sliding door using the following methods:

- Exterior door handle button
- Interior button
- Touchscreen
- Smart Remote Key
- Steering wheel shortcut
- Concealed door handle
- Mobile App
- Voice commands
- Sliding door emergency release handle
- Sliding door emergency lock switch

Tips

- The sliding door has an anti-pinch function. If an obstacle is detected while the door is closing, the sliding door will move back a short distance.



- If the anti-pinch function or the one-touch open/close function fails, you can perform sliding door initialization.

warning

- Please ensure that the sliding doors are fully closed before driving.
- When closing the sliding door, do not place your hands on the edge of the door to avoid injury.
- When closing the sliding door, ensure that there are no people or other obstacles within the door's closing area to prevent injury or vehicle damage.

Open and Close Using the Exterior Door Handle Button



Open

When the vehicle is unlocked, press the arrow-marked position on the exterior handle of the sliding door; the door on that side will open automatically.

Disable

When the sliding door is open, press the arrow-marked position on the exterior handle of the



sliding door; the door on that side will close automatically.

i Tips

When the vehicle is unlocked, press the external switch on the sliding door, and the sliding door will open after the door is unlocked.

Open and Close Using Interior Buttons



Open

When the vehicle is unlocked, press the sliding door open button; the door on that side will open automatically.

Disable

When the sliding door is open, press the sliding door close button; the door on that side will close automatically.

Open and Close Using Touchscreen

In the touchscreen, you can open/close the sliding door using any of the following methods:

- In the touchscreen, tap “☰” to enter the Control Center screen. Tap Left Sliding Door/Right Sliding Door to open/close the sliding door on the corresponding side.
- In the touchscreen, tap “🏠” to enter the Home screen. Tap the sliding door icon below the 3D vehicle model, or tap the hotspot icon in the sliding door area on the 3D vehicle model to open/close the sliding door.



i Tips

The hotspot icons on the 3D vehicle model are hidden by default. You need to tap the 3D vehicle model to display them.

Open and Close Using Smart Remote Key

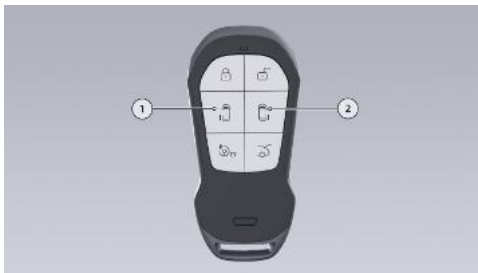

1. Left sliding door open/close button: Double-click this button to open/close the left sliding door. Or pause the left sliding door while it is opening/closing.

2. Right sliding door open/close button: Double-click this button to open/close the right sliding door. Or pause the right sliding door while it is opening/closing.

⚠ warning

- Please operate the sliding door while the vehicle is stationary to avoid opening/closing it after the vehicle has started moving.
- When the car window is lowered and the corresponding sliding door is opened, please do not stick your head or hands out of the window.
- Do not open or close the sliding door on the ramp.

i Tips

- If the vehicle speed exceeds 3 km/h while the sliding door is not fully closed, the instrument panel and an audible alert will warn that the door is not closed.



- When the vehicle speed exceeds 3 km/h, the sliding door can only be closed and cannot be opened.
- When the child lock on the door is activated, the corresponding sliding door cannot be opened using the interior button.
- The sliding door is equipped with an anti-pinch function. When the corresponding window is opened to 20% or more, opening the sliding door will cause the door to slide to a limited position and then stop.
- When the charge port cover is open, opening the right sliding door will cause the door to slide to a limited position and then stop.

Open and Close Using Steering Wheel Shortcut

When the steering wheel shortcut in the touchscreen are set to **“Open/close left sliding door / Open/close right sliding door”**, you can

open/close the sliding door using the steering wheel shortcut.

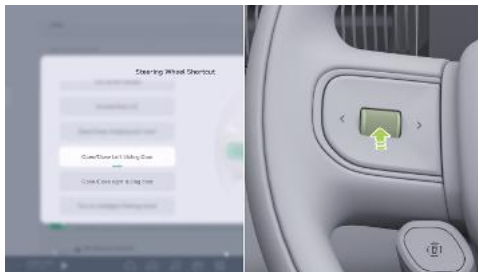

Open and Close Using Concealed Door Handle

Open

When the door is unlocked, first press and hold the rear end of the door handle, then pull the front end of the door handle backward to manually open the sliding door.



Disable

When the sliding door is open, first press and hold the rear end of the door handle, then pull the front end of the door handle backward to release the stop, and you can then manually close the sliding door.

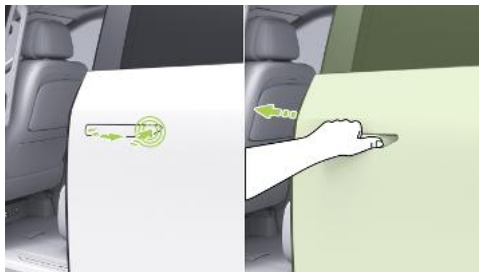

Emergency Locking of Sliding Door

If, under special circumstances, the sliding door cannot be locked, you can lock the door by following these steps:

1. Use an appropriate tool to remove the trim cover on the side of the door, then press the sliding door emergency lock switch.



2. Reinstall the trim cover on the side of the door, then manually close the sliding door until it is fully latched.



i Tips

Close the sliding door; the sliding door is now locked.



Emergency Opening of Sliding Door in Power Failure

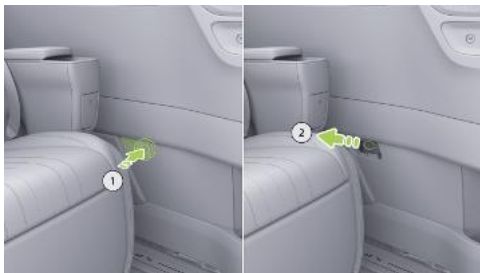

1. Press the front edge of the service cover below the sliding door and remove the service cover.
2. Pull the sliding door emergency release handle and slide the door backward at the same time to open the sliding door in an emergency.

warning

Whether the vehicle is stationary or in motion, pulling the emergency opening ring once will open the door. Except in emergencies, the emergency opening ring should not be pulled while the vehicle is in motion.

Sliding Door Initialization

First press and hold the rear end of the door handle to raise the front end, then pull the front end of the door handle to fully close the door and complete initialization.

Trunk

Trunk Exterior Switch

When the doors are unlocked, press the exterior trunk switch to open/close the trunk, or to pause a trunk that is opening/closing.

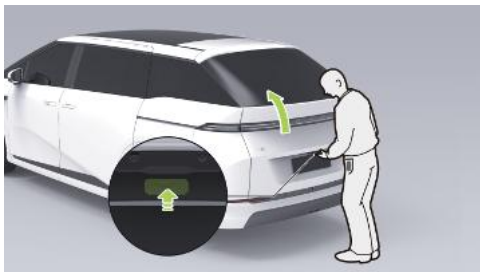

When the vehicle is locked, if you carry the key near the trunk and press the exterior trunk switch, the trunk can be opened.

Trunk Interior Switch

Press the interior trunk switch to close the trunk or to pause a trunk that is opening/closing.





Open&Close Trunk with Remote Key

When the vehicle is in P, double-press the trunk button on the remote key to open/close the trunk. Or pause the trunk while it is opening/closing.



Open&Close Trunk with Touchscreen

In the touchscreen, you can open/close the trunk using any of the following methods:

- In the touchscreen, tap “” to enter the Control Center interface, where you can open/close the “**Trunk**”. Tapping again during movement will pause opening/closing.
- In the touchscreen, tap “” to enter the Home screen, then tap the trunk icon below the 3D vehicle model, or tap the hotspot icon

in the trunk area of the 3D vehicle model to open/close the trunk.

Tips

The hotspot icons on the 3D vehicle model are hidden by default. You need to tap the 3D vehicle model to display them.

Tips

When opening/closing the trunk, if there is an obstacle blocking it, the trunk will retract a certain distance.

warning

When opening or closing the trunk, ensure that there are no people or other obstacles within the opening/closing area to prevent injury or damage to the vehicle.



Open&Close Trunk with Steering Wheel Shortcut

When the steering wheel shortcut in the touchscreen is set to **“Open/Close Trunk”**, you can open/close the trunk using the steering wheel shortcut.



Open&Close Trunk with Mobile App

In the **“XPENG”** screen of the mobile App, you can open/close the trunk.

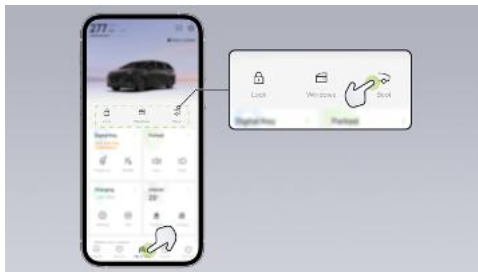

5

i Tips

- You can also open/close the trunk via voice commands.
- When opening/closing the trunk, if there is an obstruction, the trunk will reverse by a certain distance.
- If the trunk is opened/closed frequently within a short period of time, thermal protection will be activated and the trunk opening/closing function will be temporarily disabled. You must wait for the system to



cool down before it can return to normal operation.

warning

When opening/closing the boot, ensure that there are no persons or other obstructions within the open/closed boot area to prevent personal injury or vehicle damage.

Adjust Trunk Opening Angle

The vehicle supports adjusting the trunk opening angle via both the touchscreen and the interior trunk switch.

Adjust the trunk opening angle via the touchscreen.

In the touchscreen, in the “→Settings→Doors & Windows” interface, you can adjust the “Trunk Unfolding Angle Memory”.

Adjust the unfolding angle using the trunk switch

1. After opening the trunk, manually lower or raise it to the desired angle.



2. Press and hold the interior trunk switch until the indicator flashes. The trunk folding angle is then set.



5

i Tips

When the switch is pressed and held, the trunk deployment angle will be set to the lowest value if the trunk deployment angle is below the minimum allowable setting.

Emergency Release Switch

If the trunk cannot be opened, you can open it by following these steps:

1. Fold down the third-row seatbacks and enter the trunk.

2. Open the trim cover on the emergency release mechanism.





3. First push lever ① to the left and hold it, then press lever ② to unlock the trunk, and then push the trunk outward to open it in an emergency.

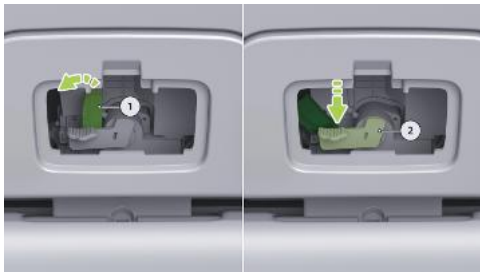

i Tips

After the emergency opening is activated, press down on the trunk to close it.

Trunk Storage

Trunk Storage Compartment

After opening the trunk, you can place luggage and cargo in the trunk storage compartment.



If more storage space is needed, you can fold down the third-row seats to expand the trunk storage compartment.

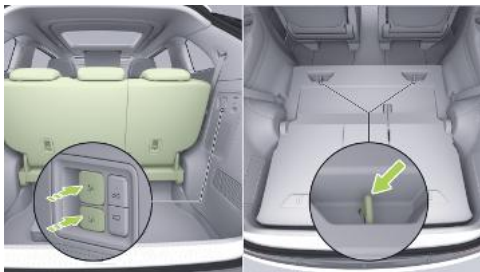

caution

- Do not store fragile, flammable, explosive, etc. in the trunk to avoid fire, explosion, or damage.
- Store liquid items with a tight seal to avoid damage to the vehicle due to fluid leaks. Clean up if leakage occurs.
- Do not drive the vehicle with an overloaded vehicle to avoid excessive braking distances due to excessive inertia, which could result in an accident.

Trunk Hook

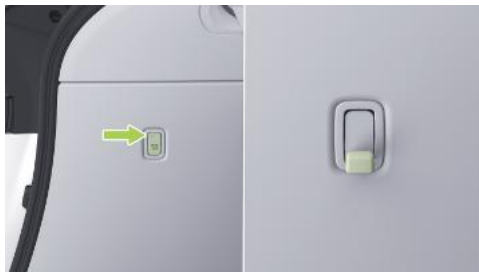

There is a hook on the left side of the trunk. Press the upper part to pop it out when in use; push it back in when not in use.

caution

Do not hang items weighing more than 3 kg to avoid damaging the hooks.



Trunk Floor Tie-Downs

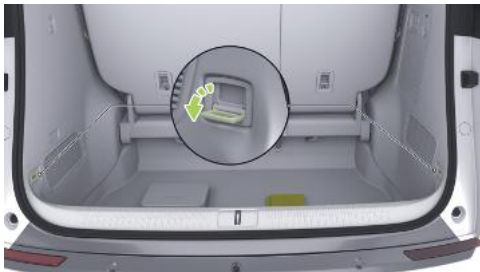

Flip out the trunk floor tie-downs to secure loose items.

caution

- When not in use, always return the floor tie-downs to the stowed position to prevent damage.
- Do not hang items weighing more than 5 kg on the floor tie-downs to avoid damage.

Trunk Cargo Net Tie-Downs

Before installing the trunk cargo net, fold down the third-row seats to expose the third-row seat tie-downs.

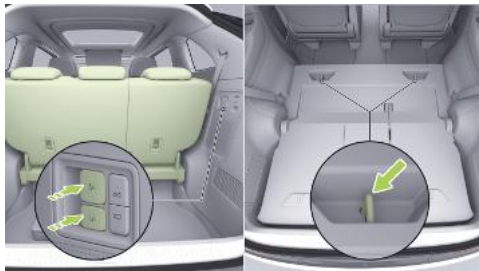

Attach the net hooks to the third-row seat tie-downs and the trunk tie-downs to secure loose items.

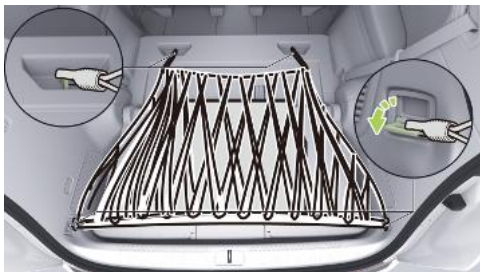

caution

- When not in use, always return the floor tie-downs to the stowed position to prevent damage.
- Do not hang items weighing more than 5 kg on the floor tie-downs to avoid damage.

Reminder for Passengers Left in Rear Seats

Function Overview

The Rear Seat Reminder function detects the status of the rear seats, seat belts, and other information to provide a reminder of rear occupant presence.

caution

This function cannot be guaranteed to be completely accurate. Please check the rear area carefully when leaving the vehicle and never leave children, people in need of assistance, or pets alone in the vehicle.

Touchscreen Settings

In the touchscreen, go to “ → **General** → **Safety and Privacy**” to enable or disable the Rear Seat Reminder function. When it is enabled, if rear activity information is detected, the driver will be



reminded to check the rear seats when exiting the vehicle.

Standby Mode

Function Overview

When the vehicle is in Park (P), you can enter Standby Mode in the touchscreen under “ →**Vehicle**→**Display**”. After entering Standby Mode, the exterior lights and screens will turn off.

Shifting gears, tapping the touchscreen, waking the voice assistant XPENG, turning on the rear entertainment screen, or opening a door will automatically exit Standby Mode.

Tips

You can also enter Standby Mode via voice commands.

Child Left Reminder

Introduction



The Child Left Reminder function uses sensors located behind the interior rearview mirror and above the second-row ceiling to detect whether a child has been left in the vehicle. If the relevant conditions are met, the system will remind the driver in multiple ways and automatically turn on the vehicle's air conditioner to help prevent the risks of suffocation and heatstroke that can



occur if a child is left in the vehicle for an extended period.

The Child Left Reminder function is activated only when all of the following conditions are met:

- The Child Left Reminder function switch is turned on.

The vehicle is in P gear.

The vehicle is locked.

Temporary Parking Mode, Pet Mode, and Meditation Mode are not activated.

There are no faults in the system components.

caution

This feature cannot be guaranteed to be completely accurate, look carefully at the rear of the vehicle when leaving it and never leave children, people in need of assistance or pets alone in the vehicle.

Operation

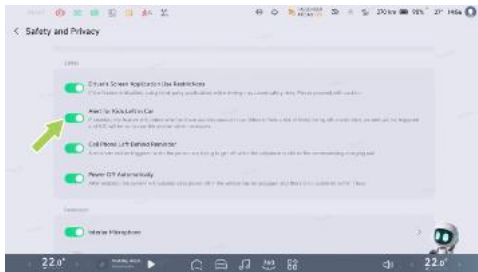

On the Touchscreen, in the “ → **General** → **Safety and Privacy**” screen, you can enable or disable the Child Left Reminder function.

Tips

When turning off the child legacy alert feature, you need to confirm it twice in the pop-up window.



Child Left Reminder Alert

When the operating conditions are met and the system detects that a child has been left in the vehicle, it will alert you in the following ways:

- The hazard warning lights flash.



- Reminder messages are displayed on the vehicle's Touchscreen.
- A reminder is sent via the XPENG App.

i Tips

The alarm lasts longer than 5 minutes and the system automatically switches on the air conditioning if the vehicle temperature is greater than 30°C and the range is greater than or equal to 25km.

Canceling the Alert

While the vehicle is issuing an alert, opening any door will cancel the alert, or it will automatically cancel after the alert has been active for approximately 25 minutes.

Warnings, Limitations, and Notes

In the following situations, the system may be affected or may not operate:

- The sensor area is covered by other objects.
- There are objects in the cockpit that strongly reflect electromagnetic waves, such as large metal items.
- The detected target is located outside the detection area, such as in the trunk.



In the following situations, the system may be triggered falsely:

- When locking the vehicle, there is a powered toy with moving functions operating in the vehicle.
- When locking the vehicle, there are pendants or other objects swinging in the vehicle.

Pet Mode

Introduction

After Pet Mode is enabled, when the driver leaves the vehicle, it helps ensure the safety of pets left alone inside and displays information about the in-vehicle safety status. If there are children in the vehicle, make sure they are accompanied by an adult.

Set via Touchscreen

Enabling Pet Mode

Enable Pet Mode by following these steps:

1. Make sure the vehicle is in Park (P) and the remaining battery charge is greater than 20% before enabling Pet Mode.
2. In the touchscreen, go to “ → **Settings** → **Vehicle** → **Maintenance** → **Pet Mode**” to enter the Pet Mode screen.
3. On the Pet Mode screen of the touchscreen, tap the “**Start immediately**” button to enable Pet Mode. After Pet Mode is enabled, the air conditioner automatically switches to AUTO mode. You can manually adjust the air conditioner temperature to keep the interior temperature comfortable. All four windows will close automatically, and the window lock and child lock will lock automatically. Do not forget to lock the vehicle. After the vehicle is locked, the air conditioner and the touchscreen will remain on.



4. After the driver leaves the vehicle, the touchscreen will show the current interior temperature to inform nearby passersby that rescue is not required.

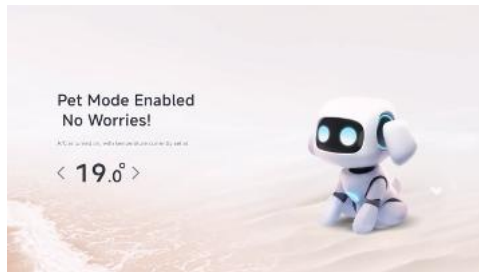

i Tips

When the vehicle charge falls below 5% or the vehicle functions erratically (for example: Abnormal air conditioning), the windows open 10% to allow air to flow inside the vehicle.

Exit Pet Mode

When the driver returns, tap and hold the “Exit” button on the Pet Mode screen of the touchscreen to exit Pet Mode.

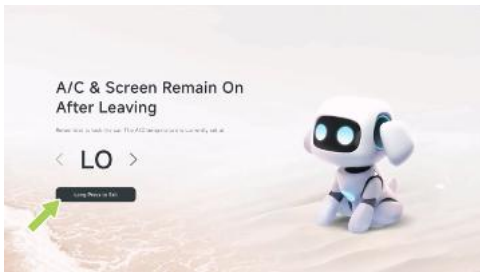

Set via the Mobile App

Enabling Pet Mode

Enable Pet Mode by following these steps:

1. Make sure the vehicle is in Park (P) and the remaining battery charge is greater than 20% before enabling Pet Mode.
2. In the mobile App, tap “**XPENG**→**Intelligent Air Conditioner**→**Pet Mode**”, then confirm in the pop-up window to enable Pet Mode.



3. After Pet Mode is enabled, the air conditioner automatically switches to AUTO mode. You can manually adjust the air conditioner temperature in the mobile App to keep the interior temperature comfortable. All four windows will close automatically, and the window lock and child lock will lock automatically. Do not forget to lock the vehicle. After the vehicle is locked, the air conditioner and the touchscreen will remain on.



After the driver and passengers leave the vehicle, the touchscreen will show the current interior temperature to inform people nearby that no rescue is required.

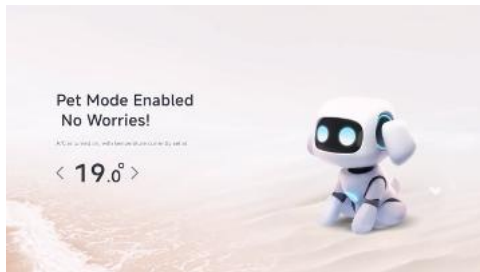

Exit Pet Mode

After the driver or passengers return, tap “XPENG→Intelligent Air Conditioner→Pet Mode” in the mobile App, then confirm in the pop-up window to exit Pet Mode.



Camping Mode

Introduction

When you are on an outing or in similar situations, you can enable Camping Mode. After it is enabled, the Power Off Automatically and automatic lock/unlock functions will be temporarily disabled to provide a more comfortable and convenient outdoor vehicle experience.



Operation

When the conditions for enabling Camping Mode are met, you can enable Camping Mode using any of the following methods:

- Use a voice command directly (for example, say “Hi, XPENG, turn on Camping Mode”).
- In the touchscreen, tap the “**Combo Mode**” screen, then select Camping Mode to turn it on or off.

Before enabling Camping Mode, make sure the vehicle meets the following conditions:

- The gear position is in P.
- Remaining driving range is above 10%.
- Pet Mode and P-Comfort Mode are not enabled.
- The vehicle is not in a system update state.

Exit Camping Mode

After Camping Mode is enabled, you can exit Camping Mode using any of the following

methods. After exiting, Power Off Automatically and automatic lock/unlock will be restored:

- Use a voice command directly (for example, say “Hi, XPENG, exit Camping Mode”).
- In the touchscreen, tap “**Combo Mode**→**Camping Mode**” to open the pop-up window, then tap “**Exit**”.
- Tap “**Camping Mode**” in the upper-left corner of the touchscreen to open the pop-up window, then tap “Exit.”

Camping Mode will exit automatically when any of the following conditions is met:

- Remaining driving range is below 10%.
- The gear position is shifted out of P.
- The vehicle is powered off in an emergency via the touchscreen.
- The vehicle is powered off in an emergency via the SOS switch.
- The vehicle is locked using the mobile App or the NFC key.



X-Park

Introduction

When you need to leave the vehicle temporarily, you can enable X-Park Mode. After it is enabled, once the vehicle is locked, the system will continue to maintain a comfortable interior environment and will not Power Off Automatically.

Operation

You can enable X-Park Mode using any of the following methods:

- In the touchscreen, tap the “**Combo Mode**” screen, then select X-Park Mode to turn it on or off.
- In the XPENG App, tap “**XPENG→X-Park Mode**”, then confirm in the pop-up window to enable X-Park Mode.



i Tips

In the pop-up window of the XPENG App, you can select “**Lock vehicle at the same time**”. After selecting it, the vehicle will automatically lock when X-Park Mode is activated.

Before enabling X-Park Mode, make sure the vehicle meets the following conditions:

- The vehicle is powered on.
- The gear position is in P.



- Remaining driving range is above 10%.
- Pet Mode and Camping Mode are not enabled.

Exit X-Park Mode

After X-Park Mode is enabled, you can exit X-Park Mode using any of the following methods:

- In the touchscreen, tap “**Combo Mode→X-Park Mode**”, then confirm in the pop-up window to exit X-Park Mode.
- Tap “**X-Park Mode**” in the status bar of the touchscreen, then confirm in the pop-up window to exit P-Comfort Mode.
- In the XPENG App, tap “**XPENG→P-Comfort Mode**”, then confirm in the pop-up window to exit P-Comfort Mode.
- In the XPENG App, tap “**XPENG→Exit**”, then confirm in the pop-up window to exit X-Park Mode.

P-Comfort Mode will exit automatically when any of the following conditions is met:

- Remaining driving range is below 5%.

- The gear position is shifted out of P.
- The vehicle is powered off in an emergency via the touchscreen.
- The vehicle is powered off in an emergency via the SOS switch.

Tips

- After P-Comfort Mode has been running for 1 hour, the system will send a notification to the XPENG App indicating that it has been running for 1 hour.
- When locking the vehicle from outside, if the vehicle detects that a passenger remains inside, the system will temporarily activate X-Park Mode. The vehicle will remain powered on for 5 minutes, and a pop-up notification will appear on the touchscreen while a message is also sent to the XPENG App. At this time, you can tap Confirm on the touchscreen pop-up or use the XPENG App to keep P-Comfort Mode running. If X-Park Mode is not activated on the touchscreen



or in the XPENG App within 5 minutes, the vehicle will power off automatically.

caution

- The X-Park Mode is intended only to maintain a comfortable in-vehicle environment during temporary absence from the vehicle. Do not leave children or pets alone in the vehicle.
- After X-Park Mode is activated, it must be turned off manually via the touchscreen or the XPENG App. If you will be away from the vehicle for an extended period, it is recommended to turn off X-Park Mode to avoid excessive range consumption caused by prolonged operation.



Air Conditioner

Page Display

Front air conditioner screen in the touchscreen

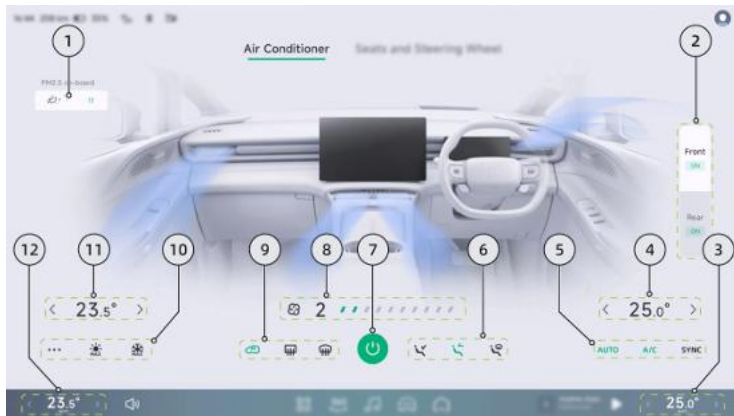

6

1. PM2.5 purification

7. Turn front air conditioner on/off



2. Front/rear air conditioner switch	8. Air volume adjustment
3. Driver air conditioner module	9. Heating and defrost/internal and external circulation
4. Adjust driver temperature	10. Rapid temperature control/Intelligent air conditioner
5. Air conditioner mode	11. Adjust front passenger temperature
6. Airflow mode	12. Front passenger air conditioner module



Rear air conditioner screen in the touchscreen



6

1. Front/rear air conditioner switch	6. Adjust third-row temperature
2. Adjust second-row left temperature	7. Automatic air conditioner mode

Interior Functions



3. Adjust second-row right temperature	8. Airflow mode: Foot mode
4. Adjust air volume	9. Airflow mode: Face mode
5. Turn rear air conditioner on/off	10. Gentle Breeze



Rear air conditioner control panel

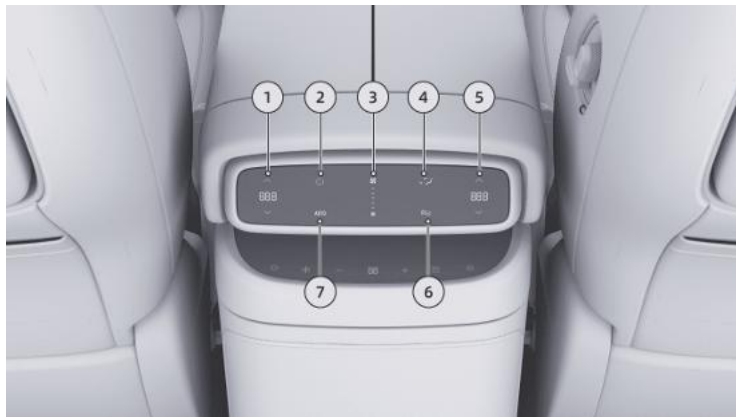

6

1. Adjust second-row left temperature	5. Adjust second-row right temperature
2. Turn rear air conditioner on/off	6. Gentle Breeze



3. Adjust air volume	7. Automatic air conditioner mode
4. Airflow mode	

Turn Air Conditioner On&Off

You can turn the air conditioner on or off using the touchscreen, the rear air conditioner control panel, the steering wheel buttons, the mobile App, or voice commands.

Turning the air conditioner on/off via the touchscreen



You can access the air conditioner screen in the touchscreen using any of the following methods:

- Use voice commands to enter the air conditioner screen, for example by saying keywords such as “Open the air conditioner screen.”
- Tap the air conditioner module on the bottom taskbar of the touchscreen to enter the air conditioner screen.

i Tips

Before using the air conditioner module, make sure it has been added to the taskbar at the bottom of the touchscreen.

In the touchscreen, you can turn the air conditioner on or off using any of the following methods:

- On the air conditioner screen of the touchscreen, tap “” to turn the front air conditioner on or off.
- On the rear air conditioner screen of the touchscreen, tap “” to turn the rear air conditioner on or off.



Turning the air conditioner on/off via the rear air conditioner control panel

On the rear air conditioner control panel, tap “” to turn the rear air conditioner on or off.



i Tips

- When the vehicle powers off, the system will automatically store the air conditioner status. If the air conditioner was on before power off, it will automatically return to the ON status when the vehicle is powered on again.

- When the air conditioner is off, adjusting the blower level, temperature, or similar settings will automatically turn the air conditioner on.
- If the front air conditioner is off and the rear air conditioner is turned on via the rear air conditioner control panel, the front air conditioner will turn on at the same time.

Quickly turn off the air conditioner using the steering wheel button

When the air conditioner is on, set the air volume to level 1, then press the left button on the left side of the steering wheel twice in succession to quickly turn off the air conditioner.

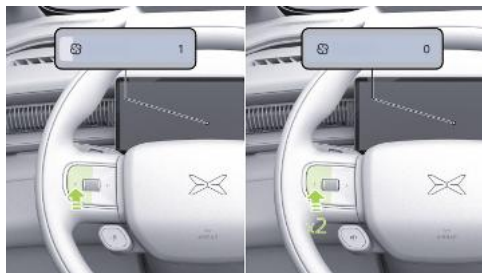

Turn the air conditioner on/off via the mobile App

In the mobile App, tap “XPENG→Intelligent Air Conditioner→” to turn the air conditioner on/off.



A&C Button (Cooling&Heating Button)

The vehicle is equipped with an electric compressor. When you turn on the A/C button in the touchscreen, the compressor starts operating. Based on the currently set air conditioner temperature, the system will provide cooling or heating. When the set temperature is lower than the in-vehicle temperature, the vehicle will cool the cabin. When the set temperature is higher than the in-vehicle temperature, the vehicle will heat the cabin.



When the A/C button is turned off, the compressor stops operating. The air conditioner will then only blow unconditioned air, with no cooling or heating function.

You can turn the A/C on/off using any of the following methods:

- Turn the A/C on/off via voice commands.
- On the air conditioner screen, tap “**A/C**” to turn the A/C on/off.

Air Conditioner Auto Mode (AUTO)

When the air conditioner is in automatic mode, you can manually adjust the temperature. The system will automatically control the air volume, internal and external circulation, and other settings based on the set air conditioner temperature. For daily use, it is recommended to use the air conditioner automatic mode.

You can turn air conditioner automatic mode on/off via the touchscreen, the rear air conditioner control panel, or voice commands.

Turn air conditioner automatic mode on/off via the touchscreen

In the touchscreen, you can turn air conditioner automatic mode on/off using any of the following methods:

- On the front air conditioner screen of the touchscreen, tap “**AUTO**” to turn front air conditioner automatic mode on/off.
- On the rear air conditioner screen of the touchscreen, tap “**AUTO**” to turn rear air conditioner automatic mode on/off.

Turn air conditioner automatic mode on/off via the rear air conditioner control panel

On the rear air conditioner control panel, tap “**AUTO**” to turn rear air conditioner automatic mode on/off.



i Tips

When the air conditioner is in AUTO mode, manually adjusting the airflow, turning off the A/C button, enabling Breeze Mode, or changing the airflow mode will automatically exit AUTO mode.

Adjust Air Conditioner Temperature

You can adjust the air conditioner temperature via the touchscreen, the rear air conditioner control panel, the steering wheel scroll wheel, the mobile App, or voice commands.

Adjust the air conditioner temperature via the touchscreen

Adjust the air conditioner temperature on the front air conditioner screen or in the bottom status bar of the touchscreen:

- Tap < or > to adjust the driver/front passenger air conditioner temperature step by step.
- Swipe left or right to quickly adjust the driver/front passenger air conditioner temperature.

Adjust the air conditioner temperature on the rear air conditioner screen of the touchscreen:

- Tap < or > to adjust the second-row left, second-row right, or third-row air conditioner temperature step by step.
- Swipe left or right to quickly adjust the second-row left, second-row right, or third-row air conditioner temperature.



Adjust the air conditioner temperature via the rear air conditioner control panel

Tap \wedge or \vee to adjust the second-row air conditioner temperature step by step. Press and hold to continuously adjust the second-row air conditioner temperature.



Adjust the air conditioner temperature via the steering wheel scroll wheel

When both LCC and NGP functions are off, you can use the scroll wheel on the left side of

the steering wheel to adjust the air conditioner temperature.

- Push the scroll wheel on the left side of the steering wheel upward to increase the air conditioner temperature.
- Push the scroll wheel on the left side of the steering wheel downward to decrease the air conditioner temperature.





Adjust the air conditioner temperature via the mobile App

In the mobile App, tap “XPENG→Cabin Temperature” and swipe left or right in the temperature display area to quickly adjust the air conditioner temperature.



Zoned air conditioner temperature control

Tap ^ or v in the driver air conditioner control area, then tap “Sync” in the pop-up window to turn temperature synchronization mode on/off. When enabled, the front passenger and rear

temperatures will be adjusted in sync with the driver temperature.

Adjust Air Conditioner Fan Speed

You can adjust the air volume via the touchscreen, the rear air conditioner control panel, the steering wheel buttons, or voice commands.



Adjust the air volume via the touchscreen

You can adjust the air volume in the touchscreen as follows:

- On the front air conditioner screen, tap or swipe left or right on the volume level display to adjust the front air volume.
- On the rear air conditioner screen of the touchscreen, tap or swipe left or right on the volume level display to adjust the rear air volume.



Adjust the air volume via the rear air conditioner control panel

On the rear air conditioner control panel, tap or press and hold  / , or slide the airflow bar up or down to adjust the rear air volume.



Adjust air volume using steering wheel buttons

When both LCC and NGP functions are turned off, you can use the left and right buttons on the steering wheel to adjust the air volume.

- Press the left button on the steering wheel to decrease the air volume.

- Press the right button on the steering wheel to increase the air volume.





Adjust Air Conditioner Airflow Mode

The vehicle supports the following three airflow modes. Multiple airflow modes can be activated at the same time, but at least one airflow mode must remain on:

-  **Front defrost mode:** The air conditioner airflow is directed toward the windows. Defrost mode is recommended when you need to remove frost or fog from the glass.



-  **Face mode:** The air conditioner airflow is directed toward your face. Face mode is recommended when cooling in summer.
-  **Foot mode:** The air conditioner airflow is directed toward your feet. Foot mode is recommended when heating in winter.

You can adjust the air conditioner airflow mode via the touchscreen, the rear air conditioner control panel, or voice commands.

Adjust the front air conditioner airflow mode via the touchscreen.



On the front air conditioner screen, you can set the front airflow mode.

Adjust the rear air conditioner airflow mode via the touchscreen

On the rear air conditioner screen of the touchscreen, you can set the rear airflow mode.

Adjust the rear air conditioner airflow mode via the rear air conditioner control panel

You can also tap  on the rear air conditioner control panel to set the rear airflow mode.

- : Face mode.
- : Foot mode.
- : Face/Foot mode.





Adjust Air Conditioner Air Vent Mode

The front face-level air vents can be adjusted via the air conditioner screen in the touchscreen and by voice commands, while the second-row face-level air vents can be adjusted manually.

Adjust the front air conditioner vent airflow pattern via the touchscreen

When the airflow mode is set to Face or Face+Foot mode, you can tap the airflow animation on the air conditioner screen to enter the vent airflow pattern adjustment screen.

- Open/close vents: Tap a vent to open or close the corresponding vent, but at least one vent must remain open.
- Adjust vent direction: Slide the airflow animation up or down to adjust the vertical airflow angle, and slide it left or right to adjust the horizontal airflow angle.

Intelligent adjustment of the front air conditioner vent airflow pattern

- Avoid driver/passenger: The vent airflow direction will avoid the core chest area of the driver and front passenger.
- Horizontal sweep: The vents will sweep left and right according to the setting. You can slide the airflow animation up or down to adjust the vertical airflow angle during this mode.

caution

During automatic adjustment of the vents, make sure there are no foreign objects inside the outlets (such as children's fingers), otherwise personal injury or vehicle damage may occur.

Adjust the second-row face-level air vents

Move the vent left or right to adjust the airflow direction, move it up or down to adjust the airflow volume, and push it fully upward to close the vent.





caution

Do not throw objects into the vents, as this may cause damage to the vehicle.

Air Conditioner Internal&External Circulation

The air circulation function includes two modes: internal circulation and external circulation. You can switch between them in any of the following ways:

- Switch the air circulation mode by voice command, for example by saying key phrases such as “switch to internal circulation” or “switch to external circulation.”
- On the air conditioner screen, tap  to switch the air circulation mode.

 **Internal Circulation:** When the outside air quality is poor, it is recommended to select internal circulation. The system prevents dust and harmful gases from entering the vehicle and improves in-cabin air quality.

 **External Circulation:** When the outside air quality is good, you can select external circulation mode. The system will draw fresh air from outside into the vehicle to improve in-cabin air quality.

Air Conditioner Defrost&Defog



You can turn the front and rear defrost/defog functions on or off via the touchscreen, the mobile App, or voice commands.





 **Front defrost/defog:** When activated, it can quickly remove fog from the windshield and front door windows.

 **Rear defrost/defog:** When activated, it can quickly remove fog from the rear window and the exterior rearview mirrors.

Turn defrost/defog on or off via the touchscreen

On the air conditioner screen, tap  or  to turn the defrost/defog function on or off.

Turn defrost/defog on or off via the mobile App

In the mobile App, tap “XPENG→Intelligent Air Conditioner→” or “” to turn the defrost/defog function on or off.



Tips

- When the front defrost/defog function is turned on, the vent mode will automatically switch to the front defrost mode. When the vent mode is switched to face or foot mode, the front defrost/defog function will automatically turn off.
- When the front defrost/defog function is turned on, the system will simultaneously activate the front windshield heating function, which will automatically turn off after operating for a period of time.



- The rear defrost/defog function and the side mirror heating function share the same switch and turn on and off together. This function will automatically turn off after it has been on for a period of time.

caution

Do not place anything on the instrument panel, as this may obscure the air vents and obstruct the air conditioning air flow, which may affect the defrost and demist effect of the front window glass.

warning

- When the side mirror heating function is on, do not touch the mirror surfaces.
- When the windshield heating function is on, do not touch the wiper area at the bottom of the windshield.

Max Heating Mode

You can turn Max Heating mode on or off via the touchscreen, the mobile App, or voice commands.

After Max Heating mode is turned on, the air conditioner will automatically be set to the highest temperature, and the seat heating and steering wheel heating functions will be turned on at the same time.

Turning Max Heating mode on/off via the touchscreen

On the air conditioner screen, tap  to turn Max Heating mode on or off.

Turning Max Heating mode on/off via the mobile App

In the mobile App, go to the “XPENG” page or “XPENG→Intelligent Air Conditioner” to enter the air conditioner settings page, then tap “” to turn Max Heating mode on or off.



Max Cooling Mode

You can turn Max Cooling mode on or off via the touchscreen, the mobile App, or voice commands.

After Max Cooling mode is turned on, the air conditioner will automatically be set to the lowest temperature and maximum fan speed, and the seat ventilation function will be turned on at the same time.

Turning Max Cooling mode on/off via the touchscreen

On the air conditioner screen, tap  to turn Max Cooling mode on or off.

Turning Max Cooling mode on/off via the mobile App

In the mobile App, go to the “XPENG” page or “XPENG→Intelligent Air Conditioner” to enter the air conditioner settings page, then tap “” to turn Max Cooling mode on or off.





Gentle Breeze

The rear air conditioner supports Gentle Breeze mode. After Gentle Breeze is turned on, the rear air conditioner will automatically switch to face-level mode, the airflow will enter automatic adjustment, and the temperatures of the second and third rows will be synchronized.

You can turn Gentle Breeze on or off via the touchscreen, the rear air conditioner control panel, or voice commands.

Turning Gentle Breeze on/off via the touchscreen

On the rear air conditioner screen of the touchscreen, tap  to turn Gentle Breeze on or off.

Turning Gentle Breeze on/off via the rear air conditioner control panel

On the rear air conditioner control panel, tap  to turn Gentle Breeze on or off.



Tips

After the Gentle Breeze mode is activated, if the rear airflow level or rear airflow mode is adjusted manually, or if the rear A/C AUTO mode is turned on, Gentle Breeze mode will turn off automatically.

Remove Air Conditioner Odor

If the air conditioner filter has not been replaced for a long time, if bacteria are present in the air conditioner ducts, or if items that emit special gases are stored in the vehicle, you may



notice an unusual odor after turning on the air conditioner. You can use the following methods to eliminate or reduce odors inside the vehicle.

Reducing particulate concentration via XFREEBREATH in the touchscreen

When the outside air quality is poor (PM2.5 readings are high) or there is a high concentration of inhalable particles inside the vehicle (such as after smoking), it is recommended to turn on the XFREEBREATH function. The system continuously monitors and displays changes in PM2.5 levels. When the in-vehicle air quality is poor, the system will proactively remind you to turn on the XFREEBREATH function. The system uses a high-efficiency filter to remove airborne particles and help ensure in-vehicle air quality.

On the air conditioner screen, tap “” to turn on the XFREEBREATH function.

Quickly removing odors via REFRESH in the touchscreen

After the REFRESH function is turned on, on the air conditioner screen, the system will switch to fresh-air mode and set the fan speed to the maximum. The windows will lower to a ventilation position, and rapid ventilation will be used to remove odors from the vehicle interior.

On the air conditioner screen, tap “**Smart→REFRESH**” to turn the REFRESH function on or off. After the REFRESH function is turned on, it will run automatically for 180 seconds and then turn off. After the function is turned off, the windows will not return to their original position automatically. To prevent injury from entrapment, adjust the windows as needed.

Preventing outside exhaust from entering the vehicle via the Exhaust Intake Mitigation function in the touchscreen

After the Exhaust Intake Mitigation function is turned on on the air conditioner screen, if the vehicle detects exhaust pollution outside, it will



automatically switch to recirculation mode to help ensure in-vehicle air quality.

On the air conditioner screen, tap **“Smart→Exhaust Protection”** to turn the Exhaust Intake Mitigation function on or off.

i Tips

- After the Exhaust Intake Mitigation function is turned on, if the Refresh function is manually activated, the Exhaust Protection function will automatically turn off. Once the Refresh function is turned off, the Exhaust Intake Mitigation function will return to the on state.
- If the air conditioner filter element is not replaced for a long time, the vehicle may continuously emit unpleasant odors. Please go to an XPENG service center to replace the air conditioner filter element when the vehicle has been driven for one year or 20,000 km, whichever comes first.

Reduce Air Conditioner Energy Consumption

When the air conditioner is turned on, it will continuously consume power from the battery. You can reduce air conditioner energy consumption in the following ways.

Turning on A/C Energy-Saving mode via the touchscreen

After A/C Energy-Saving mode is turned on, the cooling and heating performance of the vehicle will be slightly reduced, which lowers energy consumption and extends driving range. When traveling alone, it is recommended to turn on Eco Mode.

On the air conditioner screen, tap **“Smart→ECO Mode”** to turn ECO Mode on or off.

Turn on Auto Vent Control Mode via the touchscreen

After Auto Vent Control Mode is turned on, the rear air conditioner will automatically turn



on or off depending on whether the rear seats are occupied, reducing air conditioner power consumption and extending driving range.

On the air conditioner screen, tap “**Smart→Auto Vent Control**” to turn the Auto Vent Control function on or off.

Driver's Seat

Adjust Driver Seat Position

You can adjust the driver's seat to a suitable position using any of the following methods:

- Adjust the seat position using the seat switch.
- Adjust the seat position using the touchscreen.
- Adjust the seat position using voice commands.

Adjusting the fore-aft position using the seat switch

Move this adjustment switch forward or backward to adjust the fore-aft position of the driver's seat.

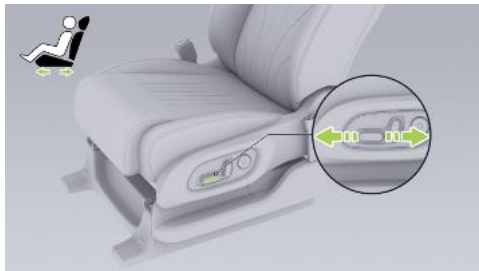

Adjusting the seat height with the seat switch

Push the rear of this adjustment switch up or down to adjust the height of the driver's seat.

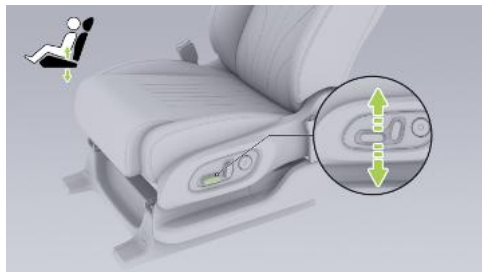



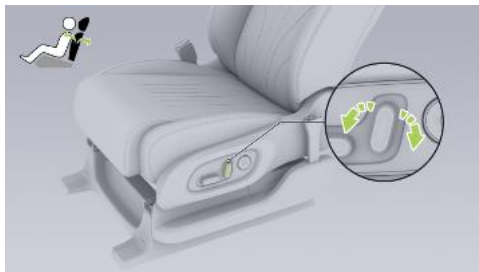

Adjusting the seatback angle with the seat switch

Move the top of this adjustment switch forward or backward to adjust the recline angle of the driver's seatback.



Adjust the seat position via the touchscreen

In the touchscreen, tap in sequence “ →  → **Seat Position** → Select “**Driver's Seat**” → **Seat Adjustment**” to enter the driver's seat adjustment screen, then select “**Seat**”.

- Height: Tap  or  to adjust the seat height step by step. Press and hold to continuously adjust the seat height. You can also tap or slide the slider to quickly adjust the seat height.



- **Position:** Tap < or > to adjust the seat fore-aft position step by step. Press and hold to continuously adjust the seat fore-aft position. You can also tap or drag the slider to quickly adjust the seat fore-aft position.
- **Angle:** Tap < or ∨ to adjust the seatback angle step by step. Press and hold to continuously adjust the seatback angle. You can also tap or drag the slider to quickly adjust the seatback angle.

warning

Adjusting the driver's seat while the vehicle is in motion is prohibited, as it may cause the vehicle to lose control and lead to an accident.

Adjust Driver Seat Cushion Height

You can adjust the driver's seat cushion to a suitable position using any of the following methods:

- Adjust the seat cushion using the seat switch.
- Adjust the seat cushion using the touchscreen.

- Adjust the seat cushion using voice commands.

Adjusting seat cushion height with the seat switch

Push the front of this adjustment switch up or down to adjust the height of the driver's seat cushion.

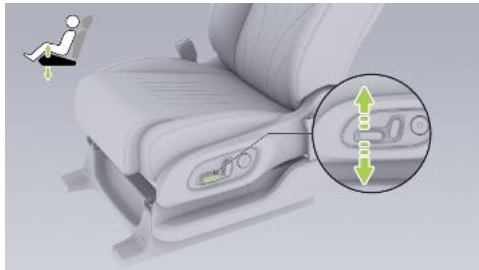

Adjusting the seat cushion height via the touchscreen

In the touchscreen, tap “ →  → **Seat Position** → **Select “Driver Seat”** → **Position**



Adjustment to enter the driver seat adjustment screen, then select **"Cushion"**.

Tap \triangleright or \triangleleft to adjust the seat cushion height step by step. Press and hold to continuously adjust the seat cushion height. You can also tap or drag the slider to quickly adjust the seat cushion height.

Adjust Driver Seat Lumbar Support

You can adjust the driver's seat lumbar support using any of the following methods:

- Adjust the seat lumbar support using the seat switch.
- Adjust the seat lumbar support using the touchscreen.
- Adjust the seat lumbar support using voice commands.

Adjusting the seat lumbar support with the seat switch

- Press the Up/Down button to adjust the raised height of the lumbar support.

- Press the Left/Right button to adjust the raised position of the lumbar support.

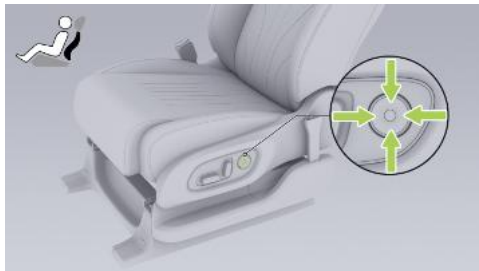

Adjusting the seat lumbar support with the touchscreen

In the touchscreen, tap $\text{☰} \rightarrow \text{🪑}$
 \rightarrow Seat Position \rightarrow Select **"Driver Seat"** \rightarrow Position Adjustment to enter the driver seat adjustment screen, then select **"Lumbar Support"**.

- Height: Tap \wedge or \vee to adjust the raised height of the driver's seat lumbar support.



- Position: Tap < or > to adjust the raised position of the driver's seat lumbar support.

Driver Seat Headrest

Adjusting head headrest height

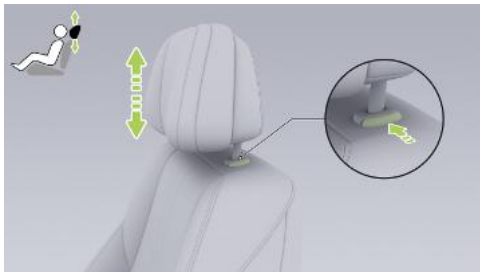

- Adjustment upward: Lift the headrest upward to a suitable position, then press it downward to make sure it is locked in place.
- Adjustment downward: Press and hold the headrest adjustment button, move the headrest downward to a suitable position, then

release the button and press the headrest downward again to lock it in place.

When adjusting the headrest, the proper position is when the center of the headrest is level with the top of your ears.



i Tips

- The lowest position of the headrest is not a usable position. Always raise the headrest to a locked position before use.
- The headrest on the driver's seat cannot be removed.



Driver's Usage Habits

Save habits



Method 1:

1. Adjust the seat position to a suitable setting.
2. After the adjustment is complete, a pop-up window appears in the touchscreen. Tap **"Save"** to save the current seat position. Tap **"Restore"** to automatically restore the seat position to the last saved position.

Tips



The pop-up screen disappears automatically after a period of time.

Method 2:

1. In the touchscreen, tap in sequence " →  → **Seat Position** → **Select "Driver Seat"** → **Position Adjustment**" to enter the Driver - Position Adjustment screen.
2. Adjust the seat position to a suitable setting.

3. After the adjustment is complete, tap **"Save Habits"** to save the current seat position. Tap **"Restore"** to automatically restore the seat position to the last saved position.

Switching habits

After logging into your account, tap in sequence in the touchscreen " →  → **Seat Position** → **Select "Driver Seat"** → **Driving Habits**" to enter the driving habit screen, where you can select stored driving habits.

"Manage habits"

On the driving habit screen, you can add, delete, or rename the saved driver's driving habits. Each account can store up to 6 driving preferences.

- **Add habits:** On the driving habit screen, tap **"Add"**, enter a name for the driving habit, and then tap **"Confirm"** to complete the addition.
- **Delete habits:** On the driving habit screen, tap **"Edit"**, select the driving habits you want to delete, tap the delete icon, and then tap **"Confirm"** to complete the deletion.



- **Rename:** On the Driving habit screen, tap “**Edit**”, select the driving habit to be renamed, tap the rename icon, enter a new driving habit name, and then tap “**OK**” to complete the renaming.

Foldable Table on Driver Seatback

A folding tray table is provided on the back of the driver’s seat. To use it, press the switch and lower the table to the horizontal position; after use, fold it back into place. When you hear a “click,” the table is securely closed.



caution

The maximum load capacity of this folding table is 10 kg. Overloading is strictly prohibited to avoid damage.

warning

- Pay attention to the rotating structure when operating the folding table and carefully pinch your hands.
- Do not use while the vehicle is in motion.
- Follow the rules for use, as serious injury or death may result.

Front Seat

Adjust Front Passenger Seat Position

You can adjust the front passenger seat to a suitable position in any of the following ways:

- Adjust the seat position using the seat switch.
- Adjust the seat position using the touchscreen.

Interior Functions



- Adjust the seat position using voice commands.

Adjusting the fore-aft position using the seat switch

Move this adjustment switch forward or backward to adjust the fore-aft position of the front passenger seat.



Adjusting the seat height with the seat switch

Push the rear of this adjustment switch up or down to adjust the height of the front passenger seat.

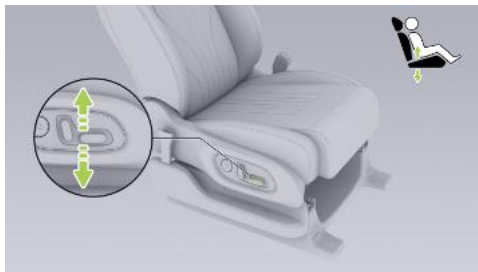

Adjusting the seatback angle with the seat switch

Move the top of this adjustment switch forward or backward to adjust the recline angle of the front passenger seatback.



Adjustment via the touchscreen

In the touchscreen, tap in sequence “ → → **Seat Position** → Select “**Front Passenger Seat**” → **Position Adjustment**” to enter the front passenger seat adjustment screen, then select “**Seat**”.

- Height: Tap or to adjust the seat height step by step. Press and hold to continuously adjust the seat height. You can also tap or slide the slider to quickly adjust the seat height.

- Position: Tap or to adjust the seat fore-aft position step by step. Press and hold to continuously adjust the seat fore-aft position. You can also tap or drag the slider to quickly adjust the seat fore-aft position.
- Backrest angle: Tap or to adjust the seatback angle step by step. Press and hold to continuously adjust the seatback angle. You can also tap or slide the slider to quickly adjust the seatback angle.

Adjust Front Passenger Seat Cushion Height

You can adjust the front passenger seat cushion to a suitable position using any of the following methods:

- Adjust the seat cushion using the seat switch.
- Adjust the seat cushion using the touchscreen.
- Adjust the seat cushion using voice commands.





Adjusting seat cushion height with the seat switch

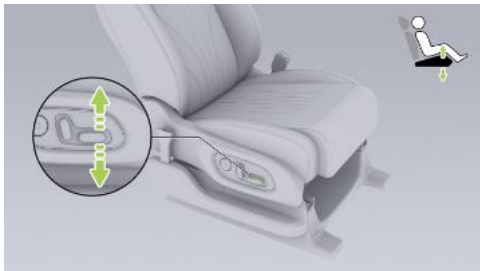

Push the front part of this adjustment switch upward or downward to adjust the height of the front passenger seat cushion.



Adjusting seat cushion height with the touchscreen

In the touchscreen, tap “ →  → **Seat Position** → **Select “Front Passenger Seat”** → **Position Adjustment**” to enter the front

passenger seat adjustment screen, then select “**Cushion**”.

- Height: Tap  or  to adjust the cushion height step by step. Press and hold to continuously adjust the cushion height. You can also tap or slide the slider to quickly adjust the cushion height.

Adjust Front Passenger Seat Lumbar Support

You can adjust the front passenger seat lumbar support in any of the following ways:

- Adjust the seat lumbar support using the seat switch.
- Adjust the seat lumbar support using the touchscreen.
- Adjust the seat lumbar support using voice commands.





Adjusting the seat lumbar support with the seat switch

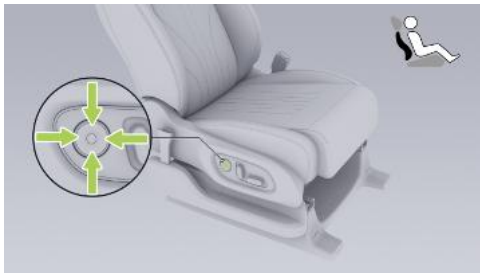



- Press the Up/Down button to adjust the raised height of the lumbar support.
- Press the Left/Right button to adjust the raised position of the lumbar support.



Adjusting the seat lumbar support with the touchscreen

In the touchscreen, tap in sequence “ →  → **Seat Position** → Select “**Front Passenger Seat**” → **Position Adjustment**” to enter the front

passenger seat adjustment screen, then select “**Lumbar Support**”.

- Height: Tap  or  to adjust the raised height of the front passenger seat lumbar support.
- Position: Tap  or  to adjust the raised position of the front passenger seat lumbar support.

Rear Seat Adjustment of Front Passenger Seat Position

The front passenger seat is equipped with a master key, allowing rear-row occupants to adjust the front passenger seat position using the key.

Adjusting the front passenger seat fore-and-aft position

Move this adjustment switch forward or backward to adjust the fore-aft position of the front passenger seat.





Adjusting the front passenger seatback angle

Move the top of this adjustment switch forward or backward to adjust the recline angle of the front passenger seatback.



Adjusting the front passenger seat position from the rear entertainment screen

On the rear entertainment screen, tap “ → **Seat Adjustment** → **Select “Front Passenger Seat”**” to enter the front passenger seat adjustment screen.

- **Seatback Adjustment:** Tap “” and then the corresponding “<”/“>” switch to adjust the front passenger seatback angle.
- **Seat Fore-and-Aft Adjustment:** Tap “” and then the corresponding “<”/“>” switch



to adjust the front passenger seat fore-and-aft position.

Front Passenger Seat Headrest

Adjusting head headrest height

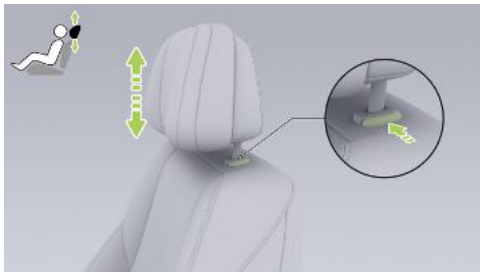

- Adjustment upward: Lift the headrest upward to a suitable position, then press it downward to make sure it is locked in place.
- Adjustment downward: Press and hold the headrest adjustment button, move the headrest downward to a suitable position, then

release the button and press the headrest downward again to lock it in place.

When adjusting the headrest, the proper position is when the center of the headrest is level with the top of your ears.



i Tips

The lowest position of the headrest is not a usable position. Always raise the headrest to a locked position before use.



Removing the seat headrest

You can remove the headrest by following these steps:

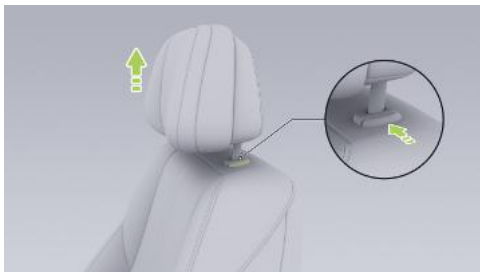

1. Lift the headrest upward to its highest position.
2. Press the headrest release button and pull the headrest upward to remove it.

i Tips

If removal is necessary, adjust the seat backrest rearward to allow the head restraint to be removed smoothly.

! warning

Do not ride in the vehicle with the headrest removed. The headrest should be installed on the seats and adjusted to a proper position.

Installing the seat headrest

When installing the seat headrest, align the headrest posts with the mounting holes in the seat and press the headrest straight down. Adjust the headrest height to a suitable position.

Front Passenger Seat Memory

Saving Seat Memory

Method 1:

1. Adjust the seat position to a suitable setting.





2. After the adjustment is complete, a pop-up window appears in the touchscreen. Tap **“Save”** to save the current seat position. Tap **“Restore”** to automatically restore the seat position to the last saved position.



Tips

The pop-up screen disappears automatically after a period of time.

Method 2:

1. In the touchscreen, tap in sequence “ →  → **Seat Position** → **Select “Front Passenger Seat”** → **Position Adjustment**” to enter the Front Passenger – Position Adjustment screen.
2. Adjust the seat position to a suitable setting.
3. After adjustment is complete, tap **“Save Memory”** to store the current seat position as the Standard, Relax, or Nap memory position; tap **“Restore”** to automatically return the seat to the last saved position.

Switch Seat Memory

In the touchscreen, tap in sequence “ →  → **Seat Position** → **Select “Front Passenger Seat”** → **Seat Memory**” to enter the Front Passenger – Seat Memory screen, where you can select a stored seat position.

On the Front Passenger – Seat Memory screen, tap in sequence **“Edit”** → **Select “Standard,” “Relaxed,” or “Nap”** → **Modify**” to rename a stored memory setting.

Foldable Table on Front Passenger Seatback

A folding tray table is provided on the back of the front passenger seat. To use it, press the switch and lower the table to the horizontal position; after use, fold it back into place. When you hear a “click,” the table is securely closed.



caution

The maximum load capacity of this folding table is 10 kg. Overloading is strictly prohibited to avoid damage.

warning

- Pay attention to the rotating structure when operating the folding table and carefully pinch your hands.
- Do not use while the vehicle is in motion.

- Follow the rules for use, as serious injury or death may result.

Second row seats

Adjust Second Row Seat Position

You can adjust the second-row seat to a suitable position using any of the following methods:

- Adjust the seat position using the seat switch.
- Adjust the seat position using the touchscreen.
- Adjust the seat position using voice commands.

Adjusting the fore-aft position using the seat switch

Move this adjustment switch forward or backward to adjust the fore-aft position of the second-row seat.



Adjusting the seatback angle with the seat switch

Move the top of this adjustment switch forward or backward to adjust the recline angle of the second-row seatback.



Adjustment via the touchscreen

In the touchscreen, tap in sequence “ → → **Seat Position** → Select “**Second-row Left Seat**” or “**Second-row Right Seat**” → **Position Adjustment**” to enter the adjustment screen for the second-row left or right seat, then select “**Seat**”.

- Position: Tap < or > to adjust the seat fore-aft position step by step. Press and hold to continuously adjust the seat fore-aft position.

Interior Functions



You can also tap or drag the slider to quickly adjust the seat fore-aft position.

- Angle: Tap < or ∨ to adjust the seatback angle step by step. Press and hold to continuously adjust the seatback angle. You can also tap or slide the slider to quickly adjust the seatback angle.

Adjust Second Row Seat Leg Support

You can adjust the second-row seat leg rest using any of the following methods:

- Adjust the seat leg rest using the seat switch.
- Adjust the seat leg rest using the touchscreen.
- Adjust the seat leg rest using voice commands.

Adjusting the seat leg rest with the seat switch

Push this adjustment switch up, down, left, or right to adjust the seat leg rest.



Adjusting the seat leg rest with the touchscreen

In the touchscreen, tap in sequence “☰ → ↙ → **Seat Position** → Select “**Second-row Left Seat**” or “**Second-row Right Seat**” → **Position Adjustment**” to enter the adjustment screen for the second-row left or right seat, then select “**Leg Rest**”.

- Angle: Tap ^ or > to adjust the leg rest angle step by step. Press and hold to continuously adjust the leg rest angle. You can also tap or



slide the slider to quickly adjust the leg rest angle.

- Position: Tap < or > to adjust the leg rest position step by step. Press and hold to continuously adjust the leg rest position. You can also tap or slide the slider to quickly adjust the leg rest position.

Adjust Second Row Seat Lumbar Support

You can adjust the second-row seat lumbar support using any of the following methods:

- Adjust the seat lumbar support using the seat switch.
- Adjust the seat lumbar support using the touchscreen.
- Adjust the seat lumbar support using voice commands.

Adjusting the seat lumbar support with the seat switch

- Press the Up/Down button to adjust the raised height of the lumbar support.
- Press the Left/Right button to adjust the raised position of the lumbar support.



Adjusting the seat lumbar support with the touchscreen

In the touchscreen, tap in sequence “ → → **Seat Position** → Select “**Second-row Left Seat**” or “**Second-row Right Seat**” → **Position**



Adjustment to enter the adjustment screen for the second-row left or right seat, then select **“Lumbar Support”**.

- Height: Tap \wedge or \vee to adjust the raised height of the second-row seat lumbar support.
- Position: Tap \lt or \gt to adjust the raised position of the second-row seat lumbar support.

Adjust Second Row Zero-Gravity Mode Pitch Angle

You can adjust the pitch angle of the second-row seat Zero Gravity mode using any of the following methods:

- Adjust the pitch angle of the second-row seat Zero Gravity mode using the seat switch.
- Adjust the pitch angle of the second-row seat Zero Gravity mode using the touchscreen.
- Adjust the pitch angle of the second-row seat Zero Gravity mode using voice commands.

Adjusting the pitch angle of the second-row seat Zero Gravity mode with the seat switch

Push the front of this adjustment switch up or down to adjust the pitch angle of the second-row seat.



Adjusting the pitch angle of the second-row seat Zero Gravity mode with the touchscreen

In the touchscreen, tap in sequence “ →

→ **Seat Position** → Select **“Second-row Left Seat”** or **“Second-row Right Seat”** → **Position**

Adjustment to enter the adjustment screen for



the second-row left or right seat, then select **“Zero Gravity”**.

Tap \vee or \triangleright to adjust the seat pitch angle position step by step. Press and hold to continuously adjust the seat pitch angle. You can also slide the slider directly to quickly adjust the seat pitch angle position.

Second Row Seat Headrest

The second-row headrests support manual adjustment and removal.

Adjusting head headrest height

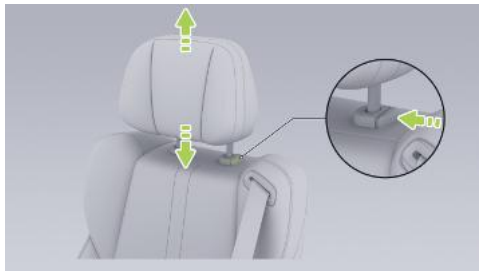

- Adjustment upward: Lift the headrest upward to a suitable position, then press it downward to make sure it is locked in place.
- Adjustment downward: Press and hold the headrest adjustment button, move the headrest downward to a suitable position, then release the button and press the headrest downward again to lock it in place.

When adjusting the headrest, the proper position is when the center of the headrest is level with the top of your ears.



i Tips

The lowest position of the headrest is not a usable position. Always raise the headrest to a locked position before use.

Removing the seat headrest

You can remove the headrest by following these steps:

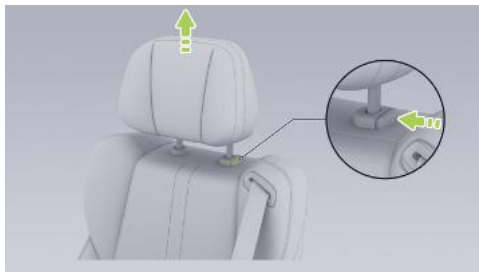

1. Lift the headrest upward to its highest position.
2. Press the headrest release button and pull the headrest upward to remove it.

i Tips

If removal is necessary, adjust the seat backrest rearward to allow the head restraint to be removed smoothly.



warning

Do not ride in the vehicle with the headrest removed. The headrest should be installed on the seats and adjusted to a proper position.

Installing the seat headrest

When installing the seat headrest, align the headrest posts with the mounting holes in the seat and press the headrest straight down. Adjust the headrest height to a suitable position.

One-touch Second Row Zero-Gravity Mode

In Zero-Gravity mode, the second-row seats automatically adjust to the most relaxed posture for the human body, ensuring even support for the passenger's spine and enhancing seating comfort.

You can enter or exit second-row Zero-Gravity mode using any of the following methods:

- Enter or exit Zero-Gravity mode using the seat switch.

- Enter or exit Zero-Gravity mode using the touchscreen.
- Enter or exit Zero-Gravity mode using the rear entertainment screen.
- Enter or exit Zero-Gravity mode using voice commands.

Entering/exiting Zero-Gravity mode with the seat switch





1. Zero-Gravity mode switch



- Press the switch to enter Zero-Gravity mode; the seat will adjust to the Zero-Gravity mode position.
2. One-click Restore switch
- Press the switch to exit Zero-Gravity mode; the seat will automatically return to its previous position.

Entering/exiting Zero-Gravity mode via the touchscreen

In the touchscreen, tap in sequence “ →  → **Seat Position** → **Select “Second-Row Left Seat” or “Second-Row Right Seat”**” to enter the adjustment screen for the second-row left or right seat.

- Tap “**Zero-Gravity**” to enter Zero-Gravity mode; the seat will adjust to the Zero-Gravity mode position.
- Tap “**One-click Restore**” to exit Zero-Gravity mode; the seat will automatically return to its previous position.

Entering/exiting Zero-Gravity mode via the rear entertainment screen

On the rear control screen, tap in sequence “ → **Seat Adjustment** → **Select “Second-Row Left Seat” or “Second-Row Right Seat”**” to enter the adjustment screen for the second-row left or right seat.

- Tap “**Zero-Gravity**” to enter Zero-Gravity mode; the seat will adjust to the Zero-Gravity mode position.
- Tap “**One-click Restore**” to exit Zero-Gravity mode; the seat will automatically return to its previous position.

Tips

- If the driver or front passenger seat is positioned too far back and is unoccupied, the front seat will first move forward to provide clearance and then enter Zero Gravity mode.
- If the driver or front passenger seat is positioned too far back and is occupied, the



second-row leg rest may not be able to fully extend in Zero Gravity mode.

- If the driver or front passenger seatback is reclined too far and the seat is occupied, Zero Gravity mode may not be available. Adjust the driver or front passenger seat and then try again.
- If the third-row seatback is too far forward, the second-row seat on the same side may not be able to enter Zero Gravity mode. When the third-row seatback is folded, the second-row seat on the same side cannot enter Zero Gravity mode. Adjust the third-row seat and then try again.

Easy Entry&Exit for Third Row Seats

The Easy Entry/Exit function is designed to provide third-row passengers with a more spacious and convenient entry and exit passage. When this function is activated, the second-row seats automatically move forward, recline the backrests, and retract the leg rests. After passengers have entered or exited the vehicle,

deactivate this function and the second-row seats will return to their default positions.

You can turn the Easy Entry/Exit function on or off using any of the following methods:

- Turn the Easy Entry/Exit function on or off using the physical switch.
- Turn the Easy Entry/Exit function on or off using the touchscreen.
- Turn the Easy Entry/Exit function on or off using the rear entertainment screen.
- Turn the Easy Entry/Exit function on or off using voice commands.

i Tips

- When the Entry/Exit function is enabled, if the corresponding front seat is unoccupied, that front seat will automatically move forward to provide clearance.
- While the second-row seat is moving, it will stop immediately if any second-row seat switch is pressed, if someone sits in the second-row seat, if the vehicle is not in Park



(P), or if the vehicle speed is greater than zero.

Turning the Easy Entry/Exit function on/off with the physical switch

The physical switches for the Easy Entry/Exit function are located on the side of the second-row seat and on the back of the seatback; both locations can be used for operation.

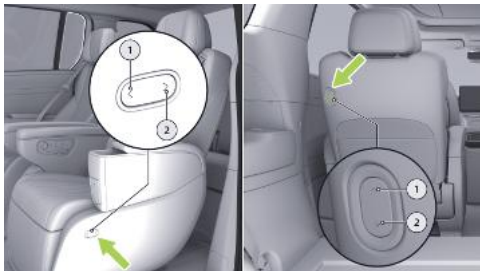

- On: Press switch ① to activate the Easy Entry/Exit function.

- Off: Press switch ② to deactivate the Easy Entry/Exit function.

Activating the Easy Entry/Exit function via the touchscreen

In the touchscreen, tap in sequence “ → → **Seat Position** → Select “**Second-Row Left Seat**” or “**Second-Row Right Seat**”” to enter the adjustment screen for the second-row left or right seat.

Tap “**Easy Entry/Exit**” to enable the Easy Entry/Exit function.

Activating the Easy Entry/Exit function via the rear entertainment screen

On the rear control screen, tap in sequence “ → → **Seat Adjustment** → Select “**Second-Row Left Seat**” or “**Second-Row Right Seat**”” to enter the adjustment screen for the second-row left or right seat.

Tap “**Easy Entry/Exit**” to enable the Easy Entry/Exit function.



Second Row Seat Memory

Saving Seat Memory

1. In the touchscreen, tap in sequence “ → → **Seat Position** → **Select “Second-Row Left Seat” or “Second-Row Right Seat”** → **Position Adjustment** to enter the adjustment screen for the second-row left or right seat.
2. Adjust the seat position to a suitable setting.
3. After adjustment is complete, tap “**Save Memory**” to store the current seat position as the Standard, Relax, or Nap memory position; tap “**Restore**” to automatically return the seat to the last saved position.

Switch Seat Memory

You can switch seat memory positions in any of the following ways:

- In the touchscreen, sequentially tap “ → → **Seat Position** → **Select “Second-row Left Seat” or “Second-row Right Seat”** → **Seat Memory** to enter the second-row left or right

seat memory screen, where you can select a stored seat position.

- On the rear entertainment screen, sequentially tap “ → **Seat Adjustment** → **Select “Second-row Left Seat” or “Second-row Right Seat”** → **Seat Memory** to enter the second-row left or right seat memory screen, where you can select a stored seat position.

On the second-row left or right seat memory screen, sequentially tap “**Edit** → **Select “Standard, Relax, or Nap”** → **Modify**” to rename a saved memory setting.

Third row seats

Adjust Third Row Seatback

You can adjust the third-row seatback angle in any of the following ways:

- Adjust the seatback angle using the seat switch.
- Adjust the seatback angle using the touchscreen.



- Adjust the seatback angle using the rear entertainment screen.
- Adjust the seatback angle using voice commands.

Adjusting the seatback angle with the seat switch

The third-row seatback angle adjustment switch is located on the third-row armrest. Push this adjustment switch forward or backward to adjust the third-row seatback angle.



Adjusting the seatback angle with the touchscreen

In the touchscreen, sequentially tap “ → → **Seat Position** → **Select “Third-row Left Seat” or “Third-row Right Seat”** → **Position Adjustment**” to enter the third-row left or right seat adjustment screen, then select “**Seat**”.

Tap or to adjust the third-row seatback angle step by step. Press and hold to continuously adjust the third-row seatback angle. You can also tap or slide the slider to quickly adjust the third-row seatback angle.

Adjusting the seatback angle with the rear entertainment screen

On the rear control screen, sequentially tap “ → → **Seat Adjustment** → **Select “Third-row Left Seat” or “Third-row Right Seat”**” to enter the third-row left or right seat adjustment screen, then select “**Seat**”.

Tap or to adjust the third-row seatback angle step by step. Press and hold to



continuously adjust the third-row seatback angle. You can also tap or slide the slider to quickly adjust the third-row seatback angle.

Third Row Seat Headrest

The third-row seat headrests support electric adjustment and cannot be removed.

You can adjust the third-row seat headrests in any of the following ways:

- Adjust the headrests using the head restraint switch.
- Adjust the headrests using the touchscreen.
- Adjust the headrests using the rear entertainment screen.
- Adjust the headrests using voice commands.

Adjusting the headrests with the headrest switch

The outer headrest switches are located on the armrests on both sides. Push these switches forward or backward to adjust the height of the outer headrests.



The adjustment switch for the center headrest is located on its side. Press the front or rear of the switch to adjust the height of the center headrest.

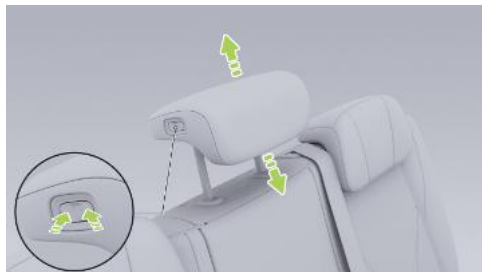

Adjusting the right seat headrest via the touchscreen

In the touchscreen, sequentially tap “ → → **Seat Position** → Select “**Third-row Right Seat**” → **Position Adjustment**” to enter the third-row right seat adjustment screen, then select “**Headrest**”.

Tap or to adjust the height of the right seat headrest.

Adjusting the left/center headrests with the touchscreen

In the touchscreen, sequentially tap “ → → **Seat Position** → Select “**Third-row Left Seat**” → **Position Adjustment**” to enter the third-row left seat adjustment screen, then select “**Center Headrest**” or “**Outer Headrest**”.

Tap or to adjust the height of the center seat headrest or the left seat headrest.

Adjusting the left/center seat headrest via the rear entertainment screen



On the rear control screen, sequentially tap “ → **Seat Adjustment** → Select “**Third-row Left Seat**”” to enter the third-row left seat adjustment screen, then select “**Center Headrest**” or “**Outer Headrest**”.

Tap or to adjust the height of the center seat headrest or the left seat headrest.



Adjusting the right seat headrest via the rear entertainment screen

On the rear control screen, sequentially tap “ → **Seat Adjustment** → **Select “Third-row Right Seat”**” to enter the third-row right seat adjustment screen, then select “**Headrest**”.

Tap  or  to adjust the height of the right seat headrest.

One-touch Fold&Flip and Stow Third Row Seats

The third-row seats support one-touch folding, flip-down, and stowing, which can effectively expand the vehicle’s cargo space and greatly improve space utilization.

You can fold, flip down, and stow the third-row seats with one touch using any of the following methods:

- Using the folding switches.
- Using the touchscreen.
- Using voice commands.

Operating the folding switches

The folding switches are located on the right side of the trunk. The upper switch controls the right seat, and the lower switch controls the left seat.





- One-touch folding: Briefly press the switch. The third-row seat headrests lower to the lowest position and the backrests fold down.
- One-touch unfolding: Briefly pull the switch. After the backrests gradually return to their original positions, the third-row seat headrests return to their original positions.

Interior Functions



- Flip down and stow: Press and hold the switch for at least 2 seconds to flip the third-row seats down and stow them into the trunk.
- Seat restoration: Pull and hold the switch for at least 2 seconds to return the third-row seats to the seating position.

Operating via the touchscreen

In the touchscreen, sequentially tap “ → 
→ **Seat Position** → **Select “Third-row Left Seat” or “Third-row Right Seat”** → **Position Adjustment** to enter the third-row left or third-row right seat adjustment screen.

- Tap “**Backrest Fold**” to fold/unfold the third-row left or third-row right seat backrest with one touch.
- Tap “**Flip down and stow**” to flip the third-row left or third-row right seats down and stow them into the trunk. Before restoring them from the stowed position, make sure the cargo cover is flat. Tap “**Flip down and stow**” again to return the seats to the seating position.



Operating via the rear entertainment display

On the rear control display, sequentially tap “
→ **Seat Adjustment** → **Select “Third-row Left Seat” or “Third-row Right Seat”** → **Position Adjustment** to enter the third-row left or third-row right seat adjustment screen.

- Tap “**Backrest Fold**” to fold/unfold the third-row left or third-row right seat backrest with one touch.
- Tap “**Flip down and stow**” to flip the third-row left or third-row right seats down and stow



them into the trunk. Before restoring them from the stowed position, make sure the cargo cover is flat. Tap **“Flip down and stow”** again to return the seats to the seating position.

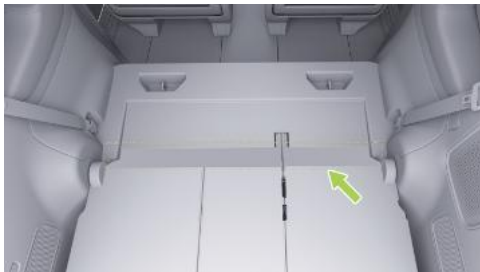

caution

- One-touch folding and flip-and-stowing require certain conditions to be met, such as: the vehicle is in P, no one is seated in the third row, the seats have been initialized, the second-row seat position is appropriate, and none of the third-row seat belts are buckled, etc.

- The second-row seats will only automatically move forward to provide space for one-touch folding and flip-and-stowing when no one is seated in the second row.
- To avoid seat damage, remove any items from the seat cushions and the trunk before performing one-touch folding or flip-and-stowing. If an obstacle is detected during one-touch folding or flip-and-stowing, the seat will stop moving.
- Under special conditions such as remaining range ≤ 30 km, high-voltage system faults, or extreme high or low ambient temperatures, the third-row seats may not be able to flip. The seat flip function will only resume after the vehicle voltage and ambient temperature have returned to normal.





Seat Heating&Ventilation&Massage

Seat Heating Function

You can turn the Seat Heating function on or off in the following ways:

- Using the touchscreen.
- Using the rear entertainment screen.
- By using the second-row seat heating switch.
- By using the third-row seat heating switch.
- By using the mobile App.
- Using voice commands.

Control via touchscreen

In the touchscreen, tap in sequence “ →  → **Heating/Ventilation**” to enter the “**Heating/Ventilation**” settings interface.

- Tap “ ” to turn on the corresponding seat heating function. The level will be set to level 3. Repeatedly tap to cycle through level 2, level 1, off, and back to level 3.

- Tap “**Close All**” to turn off all seat heating, seat ventilation, and steering wheel heating functions.

Control via rear entertainment screen

On the rear control screen, tap “ → **Heating/Ventilation**” to enter the “**Heating/Ventilation**” settings interface.

- Tap “ ” to turn on the corresponding second-row seat heating function. The level will be set to level 3. Repeatedly tap to cycle through level 2, level 1, off, and back to level 3.

Tips

- The seat heating and ventilation functions cannot be turned on at the same time.
- The rear entertainment screen only supports control of the second-row seat heating function.

Second-row seat heating switch control

Press the second-row seat heating switch to turn on the seat heating function. The level will be



set to level 3. Repeatedly press to cycle through level 2, level 1, off, and back to level 3. The switch indicator light will change along with the level.



Third-row seat heating switch control

Press the third-row seat heating switch to turn on the seat heating function. The level will be set to level 3. Repeatedly press to cycle through level 2, level 1, off, and back to level 3. The switch indicator light will change along with the level.



Control via mobile App

In the mobile App “XPENG→Intelligent Air Conditioner”, tap the corresponding seat  to turn on the seat heating function. The level will be set to level 3. Repeatedly tap to cycle through level 2, level 1, off, and back to level 3.



i Tips

During a single power cycle, if the seat ventilation or heating function is on, and the user leaves the corresponding seat position for more than 30 seconds, the seat ventilation or heating function will automatically turn off and the seat ventilation or heating level will be memorized. During a single power cycle, if the user leaves the seat for 30 seconds, triggering the automatic shutdown of the seat ventilation or heating function, and the user sits down again, the seat ventilation or heating function

will automatically turn on 5 seconds later according to the memorized seat ventilation or heating level.

! caution

- It is recommended not to activate Seat Heating for unoccupied seats to avoid wasting energy or causing other losses.
- When using the Seat Heating function, do not place additional items such as blankets or seat cushions on the seat, as this may cause the seat temperature to become excessively high, potentially resulting in heater malfunction or damage to the seat.
- If a child safety seat is installed on the second-row or third-row seat, do not activate the Seat Heating function.

! warning

- Do not use the seat heating function if the person in contact with the seat does not feel pain, as personal injury may result.



- Extended use of a high-speed heated seat can cause cold burns.
- Using the host seat heating for extended periods of time may cause distress and affect safety.

Seat Ventilation Function

You can turn the Seat Ventilation function on or off in the following ways:

- Using the touchscreen.
- Using the rear entertainment screen.
- By using the second-row seat ventilation switch.
- By using the mobile App.
- Using voice commands.

Control via touchscreen

On the center control screen, tap in sequence “ → → **Heating/Ventilation**” to enter the “**Heating/Ventilation**” settings interface.

- Tap “” to turn on the corresponding Seat Ventilation function. The level will be set to level 3. Repeatedly tap to cycle through level 2, level 1, off, and back to level 3.
- Tap “**Close All**” to turn off all seat heating, seat ventilation, and steering wheel heating functions.

Control via rear entertainment screen

On the rear control screen, tap “ → **Heating/Ventilation**” to enter the “**Heating/Ventilation**” settings interface.

- Tap “” to turn on the corresponding second-row seat ventilation function. The level will be set to level 3. Repeatedly tap to cycle through level 2, level 1, off, and back to level 3.

Tips

- The seat heating and ventilation functions cannot be turned on at the same time.



- The rear entertainment screen only supports control of the second-row seat ventilation function.

Second-row seat ventilation switch control

Press the second-row seat ventilation switch to turn on the seat ventilation function. The level is set to level 3. Press repeatedly to cycle through level 2, level 1, Off, and back to level 3. The indicator on the switch changes according to the selected level.



Control via mobile App



In the mobile App “XPENG→Intelligent Air Conditioner”, tap the corresponding seat  to turn on the seat ventilation function. The level is set to level 3. Tap repeatedly to cycle through level 2, level 1, Off, and back to level 3.

Tips

During a single power cycle, if the seat ventilation or heating function is on, and the user leaves the corresponding seat position for more than 30 seconds, the seat ventilation or heating function will automatically turn off and the seat ventilation or heating level will be memorized. During a single power cycle, if the user leaves the seat for 30 seconds, triggering the automatic shutdown of the seat ventilation or heating function, and the user sits down again, the seat ventilation or heating function will automatically turn on 5 seconds later according to the memorized seat ventilation or heating level.



i Tips

- The seat heating and ventilation functions cannot be turned on at the same time.
- Only the first- and second-row seats support the Seat Ventilation function.

! caution

- It is recommended not to turn on the Seat Ventilation function for unoccupied seats to avoid wasting energy or causing other loss or damage.
- If a child safety seat is installed on a second-row seat, do not turn on the Seat Ventilation function.

Seat Massage Function

You can turn the Seat Massage function on or off in the following ways:

- Using the second-row seat massage switch.
- Using the touchscreen.
- Using the rear entertainment screen.

- Using voice commands.



Second-row seat massage switch control



1. Massage mode switch
 - Press to switch the massage mode.
2. Massage intensity adjustment switch
 - Press to turn on the Seat Massage function. The intensity is set to level 3. Press repeatedly to cycle through level 2, level 1, Off, and back to level 3. The indicator on the switch changes according to the selected level.



Control via touchscreen

In the touchscreen, tap in sequence “ →  → **Seat massage**” to enter the “**Seat massage**” settings screen.

- Tap “” to turn on the massage function for the corresponding seat. The massage intensity is set to level 3. Tap repeatedly to cycle through level 2, level 1, Off, and back to level 3.
- Tap “**Close all**” to turn off the massage function for all seats.
- After tapping the massage mode name for the corresponding seat, you will enter the seat massage settings screen, where you can configure “**Seat massage**” and “**Waist Soothing**” separately.

“Message”

1. You can select the massage mode according to personal preference.
2. Tap to turn the Seat Massage function on or off.

3. Tap to select the massage intensity.

Waist Soothing

1. You can select the waist pressure-relief mode according to personal preference.
2. Tap to turn the waist pressure-relief function on or off.

Control via rear entertainment screen

On the rear control screen, tap “ → **Seat massage**” to enter the “**Seat massage**” settings screen.

- Tap “” to turn on the massage function for the corresponding seat. The massage intensity is set to level 3. Tap repeatedly to cycle through level 2, level 1, Off, and back to level 3.
- After tapping the massage mode name for the corresponding seat, you will enter the seat massage settings screen.
 1. Tap to turn the Seat Massage function on or off.



2. Tap to select the massage intensity.
3. You can select the massage mode according to personal preference.

i Tips

During a single power-up cycle, the seat massage function is switched on and automatically switched off after the user has left the seat for more than 30 seconds in relation to the seat position.

i Tips

- Only the first- and second-row seats support the Seat Massage function.
- Different massage modes correspond to different massage durations; when the set time is reached, the seat massage will turn off automatically.

! caution

If a child safety seat is installed on a second-row seat, do not turn on the Seat Massage function.

Seat Welcome Mode

When Seat Welcome Mode is enabled, the seat will automatically adjust to the welcome position when you enter or exit the vehicle, making it easier for you to get in and out.

Enable or disable Driver Seat Welcome

In the touchscreen, tap in sequence “ → **Settings** → **Vehicle** → **Lock/Unlock & Welcome** → **Driver seat welcome**” to enable or disable the Driver Seat Welcome function.

Enable or disable Driver Seat Welcome

In the touchscreen, tap in sequence “ → **Settings** → **Vehicle** → **Lock/Unlock & Welcome** → **Front passenger seat welcome**” to enable or disable the Front Passenger Seat Welcome function.



Enable or disable Rear Seat Welcome

In the touchscreen, tap in sequence “ → **Settings** → **Vehicle** → **Lock/Unlock & Welcome** → **Rear seat welcome**” to enable or disable the Rear Seat Welcome mode.

Tips

- If the driver or front passenger seatback is reclined to a large angle, moving the seat rearward may affect second-row passengers, and the welcome function will not be activated in this case.
- If the driver or front passenger seat is already positioned far to the rear and occupants can exit the vehicle easily, the welcome function will not be activated in this case.
- If the second-row seat is already positioned further back than it would be after the welcome adjustment and passengers can get in easily, the second-row seat welcome function will not be activated.

Seat Anti-pinch

caution

Even if the seat has an anti-pinch function, you should ensure that there are no people or objects obstructing the range of motion of the seat and track before adjusting it, otherwise it may cause personal injury or vehicle damage.

If excessive resistance is detected during the following operations, the anti-pinch function will be triggered:

- Adjusting the driver/front passenger seat fore-and-aft position and reclining the backrest.
- Adjusting the second-row seat fore-and-aft position, reclining the backrest, and adjusting the leg-rest angle (excluding leg-rest length).
- Adjusting the third-row seat backrest angle and flipping down an stowing the backrest.

Tips

- After the seat cushions are unlocked from the floor, the third row of seats will trigger



the anti-pinch mechanism to stop moving during the initial and final stages of the flipping and folding process.

- When the anti-pinch function is activated in the driver/passenger seat or the second-row seats, the movement will stop and the seats will retract a certain distance. When the anti-pinch function is activated in the third-row seats, the movement will stop.

Seat Initialization

Initializing the front and second-row seats

When using the front/second-row seats, if a malfunction occurs (for example, the seat cannot be adjusted using the switches, touchscreen, or voice control), you can try manually initializing the seats before using them again.

1. Push the seatback angle adjustment switch forward, and release the switch after the seatback moves to and stops at the foremost position.

2. Push the switch forward again to confirm it is at the foremost position, then release the switch.
3. Within 5 seconds, push the seatback angle adjustment switch forward again and hold it for more than 5 seconds. The seat will automatically start the initialization learning. At this point, you can release the adjustment switch.
4. Wait until the seat has come to a complete stop before using the seat again.

Third-row seat initialization

When using the third-row seats, if a malfunction occurs (for example, the seatback cannot be adjusted by the button, touchscreen, or voice), you can try manually initializing the seats before using them again.

1. Push the third-row seat seatback angle adjustment switch forward, and release the switch after the seatback is fully folded and has stopped moving.



2. Within 5 seconds, push the seatback angle adjustment switch forward again and hold it for more than 5 seconds. The seat will automatically start the initialization learning. At this point, you can release the adjustment switch.
3. Wait until the seat has come to a complete stop before using the seat again.

caution

- During initialization, the seat will automatically move to its limit positions in all directions. Before initialization, adjust the front and rear seats to a forward/rearward position to provide sufficient space for the seat being initialized to move, so as to avoid collision.
- If the seat switch (including via the touchscreen) is pressed during initialization, the initialization will pause.

Steering Wheel

Steering Wheel Buttons

Steering wheel button functions in normal driving

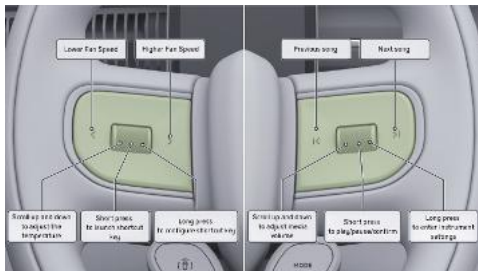

Tips

- After pressing and holding the scroll wheel to enter the instrument panel edit interface, you can adjust instrument panel-related functions using the left/right buttons and



the scroll wheel. For detailed operation, refer to the Instrument Panel section.

- In the exterior rearview mirror adjustment interface, you can adjust exterior rearview mirror-related functions using the left/right buttons and the scroll wheel. For detailed operation, refer to the Exterior Rearview Mirrors section.
- In the HUD adjustment interface. You can adjust HUD-related functions using the left/right buttons and the scroll wheel. For detailed operation, refer to the Head-Up Display (HUD) section.
- In the streaming interior rearview mirror adjustment interface, you can adjust streaming interior rearview mirror-related functions using the scroll wheel. For detailed operation, refer to the Streaming Interior Rearview Mirror section.
- When a call comes in, scroll the right-hand scroll wheel up or down to select Answer or Decline, then briefly press the scroll wheel to

confirm. While on a call, briefly press to hang up.

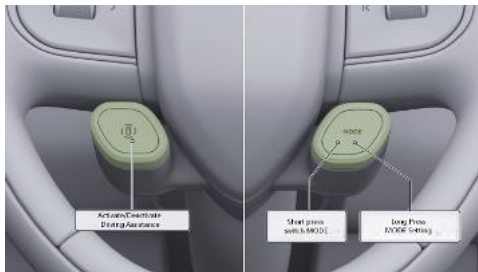

i Tips

- Only after the conditions for activating the driver assistance system are met can you briefly press the left intelligent drive control button to activate the driver assistance function. For detailed operation and instructions, refer to the relevant Driver Assistance sections.



- Before enabling the Driver Assistance function, read the relevant sections of this manual carefully to ensure you understand the operating instructions and all warnings and precautions for this function.

Steering wheel button functions in driver assistance

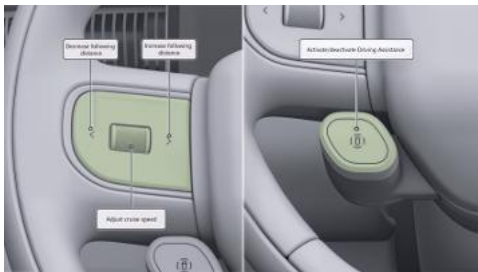

i Tips

The steering wheel buttons for adjusting following distance and cruise speed can only

be used when the LCC/NGP function is activated.

Steering wheel shortcut

Press and hold the steering wheel shortcut, or go to “ → **Settings** → **Vehicle** → **Seats & Steering Wheel** → **Steering Wheel Shortcut**” in the touchscreen, to set the function of the steering wheel shortcut.

Briefly press the steering wheel shortcut to perform the preset function.

MODE button

Press and hold the MODE button, or go to the touchscreen “ → **Settings** → **Vehicle** → **Seats & Steering Wheel** → **MODE Button**” interface to set the MODE button function.

Briefly press the MODE button to perform the preset function.



Horn

Press the area marked with the horn symbol to sound the horn.



caution

Do not press the horn indicator area for an extended period of time, as this may easily damage the horn.

Steering Wheel Position Adjustment

Before driving, adjust the steering wheel height and its distance from your body so you can

comfortably hold the steering wheel in a proper driving position.



1. Push the steering wheel release lever downward to unlock the steering wheel.
2. Move the steering wheel up, down, forward, or backward to a suitable position.
3. Pull the steering wheel release lever upward to lock the steering wheel.

Tips

- Please adjust the steering wheel position with the vehicle in P gear.



- After adjusting the steering wheel position, try moving the steering wheel up and down, forward and backward to make sure the steering wheel is locked firmly in place.

warning



- Do not adjust the steering wheel while the vehicle is in motion to avoid accidents.
- Improper steering wheel position adjustment can cause personal injury, at least 25cm from the steering wheel to the driver's chest.

Steering Wheel Heating Function

You can turn the steering wheel heating on or off in the following ways:

- Control the steering wheel heating via the touchscreen.
- Control the steering wheel heating via the mobile App.
- Control the steering wheel heating via voice commands.

Using the touchscreen

In the touchscreen “ →  → Heating/Ventilation” screen, tap “” to turn on the steering wheel heating. The level will be set to level 3. Repeatedly tapping will cycle through level 2, level 1, Off, and back to level 3.

Using the mobile App

In the mobile App “XPENG → Intelligent Air Conditioner”, tap “” to turn on the steering wheel heating. The level will be set to level 3. Repeatedly tapping will cycle through level 2, level 1, Off, and back to level 3.



Window Adjustment

Driver Window Switch

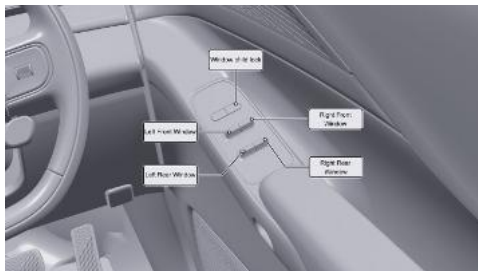

The driver-side window switches can raise or lower all four windows, while each passenger-side window switch can only raise or lower its corresponding window.

- Briefly pull the window switch backward for one-touch closing. The window will move to the fully closed position.



- Briefly push the window switch forward for one-touch opening. The window will move to the fully open position.
- Pull and hold the window switch backward to slowly raise the window; release to stop.
- Push and hold the window switch forward to slowly lower the window; release to stop.

Briefly press the window child lock button to turn the window child lock on or off. When it is turned on, the passenger-side window switches cannot control window opening or closing.

Front Passenger Window Switch



The front passenger-side window switch can raise or lower the front passenger window.

- Briefly pull the window switch backward for one-touch closing. The window will move to the fully closed position.
- Briefly push the window switch forward for one-touch opening. The window will move to the fully open position.
- Pull and hold the window switch backward to slowly raise the window; release to stop.



- Push and hold the window switch forward to slowly lower the window; release to stop.

Sliding Door Window Switch



The sliding door window switch can raise or lower the rear side window.

- Briefly push the window switch upward for one-touch closing. The window will move to the fully closed position.
- Briefly push the window switch downward for one-touch opening. The window will move to the fully open position.

- Push and hold the window switch upward to slowly raise the window; release to stop.
- Push and hold the window switch downward to slowly lower the window; release to stop.

Tips

- Do not switch the windows repeatedly within a short period of time, as this will trigger the window thermal protection, the window lift function will fail after thermal protection, wait approximately 2 minutes before operating.
- When the window is closed, if an obstacle is encountered in the anti-trap area, the window will stop closing and reverse for a distance.
- If the window is closed with one touch and the anti-trap function is disabled, the window initialization can be performed.

caution

Do not spray large amounts of cleaner directly on the window switch when cleaning the



interior trim, use a soft cloth dampened with cleaner to avoid damaging the switch.

warning

- To ensure safety when children are in the vehicle, lock the passenger glass up and down to prevent children from operating the windows to avoid pinching.
- Even if the windows are equipped with anti-trap, there is still a risk of pinching when closing the windows, do not use any part of your body to block the windows from closing to activate the anti-trap.
- Before closing the windows, the driver must ensure that all passengers, especially children, do not protrude any part of their body out of the window, otherwise there is a risk of pinching!
- Make sure the vehicle is powered down before leaving the vehicle.

Touchscreen Settings

In the touchscreen, tap “” to enter the Control Center screen, where you can set the windows to “**Fully Open, Ventilation, or Fully Closed**”.

Auto window closing

In the touchscreen, go to “” → **Settings** → **Vehicle** → **Doors & Windows**” to turn the “**Close Windows Automatically after Vehicle Locking**” and “**Close Windows Automatically when Traveling at High Speeds**” functions on or off.

Tips

After enabling automatic window closing at high speeds, it is recommended to switch to external air circulation mode when driving at high speeds.

warning

When the automatic window closing function is activated, the windows will automatically close



when the car is locked. Please ensure that the windows will not obstruct passengers or obstacles and that there are no passengers (especially children) inside the car before locking them.

Window Anti-pinch Function

This vehicle is equipped with a power window anti-pinch function. When the window encounters an obstacle while automatically closing, the anti-pinch function will be triggered, and the window will immediately stop closing and move downward by a certain distance.

Tips

If the anti-pinch function of the car window fails, you can perform a window initialization operation.

warning

- Even if the windows are equipped with anti-trap function, do not reach or extend any part of the body or other object into the

window during the window closing process, as this may cause injury to members or damage to the vehicle.

- Under special circumstances, such as thin or soft obstructions, the window anti-trap function will not be guaranteed to be triggered.

Window Initialization

Front window initialization

If an abnormality occurs when operating the front windows (such as failure of the anti-pinch function, failure of one-touch up/down, or adjustment not possible via the touchscreen or voice control), you can perform window initialization:

1. Power on the vehicle and close the doors. Pull and hold the window switch backward to raise the window to the fully closed position, keep holding for 2 seconds, and then release.
2. Briefly push the window switch forward. The window will automatically lower to the



fully open position and remain there for 2 seconds.

3. Briefly pull the window switch backward. The window will automatically raise to the fully closed position and remain there for 2 seconds, completing window initialization.

Perform the following operations to check whether initialization is complete:

1. Briefly push the window switch forward and release; the window can automatically lower to the fully open position.
2. Briefly pull the window switch backward and release; the window can automatically raise to the closed position.

Rear window initialization

If an abnormality occurs when operating the rear windows (such as failure of the anti-pinch function, failure of one-touch up/down, or adjustment not possible via the touchscreen or voice control), you can perform window initialization:

1. Power on the vehicle and close the doors. Push and hold the window switch upward to raise the window to the fully closed position, keep holding for 2 seconds, and then release.
2. Briefly push the window switch downward. The window will automatically lower to the fully open position and remain there for 2 seconds.
3. Briefly push the window switch upward. The window will automatically raise to the fully closed position and remain there for 2 seconds, completing window initialization.

Perform the following operations to check whether initialization is complete:

1. Briefly push the window switch downward and release; the window can automatically lower to the fully open position.
2. Briefly push the window switch upward and release; the window can automatically raise to the closed position.



Sunshade

Front Manual Sunshade

When in use, push the sunshade forward to its foremost position; when not in use, retract it rearward.



Rear Power Sunshade

You can open or close the rear electric sunshades in the following ways.

- Open or close the rear electric sunshades via the touchscreen.
- Open or close the rear electric sunshades via the mobile App.
- Open or close the rear electric sunshades via voice commands.

Opening/closing the rear electric sunshades via the touchscreen

In the touchscreen, tap “” to enter the Control Center screen, where you can set the sunshades to “**Fully Open, Stop, or Fully Closed**”. You can also enter the sunshade area and slide to adjust.

Opening/closing the rear electric sunshades via the mobile App

In the XPENG mobile App, on the “**XPENG**” page, tap “**Sunshades**” to open or close the rear electric sunshades.



Sunshade anti-pinch function

The vehicle is equipped with an anti-pinch function for the rear sunshades. When a sunshade is closing automatically and encounters an obstacle, the anti-pinch function is triggered, and the sunshade will immediately stop closing and retract slightly.

i Tips

If the sunshade anti-pinch function fails, you can perform sunshade initialization.

! warning

Even though the sunshade is equipped with an anti-pinch function, there is still a risk of pinching when closing it. Do not use any part of your body to block the sunshade in an attempt to trigger the anti-pinch function.

Sunshade initialization

If an abnormal condition occurs when operating the sunshades (for example, they cannot be adjusted via the touchscreen or voice control), you can perform sunshade initialization:

1. On the sunshade adjustment screen, press and hold **“Fully Closed”** for 3 seconds to start sunshade initialization.
2. The sunshades will adjust their positions automatically. When reset is successful, a message **“Sunshades Reset”** will be displayed, indicating that initialization is complete.



Window Sunshades

The rear side windows are equipped with sunshades. When in use, pull the sunshade up and secure it to the hooks at the top of the window. When not in use, retract the sunshade.





Exterior Lights

Position Lights

In low-light or low-visibility conditions, turning on the parking lights allows other road users to notice your vehicle.



You can turn on the parking lights in the following ways. When switched on, the  indicator light illuminates in the instrument panel:

- In the touchscreen, go to “ → **Settings** → **Vehicle** → **Lights**” to turn on the parking lights.
- In the touchscreen, tap  to enter the Control Center screen and turn on the parking lights.

Low Beam Headlights

You can turn on the low beam headlights in the following ways. When switched on, the  indicator light illuminates in the instrument panel:



- In the touchscreen, go to “ → **Settings** → **Vehicle** → **Lights**” to turn on the low beam headlights.
- In the touchscreen, tap  to enter the Control Center screen and turn on the low beam headlights.

High Beam Headlights

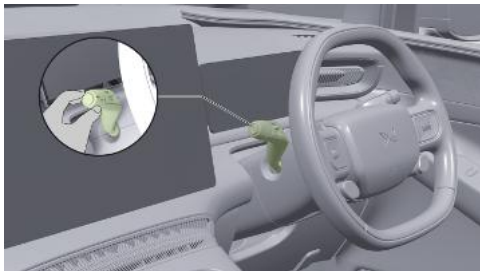

- **Turning on the high beam headlights:** With the low beam headlights on, push the left-hand stalk on the steering wheel forward to turn on the high beam headlights. At this time,

the  indicator light will be displayed on the instrument panel.

- **Turning off the high beam headlights:** When the high beam headlights are on, push or pull the left-hand stalk on the steering wheel to turn off the high beam headlights.
- **Passing signal:** Pull the left-hand stalk on the steering wheel toward you and release; the high beam headlights will flash once.

caution

- For your safety and that of others, use the high beam headlights appropriately.
- Under certain conditions (such as high humidity or when washing the vehicle), condensation may form inside the lamps. This is a normal phenomenon. If a large amount of condensation or standing water appears inside a lamp, contact an XPENG service center.



Automatic Headlights (AUTO)

You can activate the automatic headlight function in the following ways:



- In the touchscreen, go to “ → **Settings** → **Vehicle** → **Lights**” to turn on the automatic headlight function.
- In the touchscreen, tap  to enter the Control Center screen and turn on the automatic headlight function.

When the automatic headlight function is activated, the system automatically turns the low beam headlights and parking lights on or off according to the ambient brightness.

When the automatic headlight function is activated and the low beam headlights are on, the  indicator light illuminates in the instrument panel.

Rear Fog Lights

You can turn on the rear fog light in the following ways. When switched on, the  indicator light illuminates in the instrument panel:

- In the touchscreen, go to “ → **Settings** → **Vehicle** → **Lights**” to turn on the rear fog light.
- On the touchscreen, tap  to enter the Control Center screen and turn on the rear fog light.

Tips

With the low beam lamps off, the rear fog lamps are switched on and the low beam lamps will be switched on simultaneously.

Headlight Height Adjustment

In the touchscreen, go to “ → **Settings** → **Vehicle** → **Lights**” to select a headlight height level according to the vehicle load. When “**Auto**” is selected, the vehicle automatically



Interior Functions



adjusts the headlight height according to the load.

Condition	Headlight height position
Driver only	Very High
Driver and one front passenger only	
Front row and third row fully occupied	High
All seats occupied, or all seats occupied with approximately 60 kg of luggage in the trunk	Low
Driver only, with approximately 300 kg of luggage in the trunk	Very Low

Turn Off Lights

When the parking lights, low beam headlights, high beam headlights, rear fog light, or automatic headlight function are on, you can turn off all exterior lights in the touchscreen by going to “ →Settings→Vehicle→Lights”, or by tapping  to enter the Control Center screen.

Turn Signals

Turn signals are used to warn other road users that your vehicle is about to change its direction of travel.

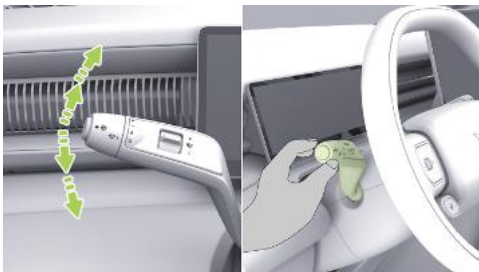

- Briefly move the lever downward and release it. The lever will return automatically, and the left turn signal will flash three times.
- Firmly move the lever downward to its end position and release it. The lever will return automatically, and the left turn signal will flash continuously.
- Briefly move the lever upward and release it. The lever will return automatically, and the right turn signal will flash three times.
- Firmly move the lever upward to its end position and release it. The lever will return

automatically, and the right turn signal will flash continuously.

- To turn off the turn signals, briefly move the lever up or down, or straighten the steering wheel.

i Tips

When a turn signal is activated, the corresponding turn indicator is displayed on the instrument panel and HUD, accompanied by a “click” sound.

Hazard Warning Lights

If an emergency occurs while driving, press the hazard warning light switch to turn on the hazard warning lights. The turn signals will flash. Press the switch again to turn off the hazard warning lights.



i Tips

The hazard warning lights can be turned on whether the vehicle is powered on or off.

Light Saber Mode

After Light Saber Mode is enabled, the front Position Light will be brighter during the daytime. Please determine whether it is necessary to enable this function based on actual conditions.

In the touchscreen, go to “ → **Settings** → **Vehicle** → **Lights**” to turn Light Saber Mode on or off.

i Tips

Switching on Light Sword mode requires a second confirmation in the pop-up window.

Rear Marker Lights

In the touchscreen, go to “ → **Settings** → **Vehicle** → **Lights**” to turn the rear marker light on or off. When this function is enabled, the rear marker light will illuminate together with the position lights.

i Tips

Turning on the rear marker light requires a second confirmation in the pop-up window.



Light Signals System

The vehicle is equipped with a rich variety of scenario light signal systems. You can enable light signal according to your actual needs.

"Light Signal Settings"

In the touchscreen, go to “ → **Settings** → **Vehicle** → **Lights**” to configure light signal modes:

- Play Light Signal While Charging: When enabled, a charging light signal effect will be displayed outside the vehicle while it is charging.
- Say Hi Light Signal effect settings: The Say Hi Light Signal offers three effects, “**Smiley, Shuttle, and Heartbeat**”, which you can select according to your needs.
- Automatically play Say Hi when parked: When enabled, the Say Hi light signal will automatically play when Auto Hold is activated or the vehicle is shifted to P.

Tips

The Say Hi phrase will not be played while driving or when the turn signals, rear fog lights are on.

warning

Say Hi plays the headlights off, be aware of driving safety and comply with traffic regulations.

Set Play Light Signal when Locking/Unlocking

In the touchscreen, go to “ → **Settings** → **Vehicle** → **Lock/Unlock & Welcome**” to set Play Light Signal when Locking/Unlocking:

- Play Light Signal when Unlocking: When enabled, an unlocking light signal effect will be played outside the vehicle when it is unlocked.
- Play Light Signal when Locking: When enabled, a locking light signal effect will be played outside the vehicle when it is locked.
- Unlock Lighting Signal Effect Settings: The vehicle offers three lock/unlock lighting signal



effects, “**Growth, Surround, and Dynamic**”, which you can set according to your personal preference.

Intelligent High Beam (IHB)

IHB (Intelligent High Beam) can automatically switch between high and low beam headlights based on information such as vehicles ahead and ambient lighting, in order to avoid disturbing other road users.

Status Indicator Light



IHB is on and the high beam headlights are off.



IHB is on and the high beam headlights are on.



IHB has a malfunction.

Touchscreen Settings

In the touchscreen, go to “ → **Settings** → **Vehicle** → **Lights**” to turn Intelligent High Beam on or off.

Using IHB

IHB is activated when all of the following conditions are met, and the vehicle will automatically switch between high and low beam headlights according to the road environment:

- The lighting switch in the touchscreen is set to Auto or Low Beam Headlights.
- The vehicle speed is above 30 km/h.

Tips

If the vehicle speed is less than 15 km/h when IHB is activated, IHB will deactivate.

warning

IHB may not work in the following scenarios:

- Camera restricted.



Accompany Me Home

When the Accompany Me Home function is enabled, in nighttime or low-light conditions, the vehicle will automatically turn on the low beams after you lock the vehicle to illuminate the road ahead.

In the touchscreen, go to “ → **Settings** → **Vehicle** → **Lock/Unlock & Welcome**” to turn the Accompany Me Home function on or off and set the headlamp delay-off time.

Light Welcome

Light-Carpet Welcome

When the Light-Carpet Welcome function is enabled, the welcome light-carpet will automatically illuminate when the vehicle is unlocked or a sliding door is opened, creating a welcoming ceremony effect.

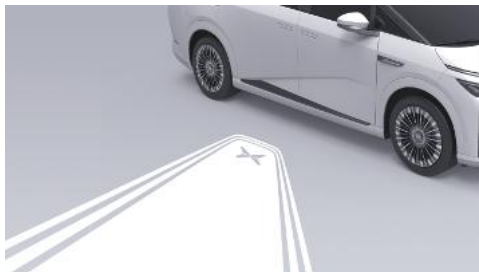

In the touchscreen, go to “ → **Settings** → **Vehicle** → **Lock/Unlock & Welcome**” to turn “**Light-Carpet Welcome**” on or off.

Light Welcome

When the Light Welcome function is enabled, the system will automatically turn on the position lights, front headlamps, and light-carpet as you approach the vehicle, creating a welcoming ceremony effect.



In the touchscreen, go to “ → **Settings** → **Vehicle** → **Lock/Unlock & Welcome**” to turn “**Light Welcome**” on or off.

Interior Lights

Ambient Lighting

The vehicle is equipped with ambient lighting, which can change color with the rhythm of the music to add warmth to your journey home at night.

Touchscreen Settings

In the touchscreen, go to “ → **Settings** → **Vehicle** → **Ambient Lighting**” to configure the ambient lighting.

Brightness Adjustment and Color Selection

After the ambient lighting is turned on, you can manually adjust the ambient lighting brightness. Depending on the mode, you can choose Theme Color, Fixed Color, or Cycle Color options for the ambient lighting color.

Under the Fixed Color option, you can individually select the main area color, secondary area color, and floor color, or select one color to synchronize across the entire vehicle.

Ambient Lighting Modes

The ambient lighting has four mode settings: Constant Brightness, Smooth Breathing, Follow Speed, and Music Rhythm, which can be selected in the ambient lighting control interface.

Reading Lights

When the interior light is insufficient, the interior reading lights provide appropriate illumination for occupants without affecting the driver's normal driving.

You can turn the reading lights on/off using any of the following methods:

- Turn the reading lights on/off using the reading light switch.
- Turn the reading lights on/off via the touchscreen.



- Turn the reading lights on/off via the rear entertainment screen.
- Turn the reading lights on/off using voice commands.

Reading Light Switches

The front-row reading lights are integrated in the front overhead console. Touch the lens to turn the reading light on, and touch it again to turn it off.



Touch the lens of the second-row/third-row reading light on the corresponding side to turn the light on, and touch it again to turn it off.



6

The second row is also equipped with overhead reading lights that support touch on/off and angle adjustment:

- Touch the lens of the reading light on the corresponding side to turn the light on, and touch it again to turn it off.
- Rotate the reading light to adjust its angle.

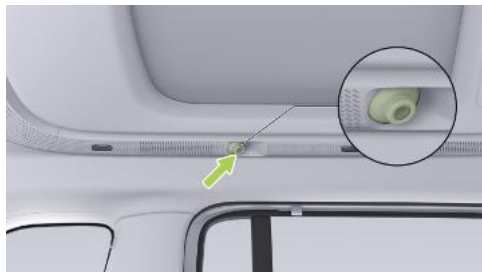

Touchscreen Settings

In the touchscreen “ → **Settings** → **Vehicle** → **Lights**” screen, you can make the following settings for the reading lights:

- Tap “**Reading Lights**” to turn the reading lights on/off.
- Select the options under “**Reading Light Brightness Adjustment**” to adjust the reading light brightness.

- Slide the options under “**Overhead Reading Light Color Temperature**” to adjust the overhead reading light color temperature.

Tips

The reading light automatically illuminates when the door is opened, and the reading light automatically extinguishes when the door is closed.

Rear Entertainment Screen Settings

On the rear screen, tap  to open the quick panel, then tap “**Overhead Reading Lights**” to open the overhead reading light settings screen:

- Tap “**Left Overhead Reading Lights/Right Overhead Reading Lights**” to turn the overhead reading light on the corresponding side on/off.
- Select the options under “**Brightness Adjustment**” to adjust the overhead reading light brightness.



- Slide the options under “**Color Temperature**” to adjust the overhead reading light color temperature.

Wiper Operation

Manual Wiper

You can turn the wiper function on or off by rotating the wiper switch.



- ≡: Wipers operate continuously at high speed.
- —: Wipers operate continuously at low speed.

- **A**: Turns on the automatic wiper function.
- **O**: Turns the wipers off.

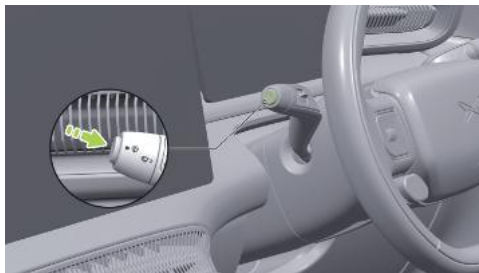

- **Mist**: Briefly press the washer switch and the wipers will wipe once.

Automatic Wiper

Rotate the front wiper switch to the “**A**” position to turn on the automatic wiper function. After activation, when the vehicle’s rain sensor detects rain, the system will turn on the wipers and adjust the wiping speed according to the set sensitivity.



Auto Wiper Sensitivity Adjustment

Adjustment using the sensitivity switch:

- Push the sensitivity switch up to increase auto wiper sensitivity.
- Push the sensitivity switch down to decrease auto wiper sensitivity.



Adjustment via the touchscreen:

- In the touchscreen “ → **Settings** → **Vehicle** → **Doors & Windows**” screen, you can set the auto wiper sensitivity to “**Low**,

Medium, High, or Very High” levels. The higher the level, the higher the wiper sensitivity.

caution

- Before operating the wipers, make sure that the front hood and the driver’s door are in the locked state.
- When washing the vehicle, turn off the automatic wiper function to avoid personal injury or damage to the wipers.
- Before using the wipers in severe weather conditions, make sure that the wiper blades are not frozen to or stuck to the windshield.
- If there are foreign objects (such as accumulated snow, leaves, etc.) on the wipers or windshield, park the vehicle in a safe area and then remove them.

Windshield Washing

Windshield washing uses washer fluid to remove dirt from the front windshield, preventing impairment of the driver’s vision and improving driving safety.



When the vehicle is low on windshield washer fluid, refill the washer fluid in a timely manner [See 467 page](#).

Press and hold the wiper washer switch to spray washer fluid while the wipers operate. After releasing the switch, the washer stops spraying, and the wipers continue wiping for a short time before stopping.

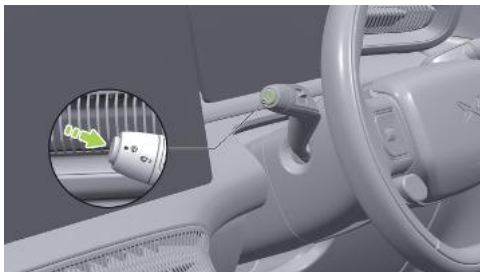

i Tips

- Do not use the window wash for too long each time, as this may damage the front washer motor.
- Do not operate the washer when the reservoir is low on washer fluid, as damage to the front washer motor may occur.

Replace Wiper Blades

Shift the vehicle to the P position and keep the wipers turned off. In the touchscreen “ → **Settings** → **Vehicle** → **Maintenance**” screen, you can turn the Wiper Maintenance Mode on or off. When this mode is turned on, the wiper arms move to the service position; when the mode is turned off, the wiper arms automatically return to their normal position.

Replacing the front wiper blades

1. In the touchscreen, turn on “**Wiper Maintenance Mode**”. The wiper arms will move to the service position.



2. Lift the wiper arm, press the side locking button, and pull out the wiper blade to remove it.



3. Install the new wiper blade onto the wiper arm by following the reverse steps. When you hear a “**Click**”, the blade is correctly installed.
4. Gently lower the wiper arm back onto the windshield.
5. Turn off Wiper Maintenance Mode.

caution

- Before replacing the wiper blades, Wiper Maintenance Mode must be activated with the front hood closed; otherwise, the vehicle may be damaged.
- Before removing the wiper blades, place a thick, soft towel between the wiper blade and the windshield to prevent accidental scratching of the windshield when removing the blade.
- When cleaning the glass or wiper blades, or when replacing the wiper blades, lift the wiper arm to raise the wiper. Do not pull directly on the wiper blade to avoid deforming the blade, which may cause abnormal wiping noise or reduced wiping performance.



Side Mirrors

Adjust Exterior Mirror Angle

1. In the touchscreen, tap  to enter the Control Center screen, then tap the “**Side Mirror Adjustment**” button to open the side mirror adjustment screen.

Tips

You can also bring up the exterior rearview mirror adjustment interface via the quick panel on the touchscreen or by using voice commands (for example, saying keywords such as “adjust exterior rearview mirror”).



2. After opening the side mirror adjustment screen in the touchscreen, you can adjust the side mirror angle using the scroll wheels and left/right buttons on both sides of the steering wheel.

warning

- Do not adjust the exterior mirrors while the vehicle is in motion to prevent accidents.
- Do not manually press the exterior mirrors to adjust the tilt angle.



- Do not make private modifications to the exterior mirrors.

Automatic Mirror Tilt-down in Reverse

In the touchscreen, tap  to enter the Control Center screen, then tap the “**Side Mirror Adjustment**” button. After opening the side mirror adjustment screen, you can turn the Automatic Mirror Tilt in Reverse function on or off.

When this function is enabled and the vehicle is in R (Reverse), the side mirrors will automatically tilt down to a certain angle to assist with reversing.

Tips

You can also use voice commands (for example, say “Turn on Mirror Tilt in Reverse” or “Turn off Mirror Tilt in Reverse”) to enable or disable the Automatic Mirror Tilt in Reverse function.

Adjusting the side mirror tilt angle

The side mirror tilt angle can be set manually as follows:

1. In the touchscreen, turn on the Automatic Mirror Tilt in Reverse function.
2. Press the brake pedal and shift the vehicle into R (Reverse).

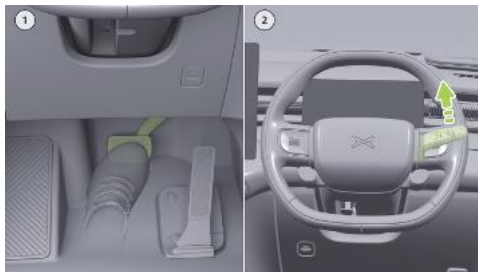

3. After the mirrors have finished tilting down automatically, tap  in the touchscreen to enter the Control Center screen, then tap



“Side Mirror Adjustment” to open the side mirror adjustment screen.

- Adjust the mirror angle using the steering wheel scroll wheel and the left/right buttons.



- After adjustment is complete, shift the vehicle out of R (Reverse) to save the setting.

warning

Depress the brake pedal all the way during adjustment to avoid the risk of reversing the vehicle.

Exterior Mirror Extend&Fold

You can extend/fold the side mirrors in any of the following ways:

- Use voice commands to extend/fold the side mirrors, for example by saying keywords such as “extend mirrors” or “fold mirrors.”
- In the touchscreen, tap  to enter the Control Center screen to extend/fold the side mirrors.

Exterior Mirror Reset

Due to accidental impact or manual force, the side mirrors may be pushed into a forward-folded or rear-folded position. Restore them to the normal position using the following method.

- In the touchscreen, tap  to enter the Control Center screen and extend the side mirrors. Wait for the side mirrors to complete their movement.
- Manually push the side mirrors to the normal position.

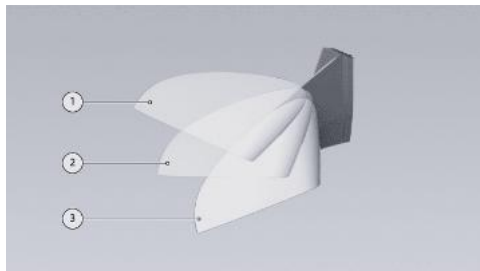

1. Forward-folded position
2. Normal position
3. Rear-folded position

i Tips

Before manually resetting, check the folding surface for ice, snow, or other foreign objects. Remove the foreign objects before resetting, otherwise the folding structure of the exterior rearview mirror may be damaged.

Exterior Mirror Heating

Using the side mirror heating function can quickly remove fog or water droplets from the mirror glass, improve rear visibility, and enhance driving safety.

On the climate control screen, you can turn on rear defrost and side mirror heating with a single tap.

i Tips

You can also use voice commands to turn the rear defrost and side mirror heating functions on or off.

! caution

Do not touch the exterior rearview mirrors with your hands when the heating function is on to avoid burns.



Exterior Mirror Memory

After adjusting the side mirror glass angle, the setting will be automatically saved to the current driving profile.

Streaming Rearview Mirror

Function Overview

The streaming rearview mirror functions both as a conventional mirror and as a display screen. When switched to streaming mode, it displays the rear view captured by the camera at the back of the vehicle, providing good visibility during daytime, nighttime, and in adverse weather such as rain, snow, or frost.



1. Rear light sensor
2. Streaming rearview mirror mode switch

caution

To ensure proper brightness adjustment:

- Do not obscure or cover the rear photoconductor unit.
- Keep the rear photoconductor unit clean.

The streaming rearview mirror camera is located above the rear license plate panel. Do not block

Interior Functions



or cover the camera. Keep the camera clean and promptly remove any dirt.



Turn Streaming Rearview Mirror On&Off

1. In the touchscreen, tap  to enter the Control Center screen, then tap the **“Streaming Rearview Mirror”** button to open the streaming rearview mirror screen.
2. Turn the streaming rearview mirror function on or off.

Press the switch to turn on the streaming display function. Press the switch again to switch to conventional mirror mode.



Tips

- You can also use voice commands to turn the streaming display function on or off.
- When the trunk is opened, the streaming display function will turn off automatically.
- When the streaming display function is off, turning on the rear entertainment screen will



automatically turn on the streaming display function.

Adjust Streaming Display View

After the streaming rearview mirror adjustment screen is displayed in the touchscreen, you can adjust the streaming display field of view using the steering wheel scroll wheel.

- The left scroll wheel can zoom in or out on the streaming media display area.



- The right scroll wheel can adjust the vertical position of the field of view.



You can also enable or disable the **Automatic visibility adjustment while reversing** and **Automatic visibility adjustment at high speeds** functions on the streaming rearview mirror adjustment screen in the touchscreen:

- Automatic visibility adjustment while reversing: When the vehicle is in R gear, the system automatically adjusts the streaming media display area.
- Automatic visibility adjustment at high speeds: When the vehicle is in D gear and the speed

Interior Functions



is above 80 km/h, the system automatically adjusts the streaming media display area.

Adjusting streaming media display brightness

On the streaming rearview mirror adjustment screen in the touchscreen, select **“Dark, Dim, Medium, Bright, Brighter”** under **“Brightness Preference”**. Within each brightness level, the system will automatically adjust within a certain range according to the ambient light.

Adjusting Interior Rearview Mirror Angle



1. Adjust the driver's seat to a suitable position.
2. Hold the interior rearview mirror and adjust it up/down and left/right until you can clearly see the area behind the vehicle.

Tips

When adjusting the rearview mirror lens angle, it is recommended to use both hands.

Usage Notes

warning

The streaming interior rear view mirror is an aid only and is not a substitute for the driver's judgment of the outside world. Do not rely solely on the internal mirrors when driving or parking, in all circumstances the driver is responsible for the safety of the vehicle and is always aware of the surroundings.

Do not install anything around the interior rear view mirror to prevent the driver from observing the road.



Do not adjust the streaming interior mirror while the vehicle is in motion, as injury, death, and property damage may occur.

Do not use the streaming interior mirror in the following scenarios:

- Camera restricted.
- Poor weather conditions (e.g. heavy rain, heavy snow, heavy fog, etc.).

i Tips

- At night or in dim environments such as tunnels, the lights of vehicles behind shown on the display may exhibit some scattering and halos, causing slight obstruction in the field of view. The driver must pay attention and drive with caution.
- If the streaming display image shows missing pixels or cannot display properly in part or in whole, switch to using the conventional mirrored interior rearview mirror and promptly contact an XPENG service center for inspection and repair.

- When washing the vehicle with a high-pressure water gun, do not spray the cameras, as water ingress may cause camera damage and system malfunction.
- If the rear of the vehicle is damaged, the camera may not be able to capture an accurate view. In this case, it is recommended to switch to using the conventional mirrored interior rearview mirror.
- Before driving, check the position of the interior rearview mirror and adjust it if necessary.

Wireless Charging

Front Row Wireless Charging

The first-row wireless charging area is located at the front end of the front center armrest. The maximum wireless charging power for the phone is 50 W. When charging, place the phone with the screen facing up and slide it along the guide rail to the bottom of the charging area. This helps

Interior Functions



the phone detect charging and improves heat dissipation. When charging, the touchscreen will show the icon “🔋”.



Second Row Wireless Charging

The second-row wireless charging area is located on the outer armrest of the seat. The maximum wireless charging power for the phone is 50 W. When charging, place the phone with the screen facing up and slide it along the guide rail to the bottom of the charging area.



Touchscreen Settings

In the touchscreen, in the “📱”
→**Settings**→**Energy**→**Power Supply**” screen, you can turn the first- and second-row wireless charging function on or off.

i Tips

You can also use voice commands to turn the wireless charging function on or off.



caution

Some phones do not have wireless charging capabilities. Placing the phone on a wireless charging pad may cause the screen to flicker or bounce. If necessary, it is recommended to turn off the wireless charging switch on the central control screen.

Cell Phone Left Behind Reminder

In the touchscreen, in the “ → **Settings** → **General** → **Safety and Privacy**” screen, you can turn the Cell Phone Left Behind Reminder on or off. After this function is enabled, when the phone is charging wirelessly and a door is opened, a voice prompt will remind you to take your phone with you when leaving the vehicle.

Notes

Wireless charging will stop in the following situations:

- If the phone is placed at the very top of the charging area, charging may be interrupted or the phone may not be detected.

warning

- To avoid interference between medical or implantable electronic devices and the wireless charging system for mobile phones, personnel using medical or implantable electronic devices should maintain an appropriate distance from the wireless charging area of the mobile phone.
- Wireless phone charging function has a heating effect on metal, please make sure that there are no metal objects in the back of the phone and in the charging area before starting charging, this may cause metal objects to be heated or damaged, or even cause safety incidents. Metal foreign objects here refer to other objects with metal components, including but not limited to chips, magnetic cards, etc.



- For phones that do not have wireless charging, it is recommended to manually tap the center screen setting to turn off wireless charging in the corresponding area to avoid affecting the normal use of the phone.
 - For mobile phones with 50W power wireless fast charging, the phone must be placed along the limit bar at the bottom of the charging area, and the bottom of the phone should be fully covered to avoid overheating problems.
 - The wireless charging cooling fan outlet is located at the lower end of the wireless charging, be aware that foreign objects and liquids enter the outlet and affect the operation of the fan.
 - Do not spill water in the wireless charging area to prevent damage to the electronics when water enters the wireless charging module.
 - External wireless charging coils can cause accidents and should be used with caution.
- Do not place your phone in the vehicle to charge when the driver is not in the vehicle, as this may cause a safety hazard.
 - Do not place heavy objects in the charging area to avoid damaging the wireless charging module.
 - If the wireless charging function does not work or does not work properly, stop using it and contact the Xpeng Automobile Service Center for service.
 - It is normal for the phone to get warm after a long charge. Do not leave the charging device in the charging area after it is fully charged, as this may cause overheating problems.
 - Do not use a metallic phone case, such as a phone case that supports magnetic charging (MagSafe).



Hot and Cold Integrated Powered Refrigerator

Function Overview

The vehicle is equipped with an electrically operated hot-and-cold refrigerator, which provides refrigerated and frozen storage for drinks and food, enhancing convenience for long-distance trips and everyday use.

You can control the onboard refrigerator in the following ways:

- Using the refrigerator control panel
- Using the touchscreen
- Using the mobile App

i Tips

It only supports turning the refrigerator on/off for either cooling or heating and has a timer function.

- Using voice commands

Operation

Onboard refrigerator control panel



1. Turn the refrigerator power on or off.

i Tips

Once the function is enabled, the refrigerator will retain its settings from the last time it was powered off.

2. Cooling mode: Temperature setting range 0°C–20°C.
3. Decrease the refrigerator temperature.



4. Display the refrigerator temperature.
5. Increase the refrigerator temperature.
6. Heating mode: Temperature setting range 30°C–50°C.
7. Open or close the refrigerator door.

caution

- If the refrigerator door is left open for an extended period of time, the central control screen and XiaoP voice assistant will issue a reminder.
- The refrigerator door is electrically operated; do not force it to open or close manually, as this may cause damage.
- Do not adjust the second-row seats when the refrigerator door is open, as this may cause the seats to collide with the refrigerator and damage the hardware.

Touchscreen settings screen

In the touchscreen, go to the “ → **Settings** → **Device**

Connection → **Devices** → **Refrigerator**” screen to set various functions of the onboard refrigerator.

1. Turn the refrigerator power on or off.
2. Open or close the refrigerator door.
3. Heating mode: Temperature setting range 30°C–50°C.
4. Cooling mode: Temperature setting range 0°C–20°C.
5. Adjust the refrigerator temperature.
6. Set the heat-preservation time after the vehicle is locked.

caution

When there are children in the vehicle, it is recommended to turn on the refrigerator child lock to prevent children from operating the refrigerator and changing its settings.



Mobile App settings screen



On the “XPENG→Refrigerator” screen in the mobile App, you can set commonly used functions of the onboard refrigerator.

1. Adjust the refrigerator temperature.
2. Heating mode: Temperature setting range 30°C–50°C.
3. Cooling mode: Temperature setting range 0°C–20°C.
4. Turn the refrigerator power on or off.

Onboard Power Outlet

Front Port of Center Armrest Box



1. USB media source port: Used for driving recorder USB flash drive data transfer, and for connecting a microphone, game controller, etc.
2. Type-C power port: Used for driving recorder USB flash drive data transfer and charging electronic devices. Supports standard charging protocols, with a maximum power output of 60 W.

Interior Functions



- 12 V power outlet: Maximum supported power is 180 W.

caution

Do not use the USB media source interface for charging, as this may cause the central control screen to restart or go black.

Second Row Inner Seat Port

Type-C power outlet: Maximum supported power is 60 W.



warning

Unauthorized modification of the Type-C interface is prohibited.

Third Row Side Trim Port

There is one Type-C power outlet on each side trim panel in the third row, each supporting up to 15 W.





warning

Unauthorized modification of the Type-C interface is prohibited.

Trunk 12V Power Port



12 V power outlet: Maximum supported power is 180 W.

"Delayed Power Off "

When the delayed power-off function is enabled, after the vehicle power is turned off, the 12 V

power outlet in the trunk will remain powered for the preset duration before shutting down.

You can turn the delayed power-off function on or off and set its duration via the touchscreen or the mobile App.

- **Touchscreen* (If applicable)** : In the touchscreen, in the “  → **Settings** → **Charging and Discharging** → **Power Supply** ” screen, you can turn the delayed power-off function on or off. Tap > to set the delayed power-off function.

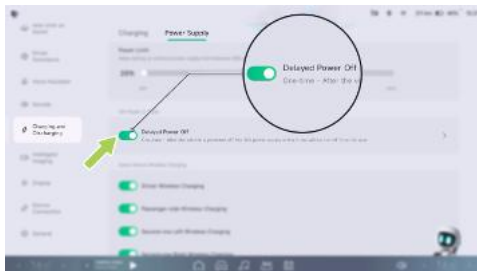

Interior Functions



- **Mobile App:** In the XPENG mobile App, on the “XPENG” screen, tap the “In-vehicle Power” icon to enter the delayed power-off settings screen.



After lowering the sun visor, remove the end of the sun visor near the interior rearview mirror from its bracket and pivot the visor toward the side window to block sunlight entering through the side window glass.

6

Interior Equipment

Sun Visor

Lower the sun visor in the direction of the arrow to block sunlight entering through the windshield.

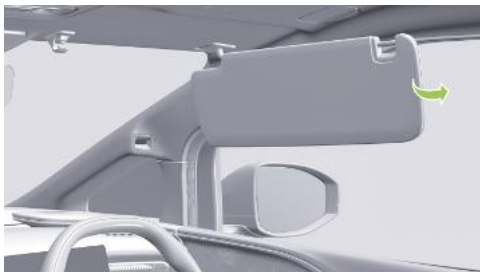

warning

A folded-down sun visor may obstruct your view. If you no longer need to use the sun visor, be sure to retract it into its bracket.

Vanity Mirror

Both the driver and front passenger sun visors are equipped with vanity mirrors, which you can use to adjust your appearance.

- Position the sun visor as needed, then flip down the vanity mirror cover (or magnetically

attach the cover to the back of the sun visor) to turn on the vanity mirror light.

- After closing the vanity mirror cover, the vanity mirror light will turn off; then fold the sun visor back.



Tips

- When the vanity mirror is not in use, please close the vanity mirror cover.
- Even if the vanity mirror cover is not closed (for example, the cover is magnetically attached to the back of the sun visor), the

Interior Functions



vanity mirror light will automatically turn off when the sun visor is moved to its non-use position.

warning

Do not use a makeup mirror while driving.

Cup Holder

The vehicle is equipped with multiple cup holders for placing beverages or cups.

Front passenger instrument panel cup holders

Two cup holders are provided on the front passenger instrument panel.

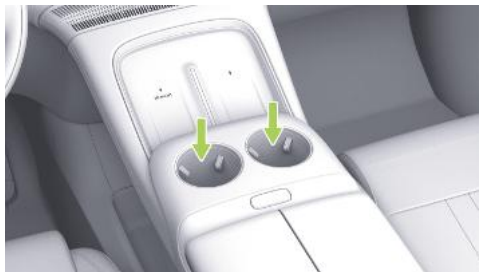

Sliding door cup holders

Each sliding door is equipped with one cup holder.



Second-row seat armrest cup holders

Each second-row seat armrest is equipped with one cup holder; push the cup holder to open and use it.



Third-row cup holders

The third-row cup holders are located on the armrests on both sides.



caution

When using a cup holder, avoid placing small items or other miscellaneous objects on it to prevent the cup holder from getting stuck.

warning

Do not place open beverages or water cups on the cup holder while the vehicle is in motion. This is to prevent hot drinks from splashing out and scalding passengers or damaging the vehicle and its electrical equipment.

Storage Compartments

The vehicle is equipped with multiple convenient storage compartments for storing everyday items.

Glasses holder

Press the glasses holder lid to open the glasses holder.

To close it, push the glasses holder lid upward until you hear a “click” indicating it is latched.





Glove box

Press the glove box release to open the glove box.

To close it, push the glove box upward until it is fully closed.

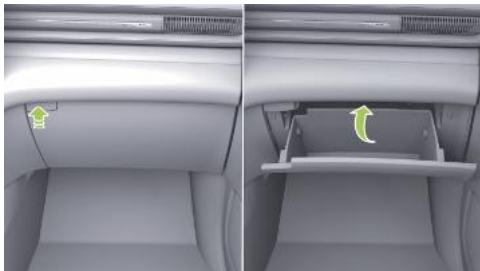

caution

When not in use, make sure the glove box is closed. Otherwise, in the event of a collision or emergency braking, items in the glove box may be thrown out and cause injury.

Center armrest box

Press the center armrest box release to open the center armrest box.

To close it, push both sides of the armrest box lids inward until they are fully closed.

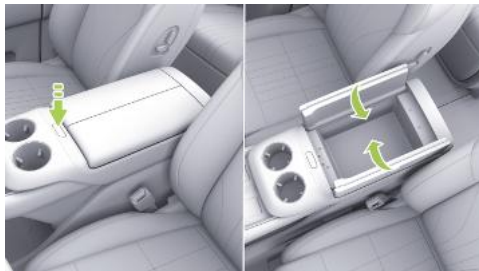

caution

Do not oversize the item or the armrest will not close. An open armrest may obstruct the driver.

Interior Functions



Through-type storage compartment

The through-type storage compartment is located below the front of the front passenger instrument panel.



Front door storage pockets

There are storage pockets at the bottom of the front doors for placing drinks or storing items.



caution

- Do not block the emergency door unlocking mechanism when placing objects in the door storage space, as this will not work in an emergency.
- Do not place glasses, lighters or spray tanks in the storage device to avoid damage caused by jaggling.



Front/second-row seatback magazine pockets

Magazine pockets are provided at the lower part of the front and second-row seatbacks for storing receipts, magazines, and similar items.



Second-row phone storage slot

The second-row seats are equipped with a phone storage slot for placing mobile phones.



Hook

Hooks are provided on the interior C-pillars for hanging clothing and other items.



⚠ caution

Do not hang items greater than 3 kg to avoid damaging the hook.

⚠ warning

Do not hang any hard objects (e.g. hangers, fruits, glass bottles, etc.) to prevent injury if the side curtain is detonated.



Vehicle Power On&Off

Powering On

When you unlock the vehicle from outside and open a door, the vehicle will automatically power on. At this time, the touchscreen will turn on, and you can use comfort features such as the air conditioner and multimedia system.

When the vehicle is powered off (that is, the touchscreen is off), if the NFC card key, remote key, or phone Bluetooth key is inside the vehicle, pressing the brake pedal will power on the vehicle.

Starting the Vehicle

The vehicle is equipped with a keyless entry system. As long as you carry a valid key with you and enter the vehicle, you can operate and start the vehicle.

After making sure the vehicle is in P, press the brake pedal and shift to D or R to start driving. The vehicle then enters the READY state, and

the indicator light on the instrument panel **READY** will illuminate.



caution

Before starting the vehicle, properly adjust the seat, steering wheel, and interior and exterior mirrors, and make sure you can operate the brake pedal and accelerator pedal normally.

Power off

If there is no one in the driver's seat and the vehicle is locked from outside, the vehicle will



automatically power off and the touchscreen will gradually turn off.

Automatic power-off after 1 hour

In the touchscreen “ → **General** → **Safety and Privacy**” screen, you can turn the “**Power Off Automatically**” function on or off.

When this function is enabled, if the system detects that no one is inside the vehicle and there has been no operation for 1 hour, the vehicle will automatically power off.

Emergency Power Off

Emergency power-off via the touchscreen

If the vehicle is stationary and an emergency power shutoff is required, go to the touchscreen “ → **Vehicle**” screen and tap “**Turn off the vehicle electric power**” to shut down the high-voltage power supply and power off the vehicle immediately.

Emergency power-off via the SOS switch

If the vehicle is stationary and an emergency power shutoff is required, press and hold the SOS switch for 5 seconds to power off the vehicle immediately.



caution

We recommend using this function when the vehicle cannot be powered off.



Shifting Operation

Shifting Gears

The vehicle uses a column-mounted electronic gear selector with four positions: Park (P), Reverse (R), Neutral (N), and Drive (D).



You can change the vehicle gear position as follows:

- **Reverse (R):** Press the brake pedal and push the gear selector upward to the top position.

The vehicle will shift into R and the reverse lights will turn on.

- **Neutral (N):** Press the brake pedal, then gently push the gear selector up or down and hold it for about 1 second, until N is shown in the gear position display area on the instrument panel. The gear position will switch to Neutral (N), allowing temporary stops.
- **Drive (D):** Press the brake pedal and push the gear selector down to the lowest position to shift to Drive (D). The vehicle will move forward.

P: Park

When the vehicle is stationary, press the P button to its limit position to shift into Park.



When the vehicle is in Park (P), you must press the brake pedal before you can push the gear selector up or down to change gears.

i Tips

With the vehicle in D or R and vehicle speed less than 3 km/h, open the main drive door without seat belt, brake and accelerator pedals applied, The vehicle will automatically switch to P.

! caution

- Before leaving the vehicle or on a ramp, make sure the vehicle is in P to prevent the vehicle from moving without cause.
- When the vehicle is at high speed, pressing and holding the P key will trigger the emergency braking function.
- If you are unable to shift gears properly, you should contact the Xpeng Automobile Service Center for service.

Shift Indicator Information

When the gear position is changed, the instrument panel displays the current gear position.



Tips

- After shifting gears, always check the gear position on the instrument panel. If the displayed gear position does not match your intended selection, shift again and confirm the gear position once more.
- If the conditions for shifting are not met, a message will appear on the instrument panel. Follow the instructions shown and shift only after the conditions are satisfied.

P Gear Shortcut

In the touchscreen, in the “ →**Vehicle**→**Doors & Windows**” screen, you can turn the “**P Gear Shortcut**” function on or off. When this function is enabled, commonly used control options are displayed in the lower-left corner of the touchscreen when the gear is shifted to Park (P), making one-touch operation more convenient.

Tips

You can also use voice commands to turn the P Gear Shortcut function on or off.

Driving Mode

Switching Driving Modes

In the touchscreen, in the “ →**Vehicle**→**Drive Modes**” screen, you can switch the drive mode.

- **Eco:** Slower power response, which can extend driving range.



- **Comfort:** Smooth power response for a more comfortable ride experience.
- **Sport:** Quick power response for an enhanced, dynamic driving experience.
- **Custom:** Allows you to freely adjust multiple function parameters for a personalized driving experience.

Tips

You can also use voice commands to switch the driving mode.

Snow Mode

Snow Mode is suitable for roads covered with ice and snow, and also for slippery surfaces such as muddy or grassy roads. When this mode is enabled, it improves vehicle driving stability and reduces wheel slip.

In the touchscreen, in the “ → **Vehicle** → **Drive Modes** → **Special Scenario Assist**” screen, you can turn Snow Mode on or off.

Tips

- You can also turn Snow Mode on or off using voice commands.
- Please turn off Snow Mode after the vehicle has passed the special road surface.
- When this mode is enabled, the individual functions within Drive Modes cannot be adjusted. After exiting this mode, the drive mode returns to the state it was in before activation.
- The next time the vehicle is powered on, Snow Mode is turned off by default.

caution

- Snow Mode can improve vehicle driving stability, but you must still drive with caution and avoid rapid acceleration or rapid deceleration.
- Pay close attention to the area around the vehicle; otherwise, vehicle damage may occur.



Wet Mode

Wet Mode is suitable for roads with standing water, slippery asphalt roads, underground parking garages, and similar surfaces. When the mode is enabled, it improves vehicle driving stability and reduces wheel slip.

In the touchscreen, in the “ → **Vehicle** → **Drive Modes** → **Special Scenario Assist**” screen, you can turn Wet Mode on or off.

Tips

- You can also turn Wet Mode on or off using voice commands.
- Please turn off Wet Mode after the vehicle has passed the special road surface.
- When this mode is enabled, the individual functions within Drive Modes cannot be adjusted. After exiting this mode, the drive mode returns to the state it was in before activation.

- The next time the vehicle is powered on, Wet Mode is turned off by default.

caution

- Wet Mode can improve vehicle driving stability, but you must still drive with caution and avoid rapid acceleration or rapid deceleration.
- Pay close attention to the area around the vehicle; otherwise, vehicle damage may occur.

Super ECO Mode*(If applicable)

Function Overview

When the vehicle is in a low state of charge, you can enable Super ECO Mode. By turning off or disabling non-essential driving functions, this reduces overall vehicle energy consumption and extends driving range.



In the touchscreen, in the “→**Vehicle**→**Drive Modes**” screen, you can turn Super ECO Mode on or off.

warning

It takes some time to enable or disable Super ECO Mode. To ensure safety, avoid changing gears as much as possible during this process.

XPEDAL Regeneration

Regeneration Overview

When the vehicle is braking or coasting, the regeneration system starts to operate, converting kinetic energy into electrical energy and storing it in the high-voltage battery, thereby extending driving range.

Switching Regeneration Levels

In the touchscreen, in the “→**Vehicle**→**Drive Modes**” screen, you can set the level of regeneration.

- Off: Regeneration is turned off.
- Low: When you release the accelerator pedal, vehicle speed decreases slowly, providing better ride comfort.
- Medium: Balances deceleration and comfort, recommended for everyday use.
- High: When you release the accelerator pedal, vehicle speed decreases quickly, and the deceleration is more noticeable.

Tips

- You can also use voice commands to change the regeneration level.
- When regeneration causes a significant reduction in vehicle speed, the brake lights will automatically illuminate to alert vehicles behind that your vehicle is decelerating.
- The amount of regeneration depends on factors such as the current traction battery status, the selected Regeneration level, and the vehicle speed.



- A slight braking feel and motor noise during vehicle deceleration are normal conditions.

Stop Mode

In the touchscreen, in the “→**Vehicle**→**Drive Modes**” screen, you can turn the “**Stop Mode**” function on or off.

When this function is enabled and the vehicle is moving forward in Drive (D), the vehicle will gradually slow down to a stop after you release the accelerator pedal.

Tips

Any of the following conditions can cause the Stop mode to not function properly. At this point, the vehicle should be stopped by actively depressing the brake pedal.

- Shift into non-forward gear (D).
- Remove or remove the host drive seat belt.
- The AUTOHOLD function is faulty or inoperative.

warning

Stop mode is only an auxiliary function and cannot completely replace the brake pedal. During driving, if you judge that the braking distance is insufficient or encounter an emergency, you should immediately press the brake pedal to achieve braking.

Power Steering

Switching Power Steering

You can set the steering assist mode directly by using voice commands (for example, by saying “**Hello XPENG, set Power Steering mode to Light.**”) or via the touchscreen on the “→**Vehicle**→**Drive Modes**” screen.

- **Light:** The vehicle provides greater steering assistance, so less effort is required to turn the steering wheel.



- **Moderate:** The vehicle provides moderate power steering assistance and is the preferred choice for daily use.
- **Stable:** The vehicle provides relatively low power steering assistance, requiring greater steering torque from the driver.

i Tips

- When the vehicle is moving, switching to Power Assisted Steering mode requires a firm grip on the steering wheel to avoid sudden changes in feel affecting control of the vehicle.
- The following scenarios do not support switching between steering assist modes for safety reasons:
 - When the driver is making an intense steering;
 - Vehicle speed greater than 150 km/h;
 - The vehicle is in Assisted Driving mode.

Rear-Wheel Steering

Function Overview

The vehicle's rear-wheel steering supports a maximum steering angle of $\pm 5^\circ$. At high speeds, the rear wheels steer in the same direction as the front wheels to improve steering precision and vehicle stability. At low and medium speeds, the rear wheels steer in the opposite direction to the front wheels to enhance maneuverability and achieve a smaller turning radius, making parking or driving in urban conditions easier to control.

i Tips

- If the vehicle is powered on but not moving, turning the steering wheel while stationary will not turn the rear wheels.
- After the vehicle is powered on and brought to a stop, with the gear in D/R, turning the steering wheel while stationary will cause the rear wheels to steer. Avoid excessive turning while stationary, as this may trigger the overheat protection.



- When the over-temperature protection is activated, the rear wheel steering will automatically return to center and the response will be paused. The vehicle can be driven normally, and control will be automatically restored after 6 minutes.
- The instrument will issue a warning when the over-temperature protection is triggered.

Air Suspension

Function Overview

The air suspension supports the following operations:



- Setting the height
- Setting the stiffness
- Smart Chassis
- Suspension Welcome
- Easy Loading

Suspension Height

The air suspension height adjustment range is -30 mm to 40 mm. While driving, the vehicle will intelligently adjust the suspension height based on the height set by the driver, combined with vehicle speed, driving mode, and other information.

Setting the height

You can set the suspension height using any of the following methods:

- In the touchscreen, in the “ → **Settings** → **Vehicle** → **Drive Mode**” screen, you can set the “**Suspension Height**”.
- In the touchscreen, tap the “ →  ” screen to set the “**Suspension Height**”.

Height levels	Suspension Height	Recommended usage scenarios
---------------	-------------------	-----------------------------



Very High	+40 mm	Poor unpaved roads such as rutted roads, gravel roads, and muddy roads
High	+20 mm	
Normal	0 mm	Everyday driving
Low	-15 mm	Road sections for high-speed driving such as elevated roads and expressways
Lowest, Welcome mode	-30 mm	When getting in or out of the vehicle

Tips

- If the suspension height is adjusted repeatedly in a short period, the system will enter a thermal protection state. You must wait for the system to cool down before further adjustments can be made.
- The suspension height can also be adjusted via voice commands.

Suspension Stiffness

At different suspension stiffness settings, the vehicle can provide different levels of ride comfort and cornering handling experience.

Setting the stiffness

You can set the suspension stiffness using any of the following methods:

- In the touchscreen, in the “ → **Settings** → **Vehicle** → **Drive Mode**” screen, you can set the suspension stiffness and choose to turn “**Smart Chassis**” on or off.



- In the touchscreen, tap the “ → ” screen to set “Suspension Stiffness” to “Comfort,” “Standard,” or “Sport.”

Tips

- In ECO driving mode, the suspension stiffness is set to the default "ECO" mode and cannot be changed manually.
- The suspension stiffness can also be adjusted via voice commands.
- When reducing body pitch during acceleration and deceleration and controlling body roll while steering, the air Suspension may emit a "click" sound. This is the normal operating noise of the dual-chamber air valve.

Smart Chassis

After the Smart Chassis function is turned on, it can detect and record the locations of bumps. When you drive the vehicle over these bumps, it adjusts the chassis state in advance to allow the vehicle to pass more comfortably.



After the Smart Chassis function is turned on, it can detect severe bumps ahead in advance, provide a warning, and remind you to slow down when passing over them. When you drive the vehicle over severe bumps, the system will intelligently adjust the chassis state in advance to allow the vehicle to pass more comfortably.



Turning Smart Chassis on/off

In the touchscreen, in the “ → **Settings** → **Vehicle** → **Drive Mode**” screen, you can turn “**Smart Chassis**” on or off.

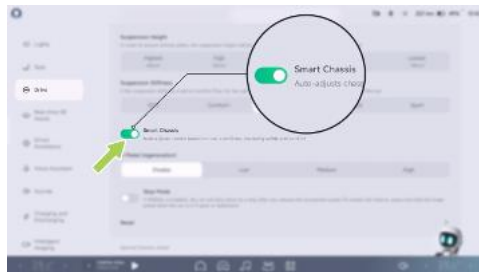

Suspension Welcome

When the Suspension Welcome function is turned on, the air suspension will automatically adjust the suspension height when you get in or out of the vehicle to make entry and exit easier.

Turning Suspension Welcome on/off

In the touchscreen, in the “ → **Settings** → **Vehicle** → **Lock/Unlock & Welcome**” screen, you can turn “**Suspension Welcome**” on or off.



caution

When the suspension approach is switched on, the suspension will automatically lower when parked. Due to the road conditions, lowering the suspension may cause the vehicle's underside to knock on the doors, causing body wear. Be aware of the parking environment to avoid vehicle damage.



Easy Loading

Auto Easy Loading

In the CID, in the “ → **Settings** → **Vehicle** → **Doors & Windows**” screen, you can turn “**Auto Easy Loading**” on or off. When this function is turned on, opening the trunk will automatically lower the suspension to the minimum height.

Manually turning Easy Loading on/off

You can manually turn the Easy Loading function on or off using the Easy Loading switch in the trunk.

- Press  to turn on the Easy Loading function; the suspension will lower to the minimum height.
- Press  to turn off the Easy Loading function; the suspension will return to its previous height.





Usage Notes

- When lifting the vehicle, the Suspension Maintenance Mode must be turned on. When towing the vehicle, the Rescue Mode must be



turned on. Otherwise, the air suspension may be damaged.

- For repairs involving removal or installation of the air suspension, you must have the work performed at an XPENG Service Center; otherwise, the air suspension may be damaged.
- If the  and/or  indicator lights on the instrument panel illuminate, do not continue driving. Park the vehicle in a safe location and contact an XPENG Service Center for inspection and repair; otherwise, the air suspension may be damaged.
- After the vehicle is parked for a long period, the suspension height may drop to some extent. This is normal. The suspension will automatically detect the height and refill air.
- Before parking the vehicle for a long period, turn off the Suspension Welcome function and adjust the suspension height to Normal or higher. Also, do not disconnect the battery, otherwise the suspension air-refill function will be affected and vehicle damage may result.

In the touchscreen, in the “ → **Settings** → **Vehicle** → **Maintenance**” screen, you can turn “**Suspension Maintenance Mode**” on or off.

High-Speed Tire Blowout Stability Control*(If applicable)

Introduction

The High-Speed Tire Blowout Stability Control function applies when the vehicle is traveling at high speed and a single tire blows out, or both the front and rear tires on the same side blow out simultaneously.

If a tire blows out while the vehicle is traveling at high speed, the system will quickly respond to changes in vehicle attitude, automatically turn on the hazard warning lights, and reduce the vehicle speed to a safe speed to help the driver keep the vehicle stable and to prompt pulling over and stopping safely at the roadside.



Operating conditions for High-Speed Tire Blowout Stability Control:

- All vehicle components are operating normally.
- While the vehicle is traveling in a straight line, the maximum speed must not exceed 150 km/h.
- While the vehicle is traveling through a curve, the maximum speed must not exceed 80 km/h.

Operation

1. When the vehicle is being driven manually, a single tire blowout or simultaneous blowout of the front and rear tires on the same side will trigger the High-Speed Tire Blowout Stability Control function. The system will automatically turn on the hazard warning lights and automatically reduce the vehicle speed to a safe speed. The instrument panel and CID will indicate the specific tire blowout location and provide a voice prompt. At the same time, the instrument panel, CID, and HUD will display a text message.
 - If a blowout occurs when the vehicle speed is above 60 km/h, the system will automatically reduce the speed to 60 km/h.
 - If a blowout occurs when the vehicle speed is below 60 km/h, the system will automatically reduce the speed to 25 km/h.
2. Hold the steering wheel firmly. After the vehicle speed has been reduced to a safe speed, the instrument panel, CID, and HUD will provide text and voice prompts reminding you to pull over and park safely at the roadside. After stopping, shift the vehicle into P.
3. After checking the surroundings and confirming there are no risks, all occupants should move from inside the vehicle to a safe location outside the vehicle. Place a warning triangular behind the vehicle as required by regulations to help prevent secondary accidents, and contact XPENG to request roadside assistance.



i Tips

- When the vehicle's speed drops to a safe speed after a tire blow, the vehicle will no longer be able to accelerate beyond that safe speed. To remove the safe speed limit, the vehicle can be powered down and then powered back up before the restriction can be lifted.
- The hazard warning lamps will switch on automatically when the high speed flat tire stability control function is triggered. You can manually turn off the hazard warning lights after you have confirmed that the surrounding environment is not at risk.
- When high speed flat tire stability control is triggered, the steering wheel will become heavier and more effort will be required to turn the steering wheel to assist the driver in maintaining a steady vehicle before safely stopping. To return steering feel to the pre-blow condition, the vehicle can be powered down and then re-powered and restored.

Warnings, Limitations, and Notes

- High-Speed Blowout Stability Control is a driver assistance function. It cannot handle all traffic, weather, and road conditions, and it may not operate properly in all situations. Due to various influencing factors, this function may fail, the vehicle may behave in ways that do not meet expectations in certain situations, or its responses may not be timely.
- After a tire blowout, the driver must hold the steering wheel firmly and keep the vehicle under directional control. Do not make any sudden or excessive steering inputs, as doing so may cause loss of control.
- Always remain attentive while driving. You bear ultimate responsibility for driving safely and must comply with all applicable traffic laws and regulations.



Braking Operation

Electronic Parking Brake (EPB)

The Electronic Parking Brake (EPB) can apply braking force to the rear wheels to keep the vehicle stationary.



After the vehicle has come to a complete stop, press the P position switch to activate EPB. At this time, the (P) indicator light will be displayed on the instrument panel.

After closing the driver's door, press the brake pedal and move the shift lever up or down to shift from Park (P) to Reverse (R) or Drive (D); the EPB will be released automatically. The (P) indicator light will go out.

Engage/release the EPB via the touchscreen

In the touchscreen “→Settings→Vehicle→Drive Mode” screen, engage or release the EPB.

Tips

- When the vehicle is in Park (P), the EPB cannot be released by turning off the “**Electronic Parking Brake**”.
- The system will emit operating noise when the EPB is applied or released; this is normal.

caution

- If the vehicle does not operate/close the EPB correctly, contact your Xpeng Vehicle Service Centre for service immediately.



- The EPB may not be able to hold the vehicle stationary on excessive gradients, which require the brake pedal to be pressed to prevent drifting.
- Never drive the vehicle without the EPB off, as damage to the vehicle may result.

AUTOHOLD

Auto Hold can apply the brakes to all four wheels and keep the vehicle stationary in situations that require a short stop, such as waiting at a red light, so the driver does not need to keep the brake pedal pressed for a long time or frequently activate the electronic parking brake.

In the touchscreen, go to the “ → **Settings** → **Vehicle** → **Drive Mode**” screen to turn the **Auto Hold** function on or off.

After Auto Hold is turned on, when you press the brake pedal and the vehicle slows to a stop, the Auto Hold function is automatically activated

and the  indicator light will be shown on the instrument panel.

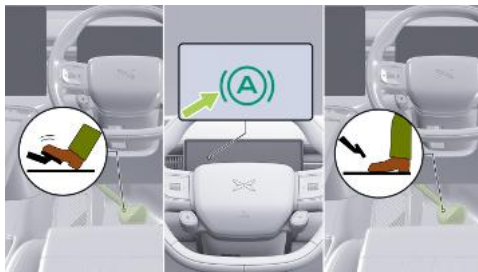

When you need to start driving, Auto Hold will be released as soon as you press the accelerator pedal.



When Auto Hold is active, if any of the following conditions occur, Auto Hold will automatically exit and the electronic parking brake will be applied:

- The driver unfastens the seat belt.
- The driver's door is opened.
- The Auto Hold maximum operating time is exceeded.
- The gear position is shifted to Park (P).

i Tips

Auto park is only active when the main door is closed, the seat belt is fastened and the gear is in D/R.

Brake Pedal Feel

In the touchscreen, go to the “ → **Settings** → **Vehicle** → **Drive Mode**” screen to adjust the Brake Pedal Feel.

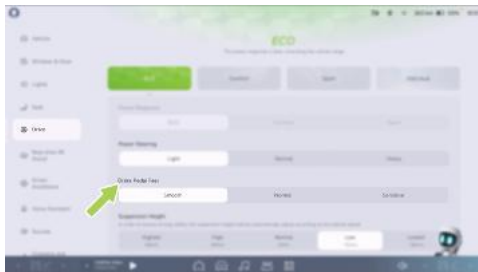

- **Mild:** Braking force builds up smoothly for a more comfortable ride.



- **Normal:** Braking force response is moderate, balancing driving enjoyment and ride comfort.
- **Sensitive:** Braking force responds quickly, providing more confident control.

Comfortable Braking

When braking, the vehicle may pitch forward (brake dive). The Comfortable Braking function can intelligently and smoothly adjust the braking force to reduce forward pitching, providing a more comfortable driving and riding experience for the driver and passengers.

In the touchscreen, go to the “ → **Settings** → **Vehicle** → **Drive Mode**” screen to turn the Comfortable Braking function on or off.

Electronic Stability Control (ESC)

The Electronic Stability Control (ESC) system can apply braking to one or more wheels and take other measures to effectively reduce the risk of skidding or spinning, helping maintain vehicle stability.

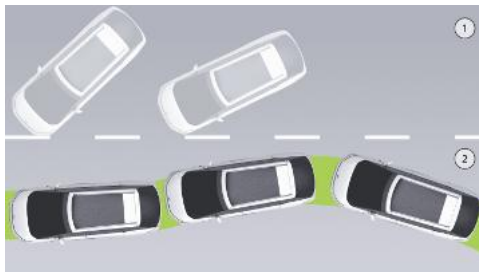

1. ESC OFF: The vehicle is more likely to skid or spin.
2. ESC ON: The risk of skidding or spinning can be reduced.

For everyday driving, it is recommended that you keep ESC turned on at all times.

Sinking escape when the wheels are spinning in place

If the wheels are spinning in place (such as when starting off on icy, snowy, or muddy roads, or in



similar situations), you may temporarily turn off ESC. After sinking escape, turn ESC back on.

In the touchscreen, go to the “ → **Settings** → **Vehicle** → **Drive Mode**” screen to turn the ESC function on or off.

ESC indicator light

When ESC is turned off, the  indicator light will be shown on the instrument panel.

When ESC is actively operating, the  indicator light will flash continuously on the instrument panel. If there is a fault in the ESC system, this indicator light will remain on.

warning

- The electronic stability system is a safety aid and when the electronic stability system is switched off, less stability control is applied to the vehicle. Do not switch off the electronic stabilization system in exceptional circumstances (e.g., when the vehicle is trapped).

- The Electronic Stability System does not handle all conditions or road conditions. It is the driver's responsibility at all times to drive the vehicle safely and carefully and to comply with the laws and traffic regulations in force.
- If ESC fails, please contact the XPENG Automobile Service Center immediately for repair.

Anti-lock Braking System (ABS)

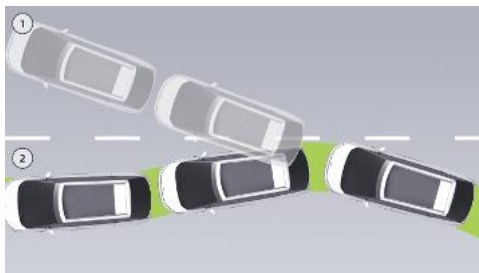



1. On vehicles not equipped with ABS, if the front wheels lock, the vehicle may lose steering capability. If the rear wheels lock, the vehicle may experience fishtailing.
2. On vehicles equipped with ABS, the ABS prevents the wheels from locking when maximum braking force is applied. Under most road conditions, it can improve the vehicle's steering control performance during emergency braking. During emergency braking, the ABS continuously monitors the speed of each wheel and adjusts brake pressure according to the incipient locking condition.

i Tips

- When the ABS intervenes, you may feel vibration in the brake pedal. This is normal. Do not panic and continue to drive according to the road conditions.
- If the ABS malfunctions, the basic braking function remains normal and is not affected

by the ABS failure, but the braking distance will increase.

! warning

The driver should always maintain a safe distance from the vehicle in front and be aware of dangerous driving conditions. Although ABS can improve the braking distance, it does not go beyond the laws of physics, nor does it prevent the danger of tire slippage (e.g. when there is a layer of water between the road and the tire that prevents the tire from contacting the road directly).

Emergency braking

In an emergency, press the brake pedal all the way down and maintain steady pressure. The ABS varies the brake pressure applied to each wheel according to the available braking force, preventing wheel lock-up and helping ensure a safe stop.

Indicator light



Observe the  indicator light on the instrument display:

- After the vehicle is powered on, the ABS indicator light illuminates for a few seconds and then goes out, indicating that the system is operating normally. If the ABS indicator light does not go out after lighting up, the anti-lock braking system is malfunctioning. Drive with caution and contact an XPENG service center for inspection and repair.
- If the ABS indicator light remains on while the vehicle is in motion, the anti-lock braking system is malfunctioning. Drive with caution and contact an XPENG service center for inspection and repair.

Distributed Traction Control System (dTCS)

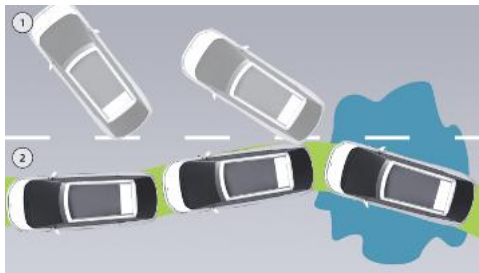

1. On vehicles not equipped with dTCS, the drive wheels may slip when starting off or accelerating sharply on slippery surfaces such as ice or snow.
2. On vehicles equipped with dTCS, dTCS controls brake pressure and overall vehicle torque output to minimize wheel spin as much as possible.



Brake Assist System (EBA)

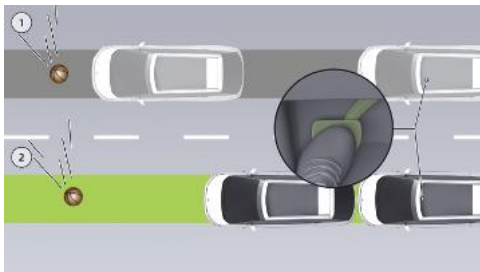

1. On vehicles not equipped with EBA, if sufficient force cannot be applied to the brake pedal within a short time during emergency braking, the braking system will not generate maximum braking force, resulting in increased braking distance and a higher risk of an accident.
2. On vehicles equipped with EBA, in an emergency, quickly depress the brake pedal and hold it. EBA will generate a brake pressure higher than during normal braking, enabling

the braking system to produce the pressure required for maximum vehicle deceleration in the shortest possible time, thereby achieving the shortest braking distance.

Multi-Collision Brake (MCB)

After the vehicle experiences an initial collision (airbags are deployed), MCB automatically applies the brakes to reduce vehicle speed or bring the vehicle to a stop, thereby reducing the likelihood and severity of a secondary collision.

Hill Descent Control (HDC)

Hill Descent Control (HDC) can automatically apply the brakes while the vehicle is going downhill to help the driver descend steep slopes at a steady and safe speed.

In the touchscreen, go to the “ → **Settings** → **Vehicle** → **Drive Mode**” screen to turn the HDC function on or off.

After HDC is turned on, when driving on a downhill section, HDC will automatically activate



and the  indicator will be shown on the instrument panel. At this time, the system will automatically control the downhill speed.

HDC can only be activated when all of the following conditions are met:

- Vehicle speed is greater than 8 km/h but does not exceed 35 km/h.
- The road slope is at least 5%.
- The brake disc temperature is within the normal range.
- The ESC system is functioning normally.

Tips

When HDC is active, if the driver presses the brake pedal or accelerator pedal, the function will exit and the driver must then take control of the vehicle.

warning

HDC can actively keep the vehicle's speed down, but not beyond the dynamics, and for safety reasons, the driver should follow the

actual conditions of the vehicle. Apply the brakes in a timely manner to avoid an accident when the vehicle is downhill too quickly.

Hill Hold Control (HHC)

Hill Hold Control (HHC) can help you when starting on a slope steeper than 5% by automatically maintaining brake pressure for a short period (about 2 seconds) between releasing the brake pedal and pressing the accelerator pedal, to prevent the vehicle from rolling backward.

warning

The HHC is capable of providing brake assistance, but not exceeding the rules of kinematics, and for safety reasons, the driver should, depending on the vehicle, Apply the brakes in a timely manner to avoid an accident when the vehicle is rolling off a slope.



Four-Wheel Drive System*

Introduction

This vehicle is equipped with an on-demand four-wheel drive system that does not require driver intervention. The system will intelligently switch between two-wheel drive and four-wheel drive modes according to the vehicle operating conditions.

When the vehicle is driven on good road surfaces, to ensure driving comfort and efficiency, it will primarily operate in two-wheel drive mode and switch to four-wheel drive mode when the driver demands high power. When the vehicle is driven on wet or slippery roads, muddy roads, icy or snowy roads, sandy roads, or complex off-road conditions, as well as during medium- to high-speed acceleration or high-dynamic cornering, the on-demand four-wheel drive system can intervene in a timely manner. By intelligently distributing torque, it ensures traction at all four wheels, achieving optimal

passability and safety, and maintaining driving stability and comfort.

Acoustic Vehicle Alerting System (AVAS)

Function Overview



When the vehicle is in motion and the speed is below 30 km/h, it will emit a simulated sound to remind nearby pedestrians and vehicles to pay attention to safety.



Touchscreen Settings

In the touchscreen “ → **Settings** → **Sound**” screen, you can temporarily turn off the Acoustic Vehicle Alerting System and set the simulated sound effect.

Tips

The alert sound function can only be temporarily turned off when there are no other road users within a short distance and the surrounding environment clearly does not require an alert sound. However, this function cannot be completely turned off; it will automatically turn back on after restarting the vehicle.

Driving Recommendations

Driving Precautions

For your safety and that of your passengers, carry out the following checks on the vehicle before each trip:

- Check whether there are any obstacles around the vehicle.
- Check whether there is any abnormal fluid accumulation under the vehicle (water from the air conditioner system is normal).
- Check all tires for abnormal wear and verify that the tire pressures are normal.
- Check that any cargo is securely loaded.
- Check that the on-board tools are present.
- Check that the wiper system operates properly.
- Check that the vehicle lighting system functions properly.
- Check that the windows are clear and that the mirrors provide good visibility.
- Check that the seats and seat belts function properly.
- Check the vehicle's remaining driving range and whether there are any warning messages on the instrument panel.



- Check that there are no foreign objects around the brake pedal and accelerator pedal that could interfere with their operation.

Make sure all of the above items meet the requirements; otherwise, your driving safety may be affected. If you need assistance, promptly contact an XPENG service center.

warning

Please do not wear high heels or slippers while driving.

Long-distance driving

Before long-distance driving, be sure to observe the following:

- To ensure your travel safety, check the vehicle condition before undertaking long-distance driving.
 - Plan your route in advance and make sure the vehicle has sufficient driving range.
 - Obey traffic regulations, take regular breaks, and do not drive while distracted.
- Bring water and necessary food to replenish energy in a timely manner.

Night driving

Visibility is reduced at night. When driving at night, be sure to observe the following:

- Do not drive when fatigued.
- Before driving, check that the horn and vehicle lighting system function properly.
- Pay close attention to the road conditions within the area illuminated by the headlights.
- Use high beams and low beams correctly.
- Do not look directly at the headlights of oncoming vehicles.
- To avoid colliding with the vehicle ahead due to delayed reaction in an emergency, increase your following distance appropriately.
- Avoid overtaking at night as much as possible. If you must overtake, do so only after confirming that the surrounding and road conditions permit it.



- When visibility is impaired, drive cautiously at low speed, pay attention to the surroundings and road environment, and be prepared to brake at any time in an emergency.

Family Use Precautions

Transporting children

When traveling with children, to ensure their safety in the vehicle, be sure to observe the following precautions:

- Never allow a child to ride in the vehicle without proper protection.
- Do not leave children alone in the vehicle.
- Do not hold a child in your arms while riding in the vehicle.
- Do not allow children to stand in the vehicle, kneel on the seat, or extend any part of their body out of the window.
- When children are seated in the rear, it is recommended to activate the rear door child safety locks to prevent them from accidentally opening the doors.

- Children under 12 years old (or shorter than 1.5 m) should not ride in the front passenger seat.
- When children under 12 years of age (or shorter than 1.5 m) are riding in the vehicle, you must use a suitable child safety seat, ensure they sit in the correct position, and fasten the seat belt.
- If a rear-facing child safety seat is installed on a rear seat, it is necessary to move the corresponding front/second-row seat appropriately forward; if a forward-facing child safety seat is installed on a rear seat, you may need to adjust the height of the headrest.
- If your vehicle is equipped with a driver headrest audio system, you can activate Private Mode while children are resting to prevent music, navigation prompts, and similar sounds from waking them.

Elderly passengers

When traveling with elderly passengers, to ensure their safety in the vehicle, be sure to observe the following precautions:



- Make sure elderly passengers sit in the correct position and fasten their seat belts.
- Do not leave elderly passengers alone in the vehicle.
- Open the windows slightly or use the air conditioner to keep the air inside the vehicle fresh, which can help prevent headaches, dizziness, and similar symptoms in elderly passengers.
- Slow down and pass carefully over bumps or through curves to avoid excessive vehicle shaking that could cause dizziness, palpitations, or similar discomfort in elderly passengers.
- When elderly passengers are seated in the rear, it is recommended that you activate the child safety locks on the doors to prevent them from accidentally opening the doors.
- If your vehicle is equipped with a driver headrest audio system, you can activate Private Mode while elderly passengers are resting to prevent music, navigation prompts, and similar sounds from waking them.

Pets in the vehicle

When traveling with pets, to ensure their safety in the vehicle, be sure to observe the following precautions:

- Do not leave pets alone in the vehicle.
- Do not allow pets to sit in the front row to avoid obstructing your view.
- Secure pets properly while driving, for example by using a suitable pet carrier.
- Secure your pet before opening the door to prevent accidents involving the pet.
- Avoid fully opening the windows for ventilation, and keep the windows near pets closed to prevent them from sticking their heads out and being injured.

Driving in Special Conditions

Driving in rainy weather

When driving in rainy weather, your visibility may be reduced. Be sure to observe the following precautions:



- Make sure the wiper system and wiper blades are functioning properly.
- Make sure the vehicle's lighting system is functioning properly.
- Make sure the tire pressure is within the normal range.
- Make sure the vehicle's brake system is functioning properly.
- Turn on the rear fog lights to alert drivers behind you.

Driving through water

When the vehicle is driven through water, to avoid vehicle damage or functional failures, be sure to observe the following precautions:

- Before entering water, slow down or stop to check the water level. The water depth must not exceed the lower edge of the vehicle body. If the water is deep or the road conditions are unclear, you must detour and must not attempt to force your way through.

- While driving through water, do not stop. Maintain a low speed (no more than 10 km/h).
- After driving through water, gently apply the brakes repeatedly to help drain water and restore braking performance. Avoid hard braking unless it is an emergency.
- After driving through water, as soon as it is safe, perform the following checks:
 - Lightly press the brake pedal; the heat generated by friction will help dry the brake pads. Check that the brakes are operating properly.
 - Check that the horn is working properly.
 - Turn the steering wheel to check that the power steering is functioning properly.
 - Check that all exterior lights are working properly.

warning

- Before wading the vehicle, check the water depth to ensure the vehicle is safe to pass through.



- Do not wade for long periods of time to avoid damage to the vehicle.
- Do not continue to use the vehicle and contact the Xpeng Automobile Service Centre immediately after water ingress is detected, to avoid personal injury or vehicle damage due to mechanical damage to the power battery or high voltage safety.

Driving in cold weather

When driving in cold weather, to avoid traffic accidents and ensure your comfort, be sure to observe the following precautions:

- In cold weather, you can use the mobile App to preheat the cabin with the climate control system.
- While driving, activate the front/rear windshield defrost (and exterior mirror heating) functions in a timely manner.
- If you are driving on icy or snow-covered roads, you should also install snow chains.

- When driving on icy or snowy roads, be sure to reduce your speed and drive carefully. Avoid hard braking, sudden acceleration, or abrupt steering inputs whenever possible, as these may cause loss of vehicle control and lead to an accident.
- When driving on roads in winter, replace all four tires with winter tires at the same time, and ensure that all four wheels use winter tires of the same diameter, brand, construction, and tread pattern.
- If the road surface is icy or snow-covered, or in low-temperature rain and snow conditions, it is recommended that you park the vehicle on a level section of road and shift the gear selector to P. If necessary, place wheel chocks.

Driving in hot weather

When driving in hot weather, to ensure passenger comfort, you can take the following measures:



- In hot weather, you can use the mobile App to precool the cabin with the air conditioner system.
- Before getting into the vehicle, open the windows to ventilate and let the hot air inside dissipate.
- When there are passengers on board, promptly switch on the seat ventilation function.
- When turning on the air conditioner, first select internal circulation mode so that the hot air in the vehicle can fully dissipate, then switch to internal circulation mode to retain the cool air and lower the temperature quickly.
- Prepare oxygen, medications, and other equipment needed to deal with altitude sickness.
- Before driving up or down a long slope, check the condition of the brake system, steering system, drivetrain, and wheels.
- After entering high-altitude areas, frequently check the tire pressure and, if necessary, appropriately reduce the tire pressure.
- Frequently pressing the brake pedal to brake will cause the temperature of the brake fluid, brake discs, and brake pads to rise, reducing braking performance and, in severe cases, leading to brake failure.
- Due to the effects of high-altitude environments, the vehicle's driving range may be reduced. Pay close attention to the vehicle's condition.

Driving in plateau/high-altitude environments

When driving in plateau or mountainous areas, vehicle performance can vary significantly due to geographical conditions, altitude, and other environmental factors. Please pay attention to the following:

Driving on smooth/slippery road surfaces

Epoxy flooring, emery flooring, tiled roads, and other smooth surfaces have very low friction coefficients. When there is water on the surface,



the friction coefficient is even lower, approaching that of ice. When driving on smooth or slippery road surfaces, observe the following:

- The vehicle can easily skid; reduce speed and drive slowly, and avoid rapid acceleration, sudden braking, or sharp steering inputs.
- Braking distances will be longer; keep a sufficient following distance and constantly monitor road conditions to avoid rear-end or other collisions.
- The vehicle can easily become difficult to control; overtake with caution, and do not overtake blindly or accelerate sharply while overtaking.



In-Vehicle Navigation

Seamless Navigation

After logging in to and binding the XPENG App, Seamless Navigation allows you to send an address from your mobile to the vehicle and quickly start navigation.

Using the XPENG App as an example, you can enable Seamless Navigation by performing the following steps:



1. Switch the XPENG App to the “**XPENG**” screen, tap “**Send Address**” to enter the search interface, and set the navigation destination.
2. Tap “**Send to Vehicle**” to send the destination information to the vehicle’s touchscreen.
3. After the touchscreen receives the navigation information sent from the phone, a confirmation card will pop up. Tap “**OK**” to enable Seamless Navigation.

In the touchscreen, tap “”, then in the App Center tap “**User Portfolio**→**Account Binding Management**→**Navigation**” to view the third-party Apps supported by Seamless Navigation. Tap each third-party App icon separately to view settings and usage instructions.

Tips

The success rate of sending addresses from certain third-party Apps to the vehicle can be influenced by various factors, including the address information, and failures in sending can be possible.

Trip Planning

You can plan long-distance charging through the mobile App on the “**XPENG**→**Charging Center**→**Journey Planning**” screen.

1. Enter the starting point and destination;
2. Select charging stations, such as highway stations, free stations, fast-charging stations, and XPENG-operated stations;



3. Tap “**Strategy Adjustment**” to set options such as departure at full charge, maximum range, range before charging, charging strategy, and route preferences. After configuration, tap “**Confirm**”;
4. Tap “**Send to Vehicle**” to send the planned route to the touchscreen for navigation.

Navigation Settings

Route Planning

In the touchscreen, in the “ →**Settings**→**Map**→**Navigation**” screen, you can configure route planning as needed.

1. Route preferences: You can select one or more preferences as needed from options such as "Smart recommendation", "Expressways first", "Avoid expressways", "Avoid congestion", "Lower tolls", "Major roads first", or "Time first".
2. Avoid restricted zones: Before turning this on, you must set the license plate number (the plate number must use uppercase English

letters and digits). After the license plate number is set, the system will help you avoid urban road sections with license-based restrictions.

3. Smart charging recommendations: After this is turned on, when the battery is low, charging stations will be recommended based on your preferences.
4. Parking recommendations: After this is turned on, when navigation is approaching the destination, parking lots near the destination will be recommended. If an Amap account is linked, a walking route will be sent automatically to the Amap App.

Display

In the touchscreen, in the “ →**Settings**→**Map**→**Navigation**” screen, you can configure navigation display as needed.

1. Layer display: You can choose to display one or more map layers as needed, such as "Real-time traffic", "Traffic incidents", "Charging



- stations", "My favorites", or "Experience and service centers".
- 2. Navigation floating window: After this is turned on, during navigation a floating map window is displayed on the home screen, allowing you to quickly check traffic conditions farther ahead.
- 3. Vehicle icon compass: After this is turned on, a compass showing north, south, east, and west is displayed around the vehicle icon.

Broadcast

In the touchscreen, in the “ → **Settings** → **Map** → **Navigation**” screen, you can configure navigation announcement as needed.

1. Navigation announcement: You can select a navigation announcement mode as needed.
 - Detailed: Deliver the most detailed broadcasts, ideal for new drivers.
 - Standard: Default Mode. The volume of broadcasted content is moderate, suitable for most users.

- Concise: Focus on road directions with more concise broadcasts, suitable for experienced drivers.
2. Cruise announcements: Even when not in navigation, you can still specify the real-time traffic information that you want. You can choose as needed to turn on one or more of: "Traffic ahead", "Safety reminders", or "Speed camera".

Personalized Settings

Commuter Options

In the touchscreen, in the “ → **Settings** → **Map** → **Individual**” screen, you can set the home address, work address, and commute function as needed.

1. Home address: You can view, add, and manage (edit and delete) the home address.
 - Add home address: Tap "Home", then enter the home address on the map to search for and add the home address.



- Edit home address: After a home address has been set, tap the edit icon for the existing home address to search for and add a new home address.
 - Delete home address: After a home address has been set, tap the edit icon for the existing home address, then, after reading and acknowledging the pop-up message, you can delete the existing home address.
2. Work address: You can view, add, and manage (edit and delete) the work address.
- Add work address: Tap "Work", then enter the work address on the map to search for and add the work address.
 - Edit work address: After a work address has been set, tap the edit icon for the existing work address to search for and add a new work address.
 - Delete work address: After a work address has been set, tap the edit icon for the existing work address, then, after reading

and acknowledging the pop-up message, you can delete the existing work address.

3. Commute function: After this is turned on, during the set time period, a commute card will automatically appear on the home screen to remind you to depart.
- Go-to-work time: You can set the time period for going to work as needed.
 - Work end time: You can set the time period for getting off work as needed.

Frequent Places

In the touchscreen, in the "  → **Settings** → **Map** → **Individual** " screen, you can manage frequent places.

- Add frequent places: Tap "Add frequent places", then enter the address on the map to search for and add the address of the frequent places.
- Edit frequent places: Select the edit icon for the frequent places you want to update, tap Edit in the pop-up window, then search for and add a new frequent place.



- Delete frequent places: Select the edit icon for the frequent places you want to update, tap Delete in the pop-up window, then, after reading and acknowledging the pop-up message, you can delete the selected frequent places.

Shift the car into D gear to start the navigation automatically

In the touchscreen, go to the “ → **Settings** → **Map** → **Individual**” screen to enable/disable the Shift the car into D gear to start the navigation automatically function.

User Data Deletion

In the touchscreen, tap in sequence “ → **Settings** → **Map** → **Individual** → **User Data Deletion**”. After reading and confirming the pop-up message, you can delete navigation history, saved locations, sent-the-address-to-car, and other data associated with the account.

Road Environment Surrounding Reality

Function Overview

Using sensors, the system detects the external road environment and the current status of the vehicle, and it displays detected road signs, other traffic participants, and related information in real time in the touchscreen and the instrument panel, creating a vehicle-centered virtual display interface.

Instrument Panel SR Screen



Touchscreen SR Screen

The SR screen includes the following functions:



- Vehicle Malfunction Display [See 290 page](#)
- Driving Risk Warning [See 291 page](#)
- Preceding Vehicle Starting Reminder [See 292 page](#)
- Green Light Reminder for Starting [See 295 page](#)
- Overspeed Reminder [See 295 page](#)
- Lane-Level Navigation [See 295 page](#)

Warnings, Cautions, and Limitations

warning

SR is an assisted driving function only and you, as the driver of the vehicle, are responsible for driving safety and do not rely on this function to control the vehicle as injury or death may result.

warning

The SR does not work in the following scenarios:

- Camera restricted.

- The vehicle is traveling on a large bend or in poor road conditions.

warning

The SR may have the following conditions:

- An object of one type is displayed incorrectly as an object of another type.
- Shows an object in the wrong direction, distance simulation.

The above warnings, cautions, and limitations do not cover all conditions that may affect normal SR operation.

Vehicle Malfunction Display

Function Overview

When the vehicle is in Park (P), the vehicle can continuously monitor common body-related faults (such as abnormal tire pressure) and mark the specific fault location on the 3D vehicle model in the SR interface in red.



warning

The vehicle fault display only supports monitoring some common basic faults of the vehicle. Do not rely on this function to monitor vehicle faults. If you find any abnormalities in the vehicle, please contact the XPENG Motors service center in time for assistance.

Touchscreen Settings

In the touchscreen, go to the “ → **Settings** → **Map** → **Safety**” screen to turn the Vehicle Malfunction display on or off.

Driving Risk Warning

Function Overview

When the XPILLOT ASSIST system is not activated and the vehicle is in D gear, if nearby moving obstacles are too close to the vehicle or pose a potential safety risk, the SR screen will issue a warning alert.

Obstacles indicating medium risk will turn red; obstacles indicating high risk will turn red and be accompanied by an audible alert.

Touchscreen Settings

In the touchscreen, in the “ → **Settings** → **Map** → **Safety**” screen, you can turn the Driving Risk Alert sound on or off.

Warnings, Cautions, and Limitations

The Driving Risk Warning is for alert purposes only. The driver is responsible for observing the surrounding environment and making appropriate decisions.

warning

A trip hazard alert may not be triggered in the following situations. This includes, but is not limited to:

- Radar or camera restricted.
- Driving on a road surface with a large bend.



- When driving on road surfaces in poor conditions and conditions.

The above warnings, cautions, and limitations do not cover all conditions that may affect the normal operation of the Driving Risk Warning.

Preceding Vehicle Starting Reminder

Function Overview

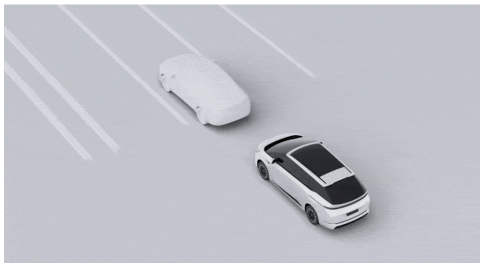

When XPILOT ASSIST is not activated and the vehicle is being driven in D, if you are in

congested traffic and the vehicle ahead moves a certain distance away, the SR interface will display an animation effect and a chime will sound to remind the driver to set off.

Touchscreen Settings

In the touchscreen, in the “ →Settings→Map→Safety” screen, you can turn the Preceding Vehicle Starting Reminder on or off.

Warnings, Cautions, and Limitations

warning

The Front Launch Alert may not be triggered if:

- There are pedestrians, bicycles, motorcycles, etc. in front of you.
- No vehicles ahead.
- The vehicle is in gear other than D.
- The vehicle speed is greater than 0 km/h.
- The vehicle in front is a long distance from the vehicle in front.



- The front and rear vehicle are stationary for a short period of time.

warning

The front drive away alert can be inhibited under certain conditions, including but not limited to the following:

- Poor visibility at night.
- Poor visibility due to bad weather such as heavy rain, heavy snow, fog, sand, etc.
- Intense light, back lighting, water reflective, extreme light contrast.
- Camera restricted.

The above warnings, cautions, and limitations do not cover all conditions that may affect the normal operation of the Preceding Vehicle Starting Reminder.

Green Light Reminder for Starting

Function Overview

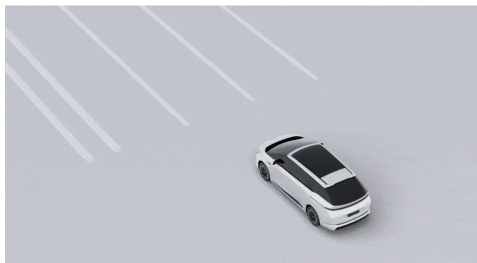

When the XPILOT ASSIST system is not activated and the vehicle is in D gear, if the traffic signal turns green while stopped and the vehicle has not started, the SR screen will display a green-light start animation effect and emit an audible alert to remind the driver to set off.



Touchscreen Settings

In the touchscreen, in the “ → **Settings** → **Map** → **Safety**” screen, you can turn the Green Light Reminder for Starting on or off.

Warnings, Cautions, and Limitations

warning

Green Launch Reminder may not be triggered in the following situations, including but not limited to:

- The system does not recognize the traffic light message.
- Vehicles or non-motorized vehicles or pedestrians are in front of you.
- The vehicle is in gear other than D.
- The vehicle speed is greater than 0 km/h.

Green Launch Alerts are inhibited under certain conditions, including but not limited to the following:

- Poor visibility at night.

- Poor visibility due to bad weather such as heavy rain, heavy snow, fog, sand, etc.
- Intense light, backlighting, water reflective, extreme light contrast.
- Camera restricted.

The above warnings, cautions, and limitations do not cover all situations that may affect the normal operation of Green Light Reminder for Starting.



Overspeed Reminder

Function Overview

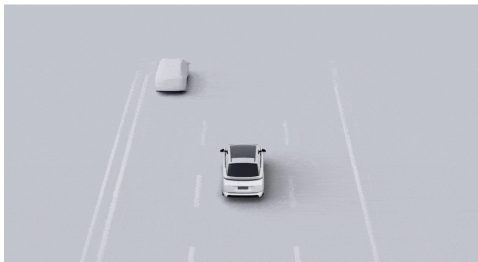

The system will detect the speed limit of the current road and safety cameras in real time. If the vehicle speed exceeds the limit by a certain extent, visual alerts will be triggered from the dashboard and touchscreen along with sound warnings.

Touchscreen Settings

In the touchscreen, in the “ → **Settings** → **Map** → **Safety**” screen, you can turn the Overspeed Reminder on or off.

Lane-Level Navigation

Function Overview

Lane-level navigation deeply integrates traditional lane-level guidance with real-time SR (Simulated Reality) road-environment rendering. On the basis of conventional lane-level navigation, it adds information such as surrounding road structure, lane markings, and the positions of other traffic participants around the vehicle, avoiding the need to frequently switch between the navigation and SR screens while driving to obtain necessary information.

Tips

Lane level navigation is on by default and does not need to be set manually.



warning

车 item accessibility, for reference only, It is not intended to replace the operator's view of the surrounding environment. — to control the vehicle. Failure to do so could result in injury.



360 Camera

Function Overview

The 360° Around View Monitor (AVM) uses surround cameras around the vehicle to capture the surrounding environment and display it in the touchscreen.

The surround cameras are installed above the front and rear license plates and under the left and right outside rearview mirrors.

warning

AVM (Autonomous Vehicle Monitor) is an assistive feature that provides only reference and cannot replace the driver's observation of the surrounding environment. AVM cannot handle all traffic, weather, and road conditions. As the driver, you are responsible for your driving safety. Do not rely on this feature to control the vehicle, as this may result in injury.

Turn AVM on/off

You can turn on the AVM function in any of the following ways:

- When the gear position is shifted to Reverse (R), AVM turns on automatically.
- Tap the  icon (such as Settings) on the taskbar at the bottom of the touchscreen.
- Turn on AVM using voice commands, for example, by saying keywords such as “Turn on 360° Around View Monitor.”
- When the steering wheel shortcut in the touchscreen is set to **“Turn 360 Camera On/Off”**, you can turn it on using the steering wheel shortcut.

You can turn off the AVM function in any of the following ways:

- On the 360 Camera screen, tap  in the upper left corner to turn off the 360 Camera.
- Turn off AVM using voice commands, for example, by saying keywords such as “Turn off 360° Around View Monitor.”



- When the steering wheel shortcut in the touchscreen is set to **“Turn 360 Camera”**, you can turn it off using the steering wheel shortcut.

2D mode screen



1. 3D/2D mode switch.
2. View angle switch icon.
 - In 2D mode, you can use  on the vehicle model to switch to front, rear, left, right, and wheel-hub views.

- If there is no screen operation within 5 seconds, the icons are hidden automatically. Tap the view area to display them again.

3. Dynamic guide lines

- The vehicle width is indicated by two thin white lines.
- In the front/rear views, segmented scale lines indicate the distance between the vehicle and an object.
- From near to far, the distances represented by the scale lines are approximately 0.6 m, 1 m, and 1.5 m.

4. Tire trajectory area

- Indicates the path of the wheels.

5. Safe stop line

- Indicates a position approximately 0.3 m from the vehicle.



warning

Stop the vehicle when the safety stop line contacts an obstacle.

6. Camera Settings

Tap “

7. Radar warning

- Simulated display based on the distance and direction of obstacles.
- When white is displayed, the distance is relatively far.
- When red is displayed, the distance is very close.
- The distance between the vehicle and the nearest obstacle is also displayed numerically at the front and rear of the vehicle.

3D mode screen



- After switching to 3D mode, the system integrates a 3D virtual vehicle model into the real-world camera view.
- Slide around the circular ring on the left vehicle model  or directly rotate the right vehicle model to freely rotate the view 360°.
- If there is no screen operation within 5 seconds, the ring and icons are hidden automatically. Tap the top view area to display the ring and icons again.



Reversing Image Hold

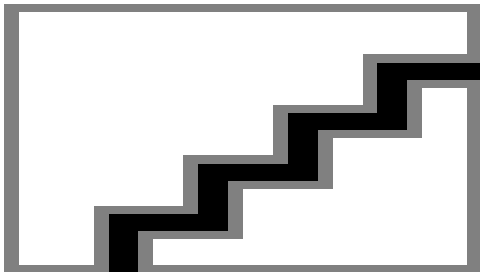

In the touchscreen, tap in sequence “ → **Settings** → **XPILOT ASSIST** → **Parking Scenarios**”, where you can turn “**Reversing Image Hold**” on or off.

When this function is enabled, when the gear position is shifted from R to D, the 360 Camera switches to the front view. When the gear is shifted to P or the vehicle speed exceeds 10 km/h, the 360 Camera will automatically exit.

Wheel Hub View Switching While Reversing

When reversing, you can tap the wheel hub view switching icon in the touchscreen to switch between the rear view, the front wheel hub view, and the front and rear wheel hub view.

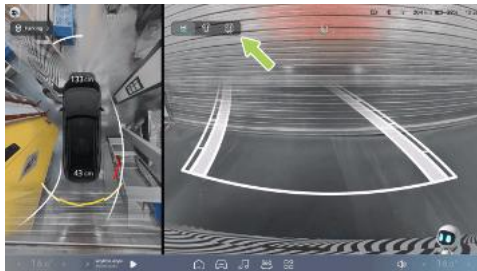

360 Camera Auto Turn Off

In the touchscreen, tap in sequence “ → **Settings** → **Intelligent Imaging**” to open the screen, where you can enable/disable “**Auto Turn Off 360 Camera**”.



After this function is enabled, if the 360 Camera is turned on manually, it will automatically turn off when the speed exceeds 30 km/h and there is no operation for 5 seconds.

Warnings, Cautions, and Limitations

warning

Objects in the AVM picture are deformed from actual objects. AVM may not work in the following scenarios:

- Camera restricted.
- Camera blocked (dust, cover, etc.) or poor weather conditions (e.g. heavy rain, heavy snow, heavy fog).

The above warnings, cautions, and limitations do not cover all conditions that may affect normal AVM operation.

3D Transparent Body

Function Overview

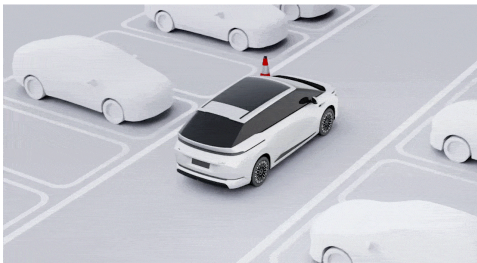

After the 3D Transparent Body function is enabled, when the AVM screen is switched to 3D display mode, the 3D vehicle model on the right becomes semi-transparent, making it easier to check for collision risks around the vehicle.

warning

The 3D transparent vehicle body is an auxiliary function that can only provide a reference and



cannot replace the driver's observation of the surrounding environment. The 3D transparent vehicle body cannot cope with all traffic, weather, and road conditions. As the driver, you are responsible for driving safety. Do not rely on this function to control the vehicle, otherwise it may lead to injury.

Enable/Disable 3D Transparent Body

In the touchscreen, go to the “ → **Settings** → **Intelligent Imaging**” screen to enable/disable “**3D Transparent Body**”.

Interface display



1. Not enabled 3D Transparent Body
2. Enable 3D Transparent Body



Transparent Chassis

Function Overview

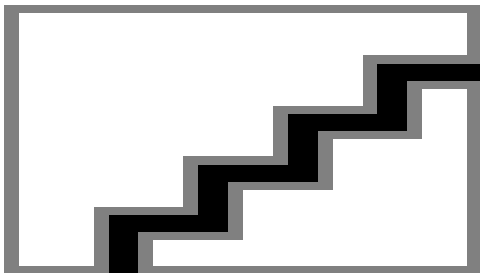

After the Transparent Chassis function is enabled, when the vehicle is driving at low speed, the top view on the left switches to Transparent Chassis, overlaying a virtual vehicle model on the real road image to make it easier to check for collision risks around the vehicle.

warning

The transparent chassis feature is an auxiliary function that provides only reference and cannot replace the driver's observation of the surrounding environment. The transparent chassis cannot handle all traffic, weather, and road conditions. As the driver, you are responsible for your driving safety. Do not rely on this feature to control the vehicle, as this may result in injury.

Enable/Disable Transparent Chassis

In the touchscreen, go to the “ → **Settings** → **Intelligent Imaging**” screen to enable/disable “**Transparent Chassis**”.



Interface display



1. Not enabled Transparent Chassis
2. Enable Transparent Chassis

Activate Panoramic Image on Narrow Roads

Function Overview



When the vehicle is in D gear, the vehicle speed is below 15 km/h, and obstacles are detected at the front or rear sides of the vehicle, the system will turn on Activate Panoramic Image on Narrow Roads to assist driving.



warning

Narrowband Active Panorama is an assistance function for reference only and does not replace the driver's view of the surrounding environment. You are responsible for driving safely as the driver of the vehicle, and do not rely on this feature to control the vehicle. Failure to do so could result in injury.

Enable and Disable Activate Panoramic Image on Narrow Roads

In the touchscreen, go to the “ → **Settings** → **Intelligent Imaging**” screen to enable/disable “**Activate Panoramic Image on Narrow Roads**”, and select the activation distance and camera angle according to driving preference.

For the trigger range, Near is approximately 50 cm, Middle is approximately 60 cm, and Far is approximately 75 cm.

You can select “**Panoramic View**” or “**Panoramic + Hub View**” as the camera view.

Activate Side Rear Image When Turning

Function Overview

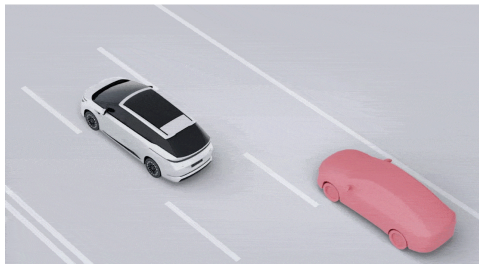

When the vehicle is in D gear and a turn signal is activated, the system automatically displays the rear-side view on the corresponding side, making it easier to check the rear-side blind spot and assist driving.



warning

Rear View on the steering active side is an assistance function for reference only and does not replace the driver's view of the surrounding environment. You are responsible for driving safely as the driver of the vehicle, and do not rely on this feature to control the vehicle. Failure to do so could result in injury.

Enable and Disable Activate Side Rear Image When Turning

In the touchscreen, go to the “ →Settings→Intelligent Imaging” screen to enable/disable “**Activate Side Rear Image When Turning**”, and select the display position of the turn-signal image.

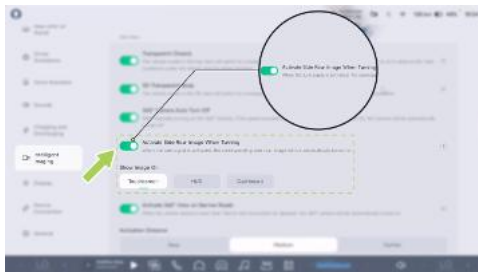

Tips

The turn signal image is displayed on the main screen by default. If you want it to be displayed on the instrument cluster, you need to select the instrument cluster as the turn signal image location.

Touchscreen interface

The position of the image in the touchscreen can be adjusted by dragging. Touch and hold the image to drag it. On the image screen, tap  to zoom the image in or out.



Driving Recorder

Function Overview



The Driving Video Recording function can record video while the vehicle is being driven and store the video files on a USB drive. The video files can be used to review past driving information when needed, or to help provide evidence in the event of an accident.



Turn Driving Video Recording On/Off

In the touchscreen, go to the “ → **Settings** → **Intelligent Imaging**” screen to enable/disable Driving Video Recording.

For Driving Video Recording, you can select to record the “**Main View**” or “**Main View + Surrounding View**”.

Driving Emergency Recording

Automatic trigger: When the “**Driving Recorder**” function in the touchscreen is turned on and recording, the system will automatically perform emergency recording and save the footage when a collision-risk event is detected.

Manual trigger: When the “**Driving Recorder**” function in the touchscreen is turned on and recording, you can tap the  icon in the top status bar of the touchscreen and then tap “**Emergency Recording**” in the pull-down menu to start an emergency recording, or tap the 



icon in the bottom taskbar of the touchscreen (if customized) to start an emergency recording.

Emergency recording storage location: In the touchscreen, go to “ → **Driving Recorder** → **Emergency Recording**” to view and export emergency recordings.

Check Driving Recorder status

Tap the  icon in the top status bar of the touchscreen to check the status of Driving Recorder.



When the Driving Recorder is turned on and recording



When the Driving Recorder is turned off



When the Driving Recorder is unavailable and the USB drive needs to be checked

Export driving recorder videos to your mobile phone

In the touchscreen “ → **Driving Recorder**” screen, “**Select**” the footage you need to transfer, then tap “” (you can also tap  in the lower-right corner of the footage screen) to enter the file transfer screen, and follow the onscreen instructions to complete the transfer:

Tips

- During file transfer, the central control screen and the mobile app should remain on the transfer interface and keep the mobile phone WiFi turned on to avoid disconnecting.
- During the file transfer, the phone will not be able to access the Internet and will resume after the transfer is complete and disconnected.



Install an external storage device

Driving recorder video data is stored on an external storage device (USB drive). If no USB drive is installed, the driving recorder function will not work properly.



The USB media source port and Type-C power port at the front of the center armrest console support data transfer. After inserting a USB drive, you can use the driving recorder function.

The driving recorder only recognizes one USB drive at a time. Each time the vehicle is powered



on, the system will first select the USB drive that was used before power-off. If the USB drive used before power-off is not detected within 3 seconds after power-on, the system will use the first detected USB drive in the read sequence as the active USB drive.

Warnings, Cautions, and Limitations

- Each driving recorder video clip is saved by default at about 1 minute in length. If, during recording, you lock the vehicle and power off, eject the USB drive, delete videos, format the drive, or switch the recording view, the recording will be interrupted. The driving recorder will save the portion already recorded, then start recording a new clip, which may be shorter than 1 minute.
- Avoid emergency power-off while the driving recorder is recording. An emergency power-off will cause the current recording to fail to save.
- Driving recorder videos are stored on a dedicated USB drive. Do not remove the USB drive directly. If you need to remove it, first go to the touchscreen “ → Driving



Recorder→**Manage Storage**” screen and tap **“Safe Eject”**. Otherwise, the video that is currently being recorded may be lost, and the USB drive as well as the video data may be damaged or lost. Avoid using adapters, docking stations, and similar devices as they can easily cause loose connections.

- When the driving recorder is turned on, it records in a loop. Once storage is full, the earliest videos will be overwritten. To prevent important videos from being overwritten, export any important videos to your mobile phone, computer, or other devices in a timely manner when necessary.
- When Low Power Consumption mode is enabled, video cannot be recorded. In the touchscreen “ →**Settings**→**XPILOT ASSIST**→**Driving Scenarios**→**More Settings**” screen, you can turn **“Battery Saver”** Mode on or off.
- When Low Power Consumption mode is enabled, video cannot be recorded. In the touchscreen “ →**Driver Assistance**→**Driving**

Scenarios” screen, you can turn **“Battery Saver”** Mode on or off.

- To better meet technical requirements, use a USB drive with a capacity of 32 GB or higher, USB 2.0 or above, and a write speed of more than 10 MB/s.
- Only USB drives with partition formats of FAT16, FAT32, or NTFS are supported. For USB drives in other formats, it is recommended to format the drive once before use. Format will delete all files on the USB drive. Back up important data before formatting.
- USB drives have a limited number of write/erase cycles and are considered consumables. If a USB drive has been used for more than six months and you notice that video reading becomes very slow or videos are frequently lost, replace it with a new USB drive.
- For your driving safety, avoid viewing video content while the vehicle is in motion.



XGUARD

Function Overview



After this function is enabled, it will continuously monitor the vehicle's surroundings after the vehicle is locked and powered off. When a person is detected continuously approaching or an abnormal vibration is detected, the system will trigger an alarm (touchscreen wakes and exterior lights flash) and record video before and after the risk event, effectively capturing potential safety hazards and malicious damage.

For vibration events, the system will also send push notifications and desensitized high-risk sentry recordings to the mobile App to promptly inform and remind the user.

You can perform the following operations for XGUARD:

- Turn on/off XGUARD and configure it via the touchscreen.
- View XGUARD footage via the touchscreen.
- Turn XGUARD on/off via the mobile App.
- View high-risk XGUARD recordings via the mobile App.

Turn on/off XGUARD and configure it via the touchscreen

In the touchscreen, in the “ → **Settings** → **Intelligent Imaging**” screen, you can turn on or off “**XGUARD**” and set the XGUARD sensitivity.

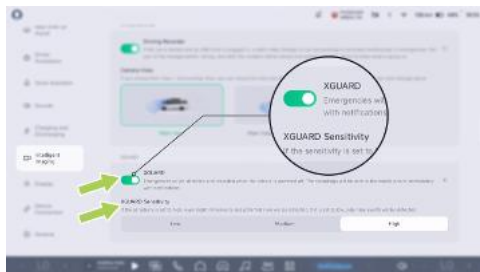

View XGUARD recordings via the touchscreen

In the touchscreen, in the “ → **Driving Recordings** → **XGUARD Recordings**” screen, you can view the original sentry recordings.

Tips

- When low-risk events take up more than 30GB or 90% of total system space, historical low-risk events are cycled to ensure timely recording of new events and high-risk events are permanently saved.

- If too much space may cause recording to fail, please go to the **Storage screen** of the central control screen to clean up.

Turn on/off XGUARD and view it via the mobile App

In the mobile App “**XPENG**” screen, you can turn on/off XGUARD, remotely view the vehicle’s surrounding images (available to the vehicle owner only), and view desensitized high-risk sentry recordings.



1. Turn on or off XGUARD



2. Remotely view the vehicle's surrounding images: you can view desensitized real-time images around the vehicle.

caution

- There may be a delay in the video feed when switching cameras.
- Remote viewing requires vehicle data usage; this function will be unavailable once the data usage is exhausted.

3. View XGUARD recordings: you can view desensitized high-risk sentry recordings.
 - When notification permissions are enabled for the mobile App, the App will push XGUARD recordings via notifications.
 - If the vehicle network connection is poor, uploads may fail or notifications may be delayed (but the footage will still be saved locally).

Warnings, Cautions, and Limitations

caution

- When Sentinel mode is used, the system accesses the camera permissions to detect the vehicle's surroundings. Please use Sentinel mode in compliance with local laws and regulations and the camera usage requirements of the location where you are located, and assume all corresponding responsibilities.
- When Sentinel mode is switched on, the vehicle security alarm may also be activated when the vehicle is subjected to an intrusion such as pry doors, prying the boot.
- Sentinel mode is only active during single-exit when switched on, and functions are automatically switched off when the vehicle is powered on.
- Sentinel mode consumes a certain amount of vehicle power, switch on if necessary.
- Battery power is continuously consumed during Sentinel mode operation and



automatically exits Sentinel mode when the vehicle range is below 50 km.

- The video of the mobile App will clear automatically after 7 days, please check it in time, the high-risk recordings of the central control screen can be saved permanently.

Occupant Monitoring System OMS (Ultra models)

Introduction

The OMS (Over-the-Air) camera captures images of the vehicle's interior and displays them on the central control screen. You can take photos or videos to record precious moments inside the car, and you can also view the interior images in real time on the central control screen. After leaving the vehicle and turning off the power, if you are unsure whether you have left any items inside, you can remotely view the interior images via a mobile app.

You can perform the following operations on the in-cabin images:

- Turn the in-car camera on/off via the central control screen.
- The in-vehicle camera can be opened/closed via a camera cover.
- View the cabin images on the central control screen.
- View or transfer in-cabin video albums via the central control screen.
- After leaving the vehicle, you can remotely view the cabin images via a mobile app.

Turn the in-car camera on/off via the central control screen

On CID “ → **Setting** → **Common** → **Security and Privacy**” interface, you can open/close “**In-Cabin Camera**” The In-Cabin Camera will be disabled after being turned off.

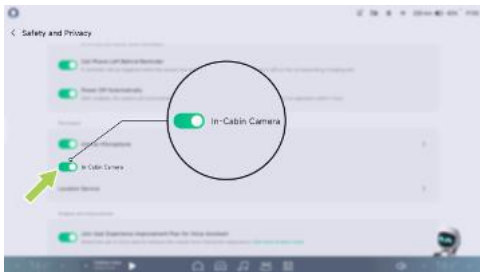

i Tips

The in-vehicle camera is off by default. When you enable the in-vehicle camera for the first time, you will be prompted to request authorization.

View cabin images via the central control screen

On CID “ → **In-cabin video**” interface. You can view images inside the cabin.

While driving, do not keep your eyes on the in-cabin image on the central control screen, otherwise you may not be able to see pedestrians and objects on the road in front of the vehicle. The following is In-cabin video operation : “**In-cabin video**” You can take photos or videos.



1. Switch between photo/video mode.
2. Timed photo capture (displayed only in photo capture mode; after enabling timed photo capture, click the "Take Photo Now" button,



and the photo will be taken after a 3-second countdown).

3. Take a photo/video immediately.
4. Reading light switch (turns on all reading lights in the vehicle).
5. Enter the photo album.
6. Take a photo now (in the video recording, click "Take a photo now").
7. Stop recording (displayed in the recording).

i Tips



- If you click "Take Photo/Video Now" and there is insufficient system space, the photo may fail to be taken. Please go to the "Settings → General → Storage Space" interface on the central control screen to clear the space.
- The maximum recording time for a single session is 10 minutes. Recording will automatically stop when 10 minutes have elapsed.

- When entering the cabin imaging application, the default mode is photo mode.
- In well-lit conditions, a full-color image will be displayed. In low-light conditions, an infrared night-view image will be displayed.

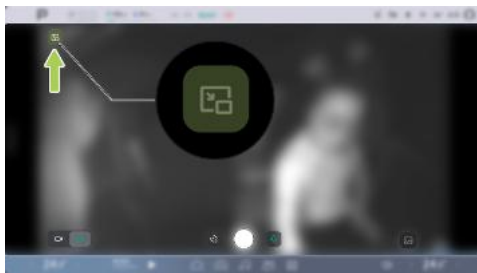
In the **"In-cabin video"** interface, click  You can shrink the screen to a floating window state. You can drag the floating window to different positions on the screen. At this time, you can only view the in-cabin image and cannot use the photo or video recording function.





In the floating window state, click  , return “In-cabin video” application interface. Click.  Turn off the in-cabin video.



Tips

Switching to floating window mode during recording may cause recording to be interrupted.

View or transfer in-cabin video album via central control screen

On CID “ →In-cabin video” interface allows you to view the videos or pictures you’ve taken. You can also select the videos or pictures you want to send to your phone or delete the ones you don’t need.

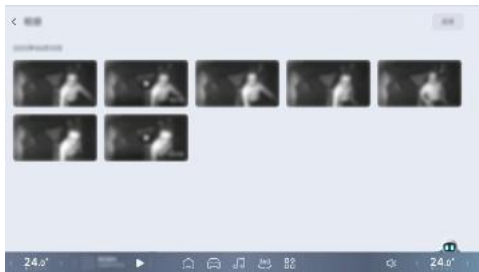





caution

For your safety, we recommend that you view the images and videos while the vehicle is parked.

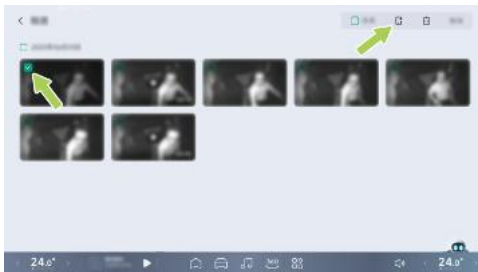

Export cabin images to mobile phone*(If applicable)



On CID “ →In-cabin video”interface , click “**select**”the button to enter selection mode, select the video or image you want to transfer, and then click. “”(Alternatively, you can click on the video or image details page.) Enter the file transfer interface and follow the prompts to perform the transfer operation.

Tips

- During file transfer, both the central control screen and the mobile app should remain on the transfer interface, and the mobile phone's WiFi should be turned on to avoid interrupting the connection.
- During file transfer, the phone will be unable to access the internet; the connection will be restored after the transfer is complete and the connection is closed.

Warnings, cautions and limits

caution

- During OMS recording, please avoid emergency power-offs as much as possible, as emergency power-offs will cause the recording video to be lost.
- When the low power saving mode is enabled, the OMS function will not be available.
- The OMS function will not be usable if the OMS camera temperature is too high.



- The in-vehicle camera should be kept clean, and any dirt should be removed promptly.
- If the in-cabin video fails to display properly, please contact XPeng Motors Service Center for repairs.



Driver Assistance Overview

Driver Assistance Components

Radar

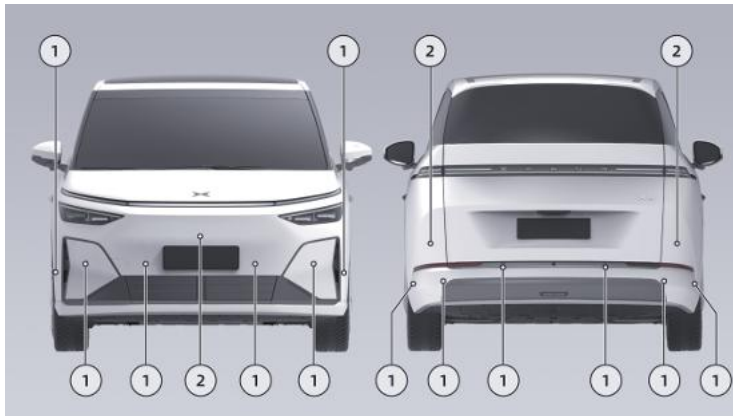

1. Ultrasonic radar

2. Millimeter-wave radar



"Camera"

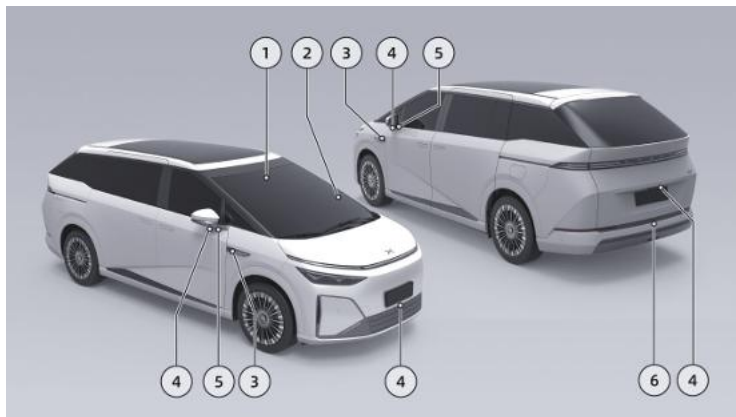

1. Binocular camera

2. DSM camera

3. Rear side camera

4. Surround camera

5. Front side camera

6. Rear-view camera



warning

If the radar and camera functions are limited, the driver assistance functions will not be able to be activated or function properly.



General Precautions

Safety Exam

To ensure your safety and make sure you have mastered the safe operation of the assisted driving features, you must study the safety guidelines and complete the safety exam before using certain functions.

On the touchscreen, go to the “ → **Settings** → **XPILOT ASSIST** → **Driving Scenarios** → **Safety Exam**” screen. After completing the driving safety exam, you can use the following functions:

- Lane Centering Control
- Highway Navigation Guided Pilot
- XPENG Navigation Guided Pilot
- Space-to-Space

On the touchscreen, go to the “ → **Settings** → **XPILOT ASSIST** → **Parking Scenarios** → **Safety Exam**” screen. After

completing the parking safety exam, you can use the following functions:

- Advanced Parking Assist

warning

The safety test results are linked to the vehicle owner's account. When lending your vehicle to others, please log out of your account on the central control screen to prevent accidents caused by people who have failed the safety test misusing the driver assistance functions.

Limitations of Radar and Cameras

Tips

Before each use of the driver assistance function, please ensure that the radar and camera surfaces are clean and unobstructed.

warning

The following conditions can cause the radar/camera to fail to recognize the target, delay in recognition, or incorrect identification:



- The radar or camera is obscured or dirty, such as by snow, frost, rain, Foreign objects such as water, dirt, etc. are attached.
- Faulty radar, camera or associated component.
- Severe weather, such as rain, snow, fog, etc.
- Road bumps or other causes cause the vehicle to rock.
- There is interference from the same frequency of acoustic Boeing sources around the vehicle.
- Objects in the vehicle's vicinity that can cause the sonic to reflect incorrectly.
- The target detected by the radar is attached to substances that absorb sound waves, such as snowflakes, foams, cotton objects, etc.
- The detected object is too small.
- In rare exceptional cases, false alarms may occur on some metal barriers, green belts, cement walls, etc.

- When the ambient brightness changes, such as tunnel entry or exit.
- Large shadows cast by buildings, landscapes or large vehicles.
- The vehicle has crashed and the radar or camera mounting position has been changed.
- High light, such as oncoming headlights or direct sunlight.
- Dark surroundings such as night, dawn, dusk, Tunnels, etc.

warning

The following target radar/cameras are not recognized:

- Special vehicles, such as vehicles with a covered rear, damaged vehicles, or vehicles of irregular shape.
- When you encounter animals, traffic lights, walls and other unknown obstacles in your route.



- Some metal barriers, green belts, cement walls, etc.
- Road test facilities, cone drums, crash buckets, tripods, Small construction plates, etc.
- Static obstacles, such as traffic cones, buckets, traffic columns, warning triangle or other roadblock).
- Static objects, such as slow or stationary sweeper, rolling accident truck, large stones, Tripods, separation belts, pedestrians crossing the road, etc.

Lane Centering Control (LCC)

Function Overview

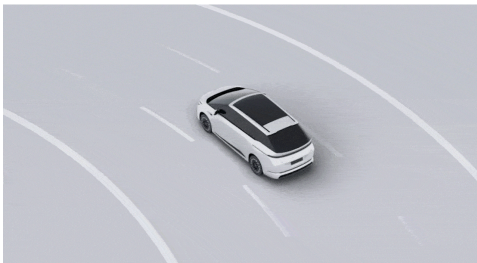

LCC is a comfort-oriented assisted driving function that helps the driver control the steering wheel and keeps the vehicle as centered as possible within the current lane.

When LCC is activated, it assists the driver in controlling the steering wheel and keeps the vehicle as centered as possible within the current lane on straight roads and roads with

Driving Assistance



standard curvature where lane markings on both sides are clearly visible.

i Tips

When LCC is activated, ALC can be used to assist with lane changes.

! warning

LCC is only a driver assistance function and cannot cope with all traffic, weather and road conditions. As the driver, you are responsible for driving safety. Please keep your hand on the steering wheel at all times, observe road conditions, and take over in time if you encounter danger. Do not rely on this function to control the vehicle, otherwise it may result in injury or death.

Status Indicator Light



LCC unavailable.



When the LCC activation conditions are met, LCC can be activated.



LCC activated.



LCC will exit with a delay.



Maximum speed limit value for LCC/NGP, with at least one of the functions activated.



Maximum speed limit value for LCC/NGP, with both functions deactivated.



A system malfunction is present.

Enable and Disable

On the touchscreen, go to “ → **Settings** → **XPILOT ASSIST** → **Driving Scenarios**” to turn LCC on or off.





Setting LCC

On the touchscreen, go to “→Settings→Driver Assistance→Driving Scenarios” to configure LCC.

- Voice Announcement Mode: You can set the voice announcement mode to Detailed or Simple. In Detailed Mode, the system will provide full voice announcement for driving assist vehicle actions and safety prompts; this mode is recommended for users who are not familiar with the functions. In Simple Mode, some driving assist voice announcement will be muted or replaced with an audible alert.
- Driving Assist Lights: You can set the driving assist lights to On or Off. When this is turned on and a driving assist function is activated, the exterior driving assist lights will illuminate in blue-green to alert surrounding vehicles and pedestrians.

Activate LCC

1. When LCC is available for activation, the  indicator on the instrument panel illuminates.
2. You can activate LCC using the shift lever or the left Smart Drive control button. After activation, the  indicator on the instrument panel illuminates and a voice prompt is played.
 - Push the shift lever all the way down once to activate LCC.



- Press the left Smart Drive control button to activate LCC.



i Tips

LCC can be activated when the following conditions are met:

- The components related to LCC are functioning properly and the view is clear.
- The lane markings are clearly visible.
- The wipers are not set to high-speed wiping.
- The brake pedal is not being pressed.
- The vehicle speed meets the requirements:

- The vehicle speed is less than 100 km/h on urban roads or less than 130 km/h on urban expressways.
- There are no safety risks, including but not limited to:
 - The seat belt is fastened correctly.
 - Both hands are holding the steering wheel firmly.
 - All doors are closed.
 - Tire pressure is normal.
 - Functions such as ABS and AEB are not activated.
 - You are not driving while fatigued.

If any of the above conditions are not met, LCC cannot be activated.

Set the Maximum Cruising Speed

When LCC is activated, you can use the left scroll wheel on the steering wheel or the Speed Assistance System (SAS) to set the maximum cruise speed.

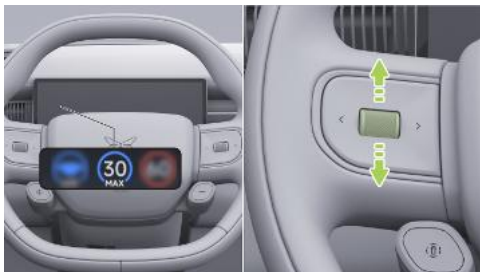

Scroll the wheel slowly to change the maximum cruise speed by 1 km/h, or scroll it quickly to change the maximum cruise speed by 5 km/h.

Alternatively, press the accelerator pedal to increase the vehicle speed, then press and hold the shift lever downward to set the current speed as the new cruise speed. If you do not press and hold the shift lever downward, releasing the accelerator pedal will cause the vehicle to decelerate to the previously set speed and continue cruising.

Set Following Distance

When LCC is active, you can use the left/right buttons on the left side of the steering wheel to set the following distance. There are 5 levels to choose from.

i Tips

When you set the following distance, the instrument panel will display the distance gear position.

Hands-off Detection Alert

While this function is in use, the system will continuously monitor whether the driver is holding the steering wheel. If the driver's hands are off the steering wheel for a certain period of time, the system will issue a **"Please keep hands on steering wheel"** message accompanied by an audible alert. At this time, the driver should hold the steering wheel again to clear the warning.

If the driver still does not hold the steering wheel, the system will progressively intensify the hands-off alerts through visual, audible, and



haptic warnings. When continuous hands-off reaches the specified time, the system will issue a **“Please take over the vehicle immediately”** warning. At this point, the driver must promptly respond to the takeover request and take control of the vehicle’s direction. Within the current driving cycle, if a manual takeover request is triggered due to prolonged hands-off, the driving assist functions will not be available for the remainder of this trip. You must shift back to P to clear the restriction.

warning

- The hands-off detection alert is an aid only function and does not replace the driver’s judgment on the time to take over, the driver should stay focused on driving and respond to the system’s alert message.
- The driver as the driver of the vehicle has the responsibility to drive safely, in the course of driving should comply with the provisions of traffic regulations, consciously keep the driving all the way with both hands

on the steering wheel, do not use any means to deceive the hands-off detection system.

Warnings and Takeover

warning

- If the vehicle issues a takeover request via SR interface, voice announcement, etc., take over immediately.
- In the event of a hazard, or in the event of a situation requiring a takeover, take over immediately and do not wait for the vehicle to issue a takeover request.

When LCC is active, you can take control in the following ways:

- Press the Accelerator Pedal: temporarily take over vehicle speed control.
- Press the Brake Pedal: Exit LCC.
- Push the Gear Selector Upward: Exit LCC.

If the vehicle’s current status does not meet the conditions for LCC activation, LCC will exit directly. Please be prepared to take over:



- Unclear lane markings.
- Turn the steering wheel.

Warnings, Cautions, and Limitations

Read all information related to LCC in this manual. You should understand these limitations before using this function.

LCC is designed to improve driving comfort and convenience and cannot handle sudden hazardous situations. The driver is responsible for remaining alert at all times, driving safely, and keeping control of the vehicle. Never rely on the system to handle sudden emergencies. Always pay attention to the road ahead and be prepared to take corrective action at any time; otherwise, serious injury or death may result.

warning

The LCC cannot handle all traffic, road conditions and weather, do not use or turn on the LCC in the following scenarios:

- Road with varying conditions, such as twists and turns.

- At the junction or divergence of the road.
- Roads that have been constructed or modified.
- When lane line disappears or disconnects.
- When the lane line is blurred, disappeared, or covered.
- A road with a sharp change in lane direction ahead, such as road divergence, lane merging, sudden lane width increase or decrease.
- Roads that are in poor condition, such as bumps, ice or slippery roads.
- Urban roads.
- At a traffic intersection.
- When the vehicle ahead steers or a vehicle is moving in front of the vehicle.
- A section where pedestrians or cyclists may be present.
- In bad weather, such as rain, snow, fog.



- When the vehicle is in poor condition, for example: Abnormal four wheel alignment, abnormal tire pressures, etc.

warning

The LCC does not respond fully in the following special conditions, complex road sections, weather or poor lighting conditions, be sure to look out for the environment and conditions. Be alert, always place your hand on the steering wheel and take over the vehicle at any time, including but not limited to:

- Special road conditions or complex road sections:
 - On a sloping road, or on a downhill section.
 - High speed turns or sharp turns.
 - The intersection has a road/road/zebra line/arrow scene.
 - No lane line or excessive wear or blockage, overwriting, or disappearance of lane lines.
- Temporary adjustment or rapid change due to road construction (e.g., lane forking, crossing or merging).
- Special lane change scenarios such as lane diversions, diverting, diverting zones, lane widening, etc.
- There are text or traffic signs on the surface of the road or dense text, traffic signs, asphalt oil, brake marks in the driveway, Tyre marks, ruts, etc.
- Driveway is too wide or narrow.
- The boundary of the road separated by ice cones, water horses, cement mounds, etc.
- Complicated road conditions:
 - On congested roads.
 - Pedestrians or cyclists' roads may appear.
 - When other vehicles are moving in front of the vehicle.
 - Suddenly a vehicle quickly changes lanes close to the front of the vehicle.



- When the vehicle ahead leaves the lane.
- The vehicle in front is blocking the camera's view or blocking the lane line.
- Large vehicles such as trucks, buses, etc. are on the side or in front.
- Poor weather or lighting conditions:
 - Objects or landscape features are projected onto the driveway to form large shadows.
 - When bright light, such as oncoming headlamp light or direct sunlight, prevents the camera from seeing its sights.
 - Windshield glass blocks the camera's field of view (mist, dirt, stickers, etc.). -
 - When there is a large lateral air flow or high wind on one side of the vehicle.
- Radar or camera restricted:
 - Radar restricted.
 - Camera restricted.

- Radar or camera blocked (dust, cover, etc.) or poor weather conditions (e.g. heavy rain, heavy snow, heavy fog).

warning

The LCC cannot fully identify and respond to the following environments and targets, it is important to pay attention to the environment and road conditions, take over the vehicle in a timely manner in the following scenarios to ensure safe driving. This includes, but is not limited to:

- Reliance on the system.
- Used when lane lines are not clear or light conditions are poor.
- Used in environments where pedestrians, cyclists or animals are heavy.
- Remove both hands from the steering wheel.
- Line of sight off the road.
- When there are guardrails, barriers or curb stones on one side of the road.



- The LCC will occasionally be able to assist the vehicle when secondary steering is not required or when you do not intend to steer, due to lack of clarity and irregularity in the lane line or other lines or objects on the surface of the lane that resemble a lane line, and you should take over the vehicle in time.

The above warnings, cautions, and limitations do not cover all conditions that may affect the normal operation of LCC.

Auto Lane Change (ALC)

Function Overview

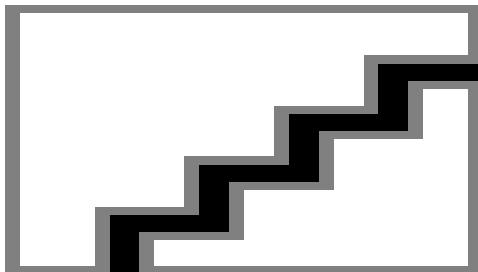

When LCC / NGP is activated and the turn signal is switched on, ALC can assist the driver in changing lanes.

i Tips

2024 X9 model: High speed road, ALC available speed is 15~135km/h, city road, ALC available speed is 15~100km/h.



warning

ALC is only a driver assistance function and cannot cope with all traffic, weather and road conditions. As the driver, you are responsible for driving safety. Please keep your hand on the steering wheel at all times, observe road conditions, and take over in time if you encounter danger. Do not rely on this function to control the vehicle, otherwise it may lead to injury or even death.

Enable and Disable

On the touchscreen “ → **Settings** → **XPILOT ASSIST** → **Driving Scenarios**” screen, you can enable/disable Auto Lane Change.

Using ALC



1. Check the surrounding environment and make sure it is safe to change lanes.
2. Turn on the turn signal/lane change indicator for the corresponding side.
3. If the conditions for an ALC lane change are met, ALC will assist the driver in changing lanes. If the conditions are not met, a prompt will be displayed via the SR screen; see .



i Tips

- The ALC can only change lanes one at a time, to change lanes again, switch on the opposite side of the traffic light/turn signal again.
- ALC cannot change lanes across lines.
- Once the ALC is initiated, it will look for the right time for the scene to change lanes, and when it is canceled, The SR screen displays the “**lane change canceled**” as a reminder.
- The traffic/turn signals will switch off automatically when the lane change is completed or canceled using the ALC.

Warnings and Takeover

! warning

- If a vehicle issues a takeover request via the SR interface, voice broadcast, or other means, takeover should be initiated immediately.
- If a hazard is detected, or a situation arises requiring takeover, takeover should be

initiated immediately. Do not wait for the vehicle to issue a takeover request.

After ALC is activated, you can cancel the lane change using the following operations:

- Turn the steering wheel: Cancel the lane change and temporarily takes over steering. When conditions are met again, LCC will reactivate.
- Depress the brake pedal: Cancel the lane change and exit LCC.

Warnings, Cautions, and Limitations

ALC is a driver assistance function and does not provide autonomous driving. When ALC is activated, the driver must continuously monitor the safety of the lane-change environment and be ready to take over the vehicle immediately if there is any potential danger.

ALC is designed to enhance driving comfort and convenience and cannot handle sudden hazardous situations. The driver is responsible for remaining alert at all times, driving safely, and



keeping control of the vehicle. Do not rely on the system to handle sudden emergencies. Always observe the road ahead and be prepared to take corrective action at any time, otherwise serious injury or death may result.

ALC may unexpectedly deactivate at any time for unknown reasons. Always monitor road safety conditions and be prepared to take appropriate action. The driver is always responsible for lane-change safety.

warning

Please read all the information about ALC in this manual. You should understand these limitations before using the function.

- ALC cannot handle all traffic, weather, and road conditions. Do not use it in inclement weather (such as rain, snow, or fog) or on roads where pedestrians or cyclists may be present.
- Do not use ALC when there are vehicles in front of or to the side of your vehicle, or in

adjacent lanes. Using ALC in this situation may result in a collision with other vehicles.

- If another vehicle is changing lanes simultaneously with ALC and the lane it is about to enter is the same as the lane your vehicle is about to enter, the function cannot avoid the risk of a collision. The driver must always observe the lane-changing environment for safety and intervene in vehicle control in a timely manner to avoid a collision. The driver is fully responsible for safe lane changes.
- Do not use ALC when the vehicle is in poor condition, such as with abnormal wheel alignment or abnormal tire pressure.
- Do not use ALC on highways or other roads at ramps, merging points, or diverging points.
- Use ALC with caution when turning, as the system may not support lane change assistance.
- Do not use ALC on city roads or in situations with variable road conditions.



- Do not use ALC on winding roads with sharp bends, or on bumpy, icy, or slippery surfaces, as the system cannot reliably provide lane change assistance under these conditions.
 - ALC may occasionally misinterpret lane change conditions as disallowed, requiring manual lane change.
 - In areas with heavy traffic, ALC may not accurately detect lane change conditions; use ALC with caution.
 - Do not use ALC on roads with solid lane markings or other lane change restrictions.
 - When using ALC, if another vehicle approaches rapidly, the driver must immediately take over; ALC cannot prevent potential collisions.
 - Do not use ALC when there are other vehicles in your blind spot to the side or rear of your vehicle, or in your lane when changing lanes.
- When the road has a sharp curve, or the road conditions are poor, such as bumpy, wet, or icy surfaces.
 - On a sloping road.
 - On a road where pedestrians or cyclists may be present.
 - In darkness (poor lighting conditions) or with poor visibility (due to heavy rain, snow, fog, etc.).
 - When strong light (such as oncoming headlights or direct sunlight) obstructs the camera's view.
 - When a vehicle ahead obstructs the camera's view.
 - When the windshield obstructs the camera's view (due to water vapor, dust, or stickers).
 - When lane markings are excessively worn, obscured, or covered; when old and new lane markings overlap; or when lanes have been temporarily adjusted or rapidly changed due to road construction (e.g., lane branching, crossing, or merging).



- Objects or landscape features cast large shadows on the lane.
- Warning cones, signs, or other objects are placed on the road surface.
- Radar is limited.
- Radar or cameras are obstructed (dust, covering, etc.), or weather conditions are adverse (such as heavy rain, heavy snow, dense fog).
- Strong lateral airflow or winds to one side of the vehicle can affect performance; ALC is not suitable in such weather.

The above warnings, cautions, and limitations do not cover all conditions that may affect the normal operation of ALC.

Intelligent Driving Lights

Introduction



After the ADAS Indicator Light feature is enabled and the ADAS functions are activated, the ADAS indicator lights will illuminate in blue-green simultaneously to alert vehicles and pedestrians outside the car.

i Tips

After the intelligent driving status lights are activated, when the turn signals are turned



on for lane changes or turning, the intelligent driving lights on the side mirrors and tailgate revert to the turn signal function and flash yellow.

Intelligent Driving Lights can be illuminated when a function is active (such as APA).

Operation

On the touchscreen, in the “ → **Settings** → **XPILOT ASSIST** → **Driving Scenarios**” interface, you can turn the Driving Assist Lights function on or off.

Tips

- To enable the Intelligent Driving Lights function, you must first log in to your personal account and pass the driver assistance test.
- In driving scenarios, the Intelligent Driving Lights can be illuminated only when a function is active (such as LCC, NGP, or Space-to-Space) and the Intelligent Driving Lights function is turned on in the touchscreen. In parking scenarios, the



Front&Rear Distance Warning

Function Overview

When parking or driving at low speeds, the ultrasonic sensors can detect the distance between the vehicle and surrounding obstacles, and provide reminder via the SR interface and an audible alert.

caution

- When a red bar is displayed, it indicates that an obstacle is very close to your vehicle and you need to be extra careful.
- As the distance between the vehicle and the obstacle decreases, the frequency of the warning sound will gradually increase.

Tips

- When the vehicle is in D gear, the radar will only issue a warning if the speed is less than 12 km/h; when the vehicle is in R gear, the radar warning has no speed limit.

- Even if the obstacle is relatively soft (such as tall, thin weeds) and will not damage the vehicle, the radar warning will still issue a warning.

Warnings, Cautions, and Limitations

warning

In the following scenarios, radar early warning systems may not function properly:

- Radar is limited.
- The vehicle approaches the obstacle at a relatively high speed.

The above warnings, cautions, and limitations do not cover all conditions that may affect the normal operation of radar warnings.



Advanced Parking Assist (APA)

Function Overview

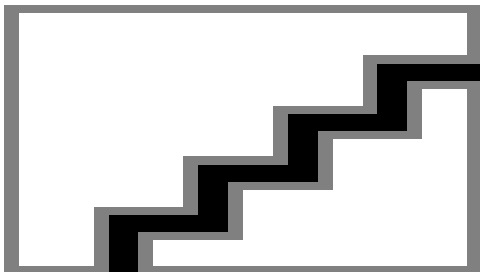

APA can assist the driver with parking into and exiting outlined and non-outlined perpendicular spaces, parallel spaces, angled spaces, and dead-end spaces, and supports the following activation methods:

- Touchscreen
- "Remote Key"
- Mobile key

warning

APA is only a driver assistance function and cannot cope with all traffic, weather and road conditions. As the driver, you are responsible for driving safety. Please keep your hand on the steering wheel at all times, observe road conditions, and take over in time if you encounter danger. Do not rely on this function to control the vehicle, otherwise it may lead to injury or even death.

Status Indicator Light



APA available



APA activated



APA unavailable



Enable and Disable

On the touchscreen, go to “ → **Settings** → **Driving Assist** → **Parking Scenarios**” to turn APA on or off.

Parking Speed Style Settings

On the touchscreen, go to “ → **Settings** → **Driving Assist** → **Parking Scenarios**” to set the parking speed style. After the setting is completed, the vehicle will park in and pull out using the selected speed style.

Using APA

1. Using any of the following methods, the “**Real-time VR Assist**” interface will enter Parking Mode:
 - Automatic switching. When the vehicle enters an environment such as an underground garage, “**Real-time VR Assist**” automatically switches to Parking Mode.
 - Tap “**I Want to Park**” on the touchscreen.
 - Directly say “**Hey XPENG, I want to park**”.

- When a parking space icon appears on the SR interface, stop the vehicle and shift to R.
2. Drive to look for the target parking space.

Tips

- When looking for a parking space, please keep the lateral distance between your vehicle and the parking space between 1 and 2 meters.
 - When searching for a parking space, the vehicle speed should not exceed 24 km/h.
3. When the target parking space is highlighted, press the brake pedal and tap the target parking space on the touchscreen to select it.



4. You can then park into the space using one of the following methods:
- Touchscreen: Tap **“Start Autopark”** on the touchscreen, then release the brake pedal.

i Tips

When the parking card displays the side offset option, confirm the side offset before clicking **“Start Parking”**.

- Remote key: Shift to P, exit the vehicle and close all doors, then press and hold the parking button on the remote key. After the exterior mirrors fold and the hazard warning lights turn on, double-press the parking button on the remote key.
- Phone key: Shift to P, exit the vehicle and close all doors, open the Auto Parking module in the mobile App, tap **“Remote Parking”**. After the exterior mirrors fold and the hazard warning lights turn on, tap **“Start Parking In”**.



i Tips

- After parking using the remote key/ phone key, the vehicle automatically shifts to P gear and locks, disabling the power.
 - When parking using the remote key/ phone key, the smart key/phone must remain near the vehicle; otherwise, the function will disengage.
 - When parking using the phone key, you are allowed to open the doors/trunk to retrieve items within five minutes of pausing remote parking. After retrieving the items and closing the door, you can click to continue remote parking.
- Parking in after exit: Tap **“Remote Parking”** on the touchscreen to bring up a pop-up window. After selecting the start method, occupants may exit the vehicle with the phone and remote key. The vehicle will turn on the hazard warning lights and then begin parking in automatically.

If **“Automatic parking is started after leaving the vehicle”** is selected, occupants may exit the vehicle with the phone and remote key, close all doors after exiting, and then keep a certain distance from the vehicle. The vehicle will turn on the hazard warning lights and then begin parking in automatically.

If **“After leaving the vehicle, confirm with your phone to start parking”** is selected, occupants may exit the vehicle with the phone and remote key, close all doors after exiting, and then trigger the function using any of the following methods:

- Cover the side-rear camera on the fender area for 3 seconds; the vehicle will turn on the hazard warning lights and then begin parking in automatically.

i Tips

This method depends on ambient brightness; if environmental conditions do not support it, the vehicle's



infotainment system will not provide a warning. **"This feature cannot be initiated by obstructing the camera"**, please activate it using the app.

- Tap the App notification or press the "Charge Port Open/Close & Parking" button on the remote key once to activate the function; the vehicle will turn on the hazard warning lights and then begin parking in automatically.

Tips

- Before using the "Park Away" feature, please ensure that notification permissions are enabled on your mobile app.
- After parking begins, please keep an eye on the surrounding environment of the vehicle, keep your phone's Bluetooth on, and wait until the vehicle is powered off and locked before leaving.

Warnings and Takeover

warning

- If the vehicle issues a takeover request via instruments, voice broadcast, or other means, takeover should be initiated immediately.
- If a hazard is detected, or a situation arises requiring takeover, takeover should be initiated immediately. Do not wait for the vehicle to issue a takeover request.
- Before parking in a space using the remote key/mobile app, please make sure no one is inside the vehicle.
- When using the exit parking method, before getting out of the car and closing the door, please check if any children or other important items are left in the back seat.

When APA is active, it can be paused by the following methods:

- Touchscreen parking: Press the brake pedal at any time to pause APA.



- Remote key parking: Briefly press any button on the smart key.
- Mobile key parking: Tap the “**Pause**” button on the parking page in the mobile App.

After confirming safety, APA can be resumed by the following operations:

- Touchscreen parking: Tap “**Continue**” on the touchscreen.
- Remote key parking: Double-press the parking button on the remote key.
- Mobile key parking: Tap “**Continue**” in the mobile App.

APA will exit in any of the following situations:

- The steering wheel is turned manually.
- The brake pedal is pressed while shifting gears.
- APA remains paused for more than 30 seconds without being resumed, or, when using Remote Parking via the mobile phone, it remains paused for more than 5 minutes without being resumed.

- Opening a door, pressing the accelerator pedal, or pressing the brake pedal causes APA to be paused a total of 3 times.
- Remote Parking: To pause parking, tap the vehicle lock button in the mobile App, press any button on the remote key, or pull a door handle.

Warnings, Cautions, and Limitations

warning

Do not use APA in the following scenarios:

- The road is a ramp.
- One or more ultrasonic sensors, the Surround Camera is dirty or obstructed (e.g. sludge, snow or water hanging).
- Poor weather conditions (e.g. heavy rain, heavy snow, heavy fog, etc.).
- The road surface is uneven, icy or slippery.
- Kerb material is not a stone or the curb cannot be detected.



- There are poor surfaces (e.g., cliffs, high platforms, sidewalks facing the street, etc.).
- Fitted with anti-slip chains or spare wheels.
- The loaded object protrudes from the vehicle.
- Either side of the left or right exterior mirrors is damaged or in an incorrect position.
- Parking spaces on narrow streets, or narrow parking spaces.
- Modifications to the vehicle or vehicle repairs carried out at a non-Xpeng Automobile Service Center affect the normal functioning of the vehicle.

warning

In the following scenarios, the APA may be unable to take safety measures and should immediately take over the vehicle:

- When the SR interface sends you a takeover request.
- When APA unexpectedly exits.

- When encountering vehicles, pedestrians, or objects during parking, the vehicle fails to automatically avoid or brake in a timely manner.

warning

APA may have the following situations, please note the takeover:

- Obstruction above and above exterior mirror height.
- Dangling, small, and small-width obstructions.
- A target in a camera or radar blind spot.
- Pedestrians or animals.

The above warnings, cautions, and limitations do not cover all conditions that may affect the normal operation of APA.



Remote Vehicle Summons

Function Overview

You can use the remote key / mobile key to move the vehicle forward or backward, making it easier for the vehicle to enter or exit narrow parking spaces where getting in or out of the vehicle is difficult.

Tips

The linear summoning function has an obstacle avoidance feature; it will automatically pause if it encounters an obstacle.

warning

Direct Summon is only a driver assistance function and cannot handle all traffic, weather, and road conditions. As the driver, you are responsible for your driving safety. Do not rely on this function to control the vehicle, otherwise it may lead to injury or even death.

Enable and Disable

On the touchscreen in the “”
→**Settings**→**Driving Assist**→**Parking Scenarios**” interface, you can turn APA on or off.

Remote Vehicle Summon via Key

1. Press and hold the parking button on the remote key. The exterior rearview mirrors will fold, and the hazard warning lights will turn on.
2. Press and hold the lock button on the remote key to move the vehicle forward, and press and hold the unlock button to move the vehicle backward.
3. After the vehicle has entered or exited the parking space, double-press any button to exit the function.



Remote Vehicle Summon via App

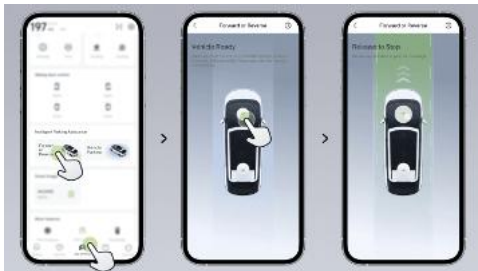

1. Open the mobile App and tap **“Forward or Reverse”**. The exterior rearview mirrors will fold, and the hazard warning lights will turn on.

i Tips

Usage condition: The XPENG Motors app needs to be upgraded to V5.14 and above.

i Tips

- When the current network environment is good, the mobile phone app will

automatically launch 360 image, but there is a delay in the network signal, the actual situation may be different from the display in the mobile phone app. Observe the surrounding parking environment.

- When 360 camera is activated, when the vehicle encounters an obstacle in the forward direction, the corresponding azimuth radar alert is displayed in the phone app according to the distance of the obstacle:
 - The distance is greater when white is displayed.
 - Red is displayed with a very close distance.
 - The distance from the nearest obstacle is also displayed as a numerical value in the front and rear of the vehicle.
2. Press and hold the switch to move the vehicle forward or backward. Release the switch and the vehicle will stop moving.



Parking Assistance

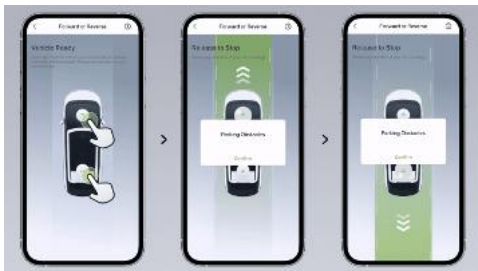

3. While the vehicle is moving forward or backward, you can follow the prompts in the mobile App. After reading and understanding the safety statement, tap “Confirm” to disable the vehicle’s detection of side obstacles to allow passage in narrow environments.

caution

When side impact detection is switched off, there is a risk of a vehicle collision if you continue to use the straight line summon feature, so keep an eye on your surroundings. The “Forward/Reverse”

button can be released at any time to stop the vehicle and avoid a collision.

4. After the vehicle has entered or exited the parking space, tap Back to exit the function.

Warnings and Takeover

warning

In the event of a hazard or a situation requiring a takeover, the function should be suspended immediately and never wait for the avoidance to trigger.

Remote Vehicle Summons will exit in the following situations:

- The mobile key is too far from the vehicle.
- The Bluetooth connection between the mobile and the vehicle is lost.
- Obstacle avoidance is triggered three times during a single use.
- No command to move the vehicle forward or backward is given for more than 30 seconds.



Warnings, Cautions, and Limitations

warning

Do not use a straight call in the following scenarios:

- One or more ultrasonic sensors, the Surround Camera is dirty or obstructed (e.g. sludge, snow or water hanging).
- Poor weather conditions (e.g. heavy rain, heavy snow, heavy fog, etc.).
- The road surface is uneven, icy or slippery.
- The road is a ramp.

warning

In the following scenarios, Direct Summon may be unable to take safety measures, and you should take over the vehicle immediately:

- The system prompts you to take over the vehicle.
- During parking, you encounter vehicles, pedestrians, or objects and fail to actively

avoid them or bring the vehicle to a stop in a timely manner.

- Direct Summon unexpectedly exits.

warning

When using a linear summon, please do not perform the following actions:

- Look away from the vehicle.
- Parking relies entirely on direct line calls.

The above warnings, cautions, and limitations do not cover all conditions that may affect the normal operation of Remote Vehicle Summons.

Reversing Assist

Function Overview

Reversing Assist is a function that assists the driver in reversing along the original path. When entering challenging road conditions such as dead ends or narrow roads, you can use



Reversing Assist to exit and get out of the situation.

caution

The reversing function has an obstacle avoidance feature; it will automatically stop if it encounters an obstacle.

warning

Reverse tracking is only a driver assistance function and cannot cope with all traffic, weather and road conditions. As the driver, you are responsible for driving safety. Do not rely on this function to control the vehicle, otherwise it may lead to an accident.

Enable and Disable

On the touchscreen “ → **Settings** → **XPILOT ASSIST** → **Parking Scenarios**” interface, you can turn APA on or off.

Using Reversing Assist

1. Drive forward at a speed below 20 km/h. The system will automatically and silently memorize the latest valid path.
2. Bring the vehicle to a stop using the brake pedal and shift into R.
3. Tap the “**Reversing Assist** → **Start Reversing Assist**” button on the touchscreen.
4. The system will automatically reverse at low speed following the memorized valid path.

caution

- A drive path in D below 20km/h is likely to be recorded as a valid path up to 100m.
- Prior to activating follow-through, reversing, turning the steering wheel too far or driving on a hill will clear a valid route.

Warnings, Cautions, and Limitations

warning

Do not use follow-through reversing in the following scenarios:



- The road is a ramp.
- One or more ultrasonic sensors, the Surround Camera is dirty or obstructed (e.g. sludge, snow or water hanging).
- Poor weather conditions (e.g. heavy rain, heavy snow, heavy fog, etc.).
- The road surface is uneven, icy or slippery.
- There are poor surfaces (e.g., cliffs, high platforms, sidewalks facing the street, etc.).

warning

Following situations where a trailing reversing maneuver may not be safe, take over the vehicle immediately:

- The system prompts to take over the vehicle.
- When reversing unexpectedly exits.
- Vehicles, pedestrians and objects are encountered during reversing and automatic avoidance or braking is not completed in time.

warning

Take care of the takeover as you may experience the following when using trailing trails:

- Obstruction above and above exterior mirror height.
- Dangling, small, and small-width obstructions.
- A target in a camera or radar blind spot.
- Suddenly approaching a pedestrian or animal.

warning

When using the line-following reverse function, do not rely entirely on it for reversing.

The above warnings, cautions, and limitations do not cover all conditions that may affect the normal operation of Reversing Assist.



Forward Collision Warning & AEB (FCW & AEB)

Function Overview



The Forward Collision Warning function includes Forward Collision Warning (FCW) and Autonomous Emergency Braking (AEB). It can reduce the risk of a collision or the vehicle speed at the time of impact, thereby improving driving safety.

warning

The forward collision warning does not work when the vehicle is in reverse gear.

When the system detects a collision risk, it will issue a warning via the SR interface and an audible alert.

If the risk increases further and the driver does not brake or the braking force is insufficient, the vehicle will automatically apply the brakes to mitigate the severity of the collision.

warning

- For pedestrians, two-wheeled vehicles, FCW operates at speeds between 0 and 150 km/h.
- For vehicles, FCW operates at speeds of approximately 0 to 150 km/h.
- When the vehicle gives a warning, the driver should take immediate action and do not wait for AEB to intervene.



warning

- For pedestrians, two-wheeled vehicles, AEB operates at speeds between 0 and 150 km/h.
- For moving, stationary or slow moving vehicles, AEB operates at speeds of approximately 0 to 150 km/h.
- If AEB stops the vehicle, the vehicle will remain stationary for a short period of time and the driver should take the controlled action as soon as possible.
- During AEB intervention in the vehicle braking, the driver pressing the accelerator pedal may cause the brakes to be interrupted.
- The AEB function is disabled when the driver or passenger is not wearing a seat belt.

warning

- Forward collision warning is an assistive feature and cannot function in all driving situations, traffic conditions, weather, and

road conditions. It cannot replace focused driving and accurate judgment. The driver bears full responsibility for driving safety. Always observe road conditions while driving and never rely on forward collision warning to warn of or avoid potential collisions. Many factors can reduce or affect performance, leading to unnecessary, inaccurate, or invalid warnings, braking interventions, or missed warnings. Relying on forward collision warning to warn of and avoid potential collisions can result in serious personal injury or even death.

- Automatic emergency braking is not designed to prevent collisions. At best, it can only attempt to reduce the impact of a frontal collision by trying to decrease the vehicle's speed. Relying on automatic emergency braking to avoid a collision can result in serious personal injury or even death.



Status Indicator Light



Forward Collision Warning Off



Forward Collision Warning Malfunction

Enable and Disable

On the touchscreen, go to “ → **Settings** → **XPILOT ASSIST** → **Active Safety**” to turn Forward Collision Warning on or off. When the function is on, you can set the Forward Collision Warning sensitivity.

Warnings, Cautions, and Limitations

Before using Forward Collision Warning, the driver should read this section to understand the operating instructions and limitations of the function.

- The forward collision warning function may be limited or ineffective in the following scenarios; please do not rely on this function entirely:
 - Radar or camera limitations.
 - Darkness or poor visibility. For example, poor lighting conditions, heavy rain, heavy snow, dense fog, etc.
 - Strong light obstructing the camera's view. For example, oncoming headlights or direct sunlight.
 - Windshield obstructing the camera's view (water vapor, dust, or stickers).
 - A vehicle traveling in the wrong direction ahead. When the vehicle is traveling on a sharp curve or on a road with poor conditions.
 - A target suddenly appears. For example, another vehicle suddenly moves quickly or close to the front of the vehicle.
 - Insufficient target overlap (the overlap between the front width of the vehicle and the rear width of the vehicle in front).



- The driver brakes, depresses the accelerator pedal deeply, or makes rapid or large turns of the steering wheel.
- There are stationary vehicles at the entrance/exit of a curve. Driving around a curve, an adjacent vehicle suddenly slows down. A vehicle overtakes from the front at a curve.
- Changing lanes, passing a stationary target on the roadside or an overtaking vehicle. Changing lanes after the vehicle in front brakes.
- Vehicles passing speed bumps, drains, or metal gates in garages.
- Vehicles passing over elevated bridges, pedestrian overpasses, or under road signs.
- Vehicles passing over elevated bridge joints, or areas with metal guardrails on the roadside.
- Ahead are traffic lights, water jets from sprinkler trucks, splashing water, metal posts on the road, overhead steel pipes, floating plastic bags, rolling aluminum cans on the

road, underground parking garages, highway toll booths, manhole covers, etc.

The above warnings, cautions, and limitations do not cover all conditions that may affect the normal operation of FCW & AEB.

Blind Spot Detection & Lane Change Assist (BSD & LCA)

Function Overview

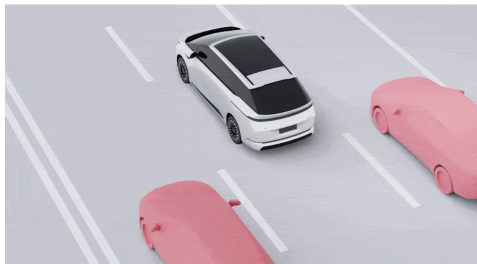



Blind Spot Detection (BSD) includes Blind Spot Detection and Lane Change Alert. It can monitor the lanes on both sides of the vehicle and provide a warning when there is a risk during lane changes.



When the gear selector is in D and the vehicle speed is above 10 km/h, if there is a vehicle in the blind spot or a vehicle rapidly approaching from the rear blind spot, the warning light on the corresponding exterior mirror will illuminate steadily. If you then switch on the turn signal/lane change indicator on that side, the warning

light on the exterior mirror will begin to flash to provide a warning.

warning

Blind Spot Safety Assist is merely a driver assistance feature and cannot handle all traffic, weather, and road conditions. It cannot replace a driver's focused driving and accurate judgment, nor can it replace the use of the interior and exterior rearview mirrors. As the driver, you are responsible for driving safety, and changing lanes safely is always the driver's duty. Do not rely on this feature to control the vehicle, as this may result in injury or even death.

Enable and Disable

On the touchscreen “ → **Settings** → **Driver Assistance** → **Active Safety**” screen, you can turn BSD on/off.



Warnings, Cautions, and Limitations

warning

In the following scenarios, BSD & LCA may not function correctly:

- Radar is limited.
- Sharp bend.
- When reversing.
- There is a large, moving metal object in the blind spot.

The above warnings, cautions, and limitations do not cover all conditions that may affect the normal operation of BSD & LCA.

Door Opening Warning (DOW)

Function Overview

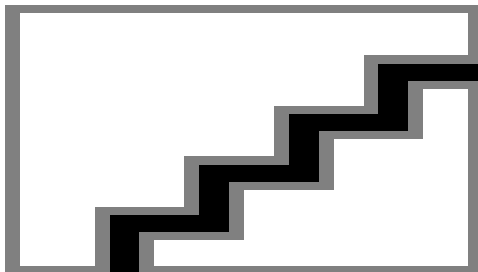

When there is a risk of collision while opening a door, DOW can provide a warning to the driver and passengers.

When the vehicle speed is between 0 and 5 km/h and a vehicle, pedestrian, or two-wheeled vehicle is approaching within the detection range at a certain speed, DOW will trigger a first-level warning, in which the warning light on



the corresponding exterior mirror will illuminate steadily.



If the driver or passengers still open the door on the corresponding side, a second-level alarm will be triggered, accompanied by a warning on the SR screen, an audible alert, and flashing door ambient lights.

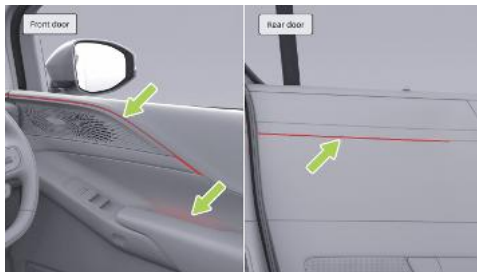

warning

DOW is merely a driver assistance function designed to remind occupants to be aware of the safety environment when opening vehicle doors. It cannot handle all traffic, weather, and road conditions, and cannot replace the driver's and passengers' visual observation, as well as the function of interior and exterior rearview mirrors. As the driver, you are responsible for driving safety. Do not rely on this function to control the vehicle, as this may result in injury or even death.



Enable and Disable

On the touchscreen “→**Settings**→**Driver Assistance**→**Active Safety**” screen, you can turn the DOW on/off.

Warnings, Cautions, and Limitations

warning

In the following scenarios, DOW may not function properly:

- Radar limitations.
- Smaller or stationary targets.
- The target vehicle is traveling too fast or is making a turning maneuver. For example, the target vehicle changes lanes to be directly behind this vehicle, or other vehicles suddenly change lanes and appear in the monitoring area directly behind this vehicle.
- Other vehicles and cyclists appearing directly behind this vehicle.
- The vehicle stopped at a bend or next to a wall.

The above warnings, cautions, and limitations do not cover all conditions that may affect the normal operation of DOW.

Rear Collision Warning (RCW)

Function Overview



When the vehicle is moving forward at a speed between 15 and 160 km/h and RCW detects that a vehicle behind may collide with your vehicle, it will warn the driver with audible and visual signals, and switch on the hazard warning lights



to remind the driver of the following vehicle to brake, helping to ensure driving safety.

warning

RCW is merely a driver assistance function and cannot handle all traffic, weather, and road conditions. It cannot replace a driver's focused driving and accurate judgment, nor can it replace the use of the interior and exterior rearview mirrors. As the driver, you are responsible for your driving safety. Do not rely on this function to control your vehicle, as this may result in injury or even death.

Enable and Disable

On the touchscreen “ → **Settings** → **Driver Assistance** → **Active Safety**” screen, you can turn RCW on/off.

Warnings, Cautions, and Limitations

warning

In the following scenarios, RCW may not function properly:

- Radar limitations.
- Smaller or stationary targets.
- The target vehicle is traveling too fast or is making a turning maneuver. For example, the target vehicle changes lanes to be directly behind this vehicle, or other vehicles suddenly change lanes and appear in the monitoring area directly behind this vehicle.
- Other vehicles and cyclists appearing directly behind this vehicle.
- The vehicle stopped at a bend or next to a wall.

The above warnings, cautions, and limitations do not cover all conditions that may affect the normal operation of RCW.



Reverse Automatic Emergency Braking (RAEB)

Function Overview

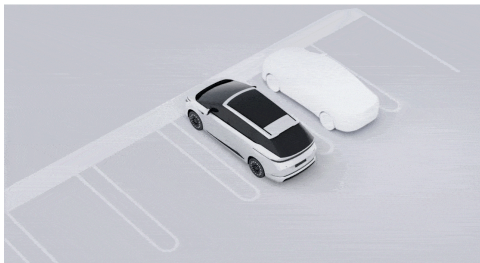

The RAEB function can detect collision risks behind the vehicle while reversing, issue a warning, and assist with braking.

When the gear selector is in R and the vehicle speed is between 0 and 18 km/h, if a pedestrian is approaching within the detection range at a certain speed and there is a risk of collision,

RAEB will provide a warning via the SR screen and an audible alert.

If the risk increases further and the driver still does not brake or the braking force is insufficient, RAEB will assist with braking to reduce or avoid injury caused by a collision.

warning

The RAEB function is a driving aid and may not function in all situations, nor is it a substitute for the driver's attention, who is required to reverse safely. Do not use the system when sight is obstructed and traffic conditions are difficult to observe, such as on a busy road or crossing multiple lanes, as the system may not accurately identify cyclists and pedestrians. So you must always be aware of your surroundings.

caution

Once the RAEB brake is parked, the brakes will be maintained for a period of time and the



driver should take over the vehicle as soon as possible.

Enable and Disable

On the touchscreen “→Settings→Driver Assistance→Active Safety” screen, you can turn RAEB on/off.

Warnings, Cautions, and Limitations

warning

RAEB may not function properly in all cases and may cause unnecessary, untimely or ineffective warnings for a variety of reasons. Or omit warnings, such as:

- Radar restricted.
- Large moving metal objects in blind spot area.
- The object to be detected moves too fast.

The above warnings, cautions, and limitations do not cover all conditions that may affect the normal operation of RAEB.

Rear Cross Traffic Alert (RCTA)

Function Overview

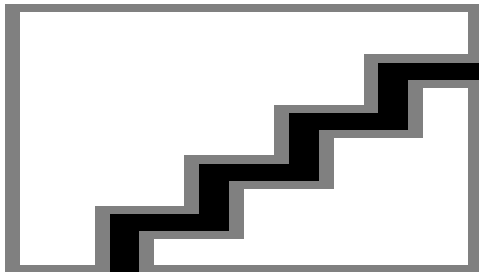

When rear visibility is limited while reversing, RCTA can alert the driver to vehicles approaching from the blind spots on both sides at the rear.

When the gear selector is in R or N and the vehicle is moving backward at a speed between 2 and 15 km/h, if a vehicle, pedestrian, or two-wheeled vehicle is approaching within the detection range at a certain speed and there is a



risk of collision, RCTA will activate and provide a warning via the SR screen and an audible alert.

warning

RCTA is merely a driver assistance feature and cannot handle all traffic, weather, and road conditions. It cannot replace a driver's focused driving and accurate judgment, nor can it replace the use of the interior and exterior rearview mirrors. Do not take risks simply because the system enhances comfort. Reversing safely is always the driver's responsibility. Do not rely on this feature to control the vehicle, as this may result in injury or even death.

Enable and Disable

On the touchscreen “ → **Settings** → **Driver Assistance** → **Active Safety**” screen, you can turn RCTA on/off.

Warnings, Cautions, and Limitations

warning

Do not use RCTA in the following scenarios:

- Limited field of vision.
- The traffic conditions are complex, such as roads with heavy traffic or crossing multiple lanes.

warning

In the following scenarios, RCTA may not function properly:

- Radar is limited.
- The target is moving too fast.
- There is a large, moving metal object in the blind spot.

warning

RCTA may encounter the following situations:

- The pedestrians and two-wheeled vehicles were not accurately identified.



The above warnings, cautions, and limitations do not cover all conditions that may affect the normal operation of RCTA.

Startup Safety Assist

Function Overview



Startup Obstacle Avoidance limits the vehicle's power response when starting up if an obstacle is detected in the direction of travel and the driver depresses the accelerator pedal too

quickly, in order to avoid a collision with the obstacle due to excessive acceleration.

warning

Start-up obstacle avoidance assist is merely a driver assistance function and cannot replace direct visual observation. Do not over-rely on it. When activated, it only limits vehicle acceleration to a certain extent; you still need to actively control the vehicle to stop, otherwise a collision can still occur. You are responsible for remaining vigilant, paying attention to the vehicle's starting environment, and always being aware of other road users; otherwise, serious injury or even death may result.

Enable and Disable

On the touchscreen “ → **Settings** → **XPILOT ASSIST** → **Active Safety**” screen, you can turn Startup Safety Assist on/off.



Warnings, Cautions, and Limitations

warning

The obstacle avoidance assist function does not always work in all situations. Various reasons can cause unnecessary, inaccurate, or invalid warnings, or omissions, such as:

- Radar is limited.
- There is a large, moving metal object in the blind spot.
- The target is moving too fast.

The above warnings, cautions, and limitations do not cover all conditions that may affect the normal operation of Startup Safety Assist.

Lane Departure Assist (LSS)

Function Overview

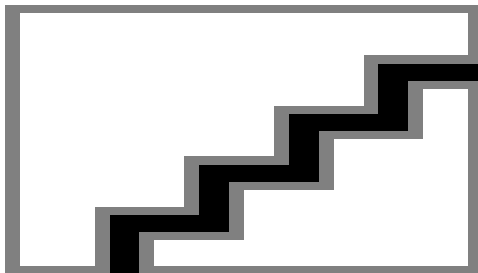

LSS includes Lane Departure Warning (LDW), Lane Keeping Assist (LKA), and Emergency Lane Keeping (ELK). It can warn against and correct unintentional lane departures, or perform emergency maneuvers to avoid potential side collisions.



warning

LSS is merely a driver assistance function and cannot handle all traffic, weather, and road conditions. It cannot replace the driver's focused driving and accurate judgment. As the driver, you are responsible for driving safety. Do not rely on this function to control the vehicle, otherwise it may result in injury or even death.

If Warning mode is selected, only LDW is enabled. If Intervention mode is selected, LDW, LKA, and ELK are all enabled:

- LDW: When the vehicle speed is between 60–150 km/h and the vehicle departs from the lane without the corresponding direction turn signal being activated, this function provides warnings via the SR interface, an audible alert, and steering wheel vibration, until the driver corrects the vehicle's position.

warning

LDW only provides an alert and cannot correct the vehicle back into the lane. Please correct the vehicle's position promptly when LDW issues an alert.

- LKA: When the vehicle speed is between 60–150 km/h and the vehicle departs from the lane without the corresponding direction turn signal being activated, LKA provides warnings via the SR interface and an audible alert, and intervenes in steering control to guide the vehicle back into the lane.
- ELK: When the vehicle speed is between 60–150 km/h and a collision with a curb, oncoming vehicle, or overtaking vehicle is imminent, ELK provides warnings via the SR interface and an audible alert, and intervenes in steering control to perform an emergency avoidance maneuver.

warning

- When the turn signal is on or the driver has a clear intention to turn (such as quickly



turning the steering wheel, braking, pressing the accelerator pedal deeply to accelerate, turning on the hazard warning lights, etc.), the lane departure assist function will not issue a warning or intervene in lane departure.

- Both the windshield wipers and hazard lights will suppress the activation of this function.

Setting LSS

On the touchscreen “ → **Settings** → **XPILOT ASSIST** → **Active Safety**” screen, you can set the mode and sensitivity of the lane support system.

Warnings, Cautions, and Limitations

warning

LSS may not function properly in the following scenarios:

Unusual or complex road conditions:

- Excessively worn lane markings, overlapping old and new markings, or rapid adjustments

or changes due to road construction (e.g., lane branching, crossing, or merging).

Poor weather conditions or lighting:

- When there is a strong lateral airflow or wind on one side of the vehicle.
- Darkness (poor lighting conditions) or poor visibility (due to heavy rain, snow, dense fog, etc.).
- Strong light (such as oncoming headlights or direct sunlight) obstructs the camera's field of view.
- Large shadows cast by objects or landscape features on the lane.
- Lane lines cannot be recognized or are recognized incorrectly due to lighting conditions, such as lane line glare caused by strong light, poor visibility due to inclement weather or nighttime, or insufficient light.

Camera obstruction:

- The camera is obstructed.



- When the camera is blocked (dust, covering, etc.).
- When there is a vehicle ahead that may obstruct the camera's view.

LSS may occur in the following situations:

- Issue a warning or apply the brakes when there is no risk of collision.

The above warnings, cautions, and limitations do not cover all conditions that may affect the normal operation of LSS.

Traffic Sign Recognition (TSR)

Function Overview

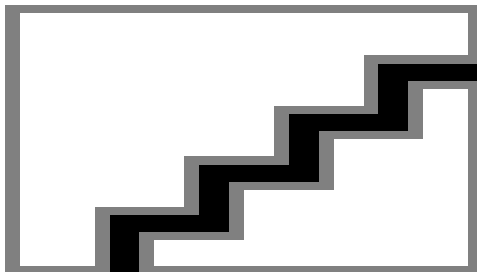

TSR can recognize speed limit signs on the road and obtain speed limit information from navigation, then display it on the SR interface, and will also provide a warning when the vehicle exceeds the speed limit.



"Speed Limit Reminder"

TSR can recognize road sign speed limits and speed camera speed limits, and will provide warnings using different icons:



Road sign speed limit



Speed camera speed limit



Exceeding road sign speed limit



No road sign speed limit

Tips

The signs that TSR can recognize include: speed limit signs, variable speed limit signs, speed limit cancellation signs, area speed limit signs, multi-lane speed limit signs, multiple

speed limit signs, and highway exit ramp speed limit signs.

Overspeed Warning

When TSR detects a road speed limit:

- In manual driving or with LCC assisted driving: when the road speed limit is ≥ 60 km/h and the vehicle speed exceeds the limit by approximately 20%, the speed limit icon on the instrument panel will flash 3 times as a warning.
- With XNGP/HNGP assisted driving: when the vehicle exceeds the speed limit by approximately 15%, the numeric value in the speed limit icon on the instrument panel turns red; when the vehicle exceeds the speed limit by approximately 20%, the numeric value turns red and the outer frame continuously flashes.

warning

TSR is only a driver assistance function and cannot cope with all traffic, weather and road conditions. As the driver of the vehicle, you are



responsible for driving safety. Do not rely on this function to control the vehicle, otherwise it may lead to injury or even death.

Warnings, Cautions, and Limitations

warning

In the following scenarios, TSR may not function properly:

- Radar or cameras are limited.
- When road or speed limit signs have been changed recently.
- When traffic signs are in poor condition.

The above warnings, cautions, and limitations do not cover all conditions that may affect the normal operation of TSR.

Speed Assistance System (SAS)

Function Overview

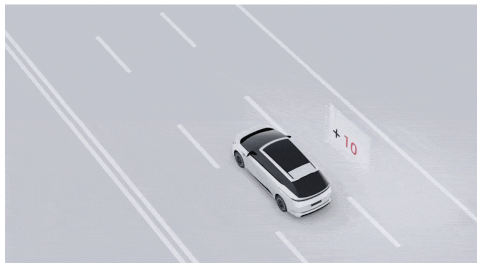

SAS can synchronize the maximum cruising speed with the road speed limit recognized by TSR.

warning

SAS is only a driver assistance function and cannot cope with all traffic, weather and road conditions. As the driver of the vehicle, you are responsible for driving safety. Do not rely on

Active Safety



this function to control the vehicle, otherwise it may lead to injury or even death.

Enable and Disable

On the touchscreen “ → **Settings** → **XPILOT ASSIST** → **Active Safety**” screen, you can set the assist mode of SAS.

Manual: When TSR recognizes new speed limit information, it will provide a reminder via the SR interface. At this time, you can push and hold the gear selector downward to set the cruising speed to the current road speed limit.

Automatic: When TSR recognizes new speed limit information, SAS automatically sets the cruising speed to the current road speed limit.

Warnings, Cautions, and Limitations

warning

SAS may not function fully or may provide inaccurate information in the following situations:

- Camera restrictions
- Road conditions or speed limits may have been changed recently, such as due to construction or traffic control.
- Traffic signs are in poor condition: damaged, faded, blurry, or not placed or set up as required.

The above warnings, cautions, and limitations do not cover all conditions that may affect the normal operation of SAS.



Driver Status Monitoring (DSM)

Function Overview

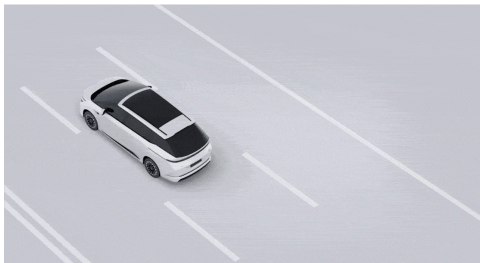

When the vehicle reaches a certain speed, the system uses the in-vehicle camera to continuously monitor the driver's condition, including fatigue, distraction, and making phone calls.

When the driver becomes fatigued or distracted, the system issues alerts via the instrument panel, the large-screen SR interface, and audible warnings. If the driver remains fatigued or

distracted for an extended period, the system will also provide alerts through steering wheel vibration. In manual driving scenarios, the system will additionally coordinate with the lane support system and the forward collision warning to alert the driver to collision risks earlier.

i Tips

When using advanced driver assistance systems such as Lane Centering Assist or Navigation Assist, the DSM (Driver Assist Management) will activate at speeds above 20 km/h; under manual driving conditions (without LCC/NGP), the DSM will activate at speeds above 50 km/h.

Enable and Disable

On the touchscreen “ → **Settings** → **XPILOT ASSIST** → **Active Safety**” screen, you can set whether enable or disable Driver Status Monitor during assisted driving or manual driving. The system default settings are: enabled during



assisted driving, and disabled during manual driving.

The sensitivity of Driver Status Monitor can be customized by the user, with three options: “**Low / Medium / High**”. The default setting is “**Medium**”.

caution

When fatigued and distracted, the in-vehicle camera will not record or share images, audio, or video.

warning

- Disabling DSM will prevent the system from monitoring and alerting drivers to fatigue or distraction, which could compromise driving safety. Please use caution when disabling it.
- Driver status monitoring is an auxiliary function. Do not rely on fatigue and distraction alerts to deal with all situations. Drivers must always maintain control of the vehicle and observe the road environment.



High-Voltage Components

Introduction

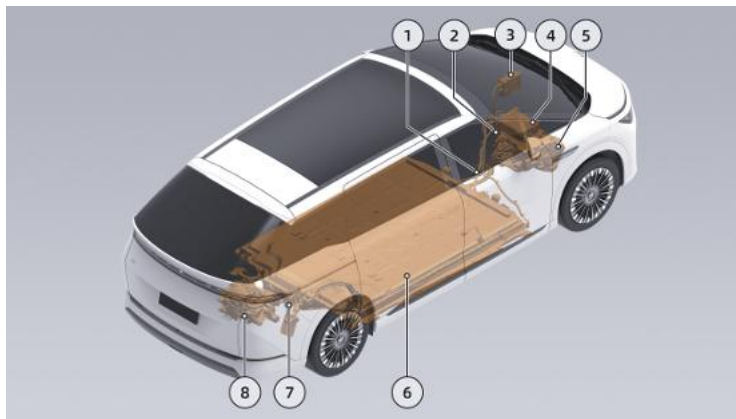

1. High-voltage wiring harness

5. Front electric drive system



2. air conditioner compressor	6. Traction battery
3. Heater	7. Charging port
4. On-board battery chargers/DCDC converters	8. Rear electric drive system*



warning

Do not touch or remove the high voltage harness or the high voltage components connected to the high voltage harness, or there is a risk of electric shock.



Charging Port Cover Open&Close

Charging Port Cover Switch

The charging port is located at the right rear side of the vehicle. When the vehicle is unlocked and the gear selector is in P, press the middle area on the left side of the charging port cover to open the charging port cover.



Press the switch to close the charging port cover.



i Tips

When the right sliding door is open, the charging port cover cannot be opened. Please fully close the right sliding door before operating the charging port cover. In addition, the charging port cover also cannot be opened while the right sliding door is in the process of opening or closing.



caution

Before closing the charging port cover, make sure there are no obstructions at the charging port to prevent damage to the cover.

Opening&closing the charging port cover via the touchscreen

- Tap  on the touchscreen to enter the Control Center interface, where you can open/close the charging port cover.
- Tap the charging port icon below the 3D vehicle model on the home screen of the touchscreen , or tap the hotspot icon in the charging port area on the 3D vehicle model, to open/close the charging port cover.

Tips

The hotspot icons on the 3D vehicle model are hidden by default. You need to tap the 3D vehicle model to display them.

Opening&closing the charging port cover via the mobile App

In the mobile App “XPENG” interface, you can open/close the charging port cover. Before opening, make sure the gear selector is in P.

Automatic Charging Port Cover Closing

The charging port cover will close automatically when any of the following conditions is met:

- The vehicle is locked after the charging gun is unplugged.
- No charging gun is plugged in and there has been no operation for a period of time.
- The gear selector is shifted out of P.

Charging Port Cover Open Reminder

After the charging port cover is opened, the instrument panel and the SR interface on the touchscreen will both indicate that the charging port cover is open.



i Tips

- After charging is complete, reinstall the sealing cap on the charging port to prevent foreign objects from entering.
- Do not close the charging port cover by pressing on the cover, to avoid damaging the charging port cover.

⚠ caution

When washing your car, avoid using a high-pressure water gun to spray water onto the charging port cover switch area, as this may cause the charging port cover to open.

Charging Port Cover De-Icing

In cold weather, the charging port cover may become frozen and fail to open. In this case, you must thaw it first.

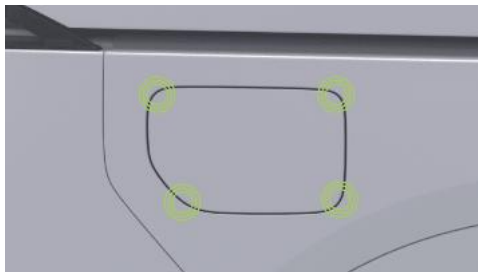

1. Gently tap the four corners of the charging port cover with an appropriate tool.
2. Place a hot towel that has been wrung out flat over the charging port cover to soften the ice.

If the charging port cover still cannot be opened using the above methods, contact an XPENG service center for assistance.

⚠ warning

- Do not use highly corrosive liquids and pour the charging flap to avoid damage to the paint.

Charging Guide



- Do not force the charging flap to damage the cap.

Slow Charging Station Operation

AC Slow Charging Port

The vehicle supports AC slow charging. You can charge the vehicle using an AC charging station or a portable charging gun.



Slow Charging Operation Guide

1. Open the charging port cover and remove the AC slow-charging port sealing cap.
2. Insert the charging gun vertically into the slow charging port. When you hear a “click,” it indicates that the charging gun is fully inserted.
3. Follow the instructions on the slow charging station (swipe a card or scan the QR code) to start the process; the vehicle will then begin charging.





4. To end charging temporarily, first tap the “End Charging” button on the touchscreen, and then remove the charging gun.
5. Reinstall the charging port cap and close the charging port cover.

warning

- Read the Charging/Discharge Precautions section carefully before performing quick charge operation.
- Charging or stopping must be done in strict accordance with the operating procedures of the charging pile. Do not plug or unplug the charge gun during charging.
- If a fault occurs during charging, the charging screen will pop up a fault indication, do not try charging again, contact the XPENG Automobile Service Centre immediately.
- In the event that the slow-charge gun fails to pull out, the gun can be unlocked using either the center screen emergency unlock

switch or the boot emergency unlock pull ring.

Emergency Release of Slow Charging Port

If the charging gun still cannot be removed after unlocking the vehicle several times, you can remove the charging gun using the following method:

On the touchscreen, go to “ → **Settings** → **Energy** → **Charging**”, then tap “**Unlock Charging Gun in Emergency**” to manually unlock and then remove the charging gun. If the vehicle is charging, unlocking the charging gun will end charging early. Confirm before proceeding.

Mechanical Unlock in Emergency

If the charging gun still cannot be removed after several attempts using the unlock in emergency button on the touchscreen, firmly push the charging gun in again and then remove it using the following method:

Charging Guide



1. Open the trunk, fold down the right-side seat backrest of the third row, locate the rear trunk service cover, and use an appropriate tool to open the service cover.



2. Locate the slow charging port unlock in emergency pull ring, pull the ring to unlock, and then remove the charging gun.



caution

- After the vehicle has finished charging and the CID exits the 'charging/heating up' status display. Only use the emergency unlock pull ring to unlock the charge gun.
- The emergency unlocking of the ring by the charging port is suitable for use in emergency situations and frequent use may damage the emergency unlocking ring or the charging device.
- If you cannot unlock the charge gun using the emergency unlock ring of the charging



port, please contact the XPENG Service Center in a timely manner.

Fast Charging Station Operation

DC Charging Port

This vehicle supports DC charging. You can charge the vehicle using a GB/T DC charging station or an XPENG ultra-fast charging station.



Fast Charging Operation Guide

1. Open the charging port cover and remove the DC charging port cap.



2. Insert the charging gun vertically into the DC charging port. When you hear a “click,” it indicates that the gun is fully inserted.



3. Follow the instructions on the DC charging station (swipe a card or scan the QR code) to start the process; the vehicle will then begin charging.



4. To end charging temporarily, first tap the "End Charging" button on the touchscreen, and then remove the charging gun.



5. Reinstall the charging port cap and close the charging port cover.

warning

- Read the Charging/Discharge Precautions section carefully before performing quick charge operation.
- Charging or stopping must be done in strict accordance with the operating procedures of the charging pile. Do not plug or unplug the charge gun during charging.

- If a fault occurs during charging, the charging screen will pop up a fault indication, do not try charging again, contact the XPENG Automobile Service Centre immediately.

Schedule Slow Charging

Function Overview

The vehicle is equipped with a slow charging appointment function, allowing you to preset the charging start time and end time in advance via the touchscreen and the mobile App. When the preset charging start time is reached, the vehicle will start charging automatically. When the preset end time or the preset charging limit is reached, the vehicle will automatically stop charging.

Tips

You can schedule charging at night using the scheduled charging function to take advantage of off-peak electricity rates and save on charging costs.



Tips

The schedule charging function cannot be set while the external discharge function is in use.

Set via Touchscreen

In the touchscreen “ ”

→**Settings**→**Energy**→**Charging**” interface, you can enable slow charging appointment and set the charging time.

Tips

Before enabling the slow charging reservation function on the central control screen, please ensure that the charging station reservation function is disabled on the mobile app; otherwise, the reservation will fail.

caution

- When preheating with a low-temperature battery, lock the vehicle after inserting the charger gun to prevent it from being pulled out by others.

- During charging, scheduled charging cannot be switched on, to switch on, end charging first.
- To use the scheduled charging function, insert the charging gun before the scheduled charging time, otherwise scheduled charging may fail.
- Xpeng Home Charging Pile also supports the Pile Scheduled Charging function, while opening the Home Charging Pile Scheduled Charging function and the Vehicle Scheduled Charging function, may cause the Scheduled Charging function to fail. It is recommended to switch on a scheduled charging function at the same time.

Set via the Mobile App

In the mobile App “**XPENG**→**Settings**→**Charging Management**” interface, you can enable slow charging and set the charging time.

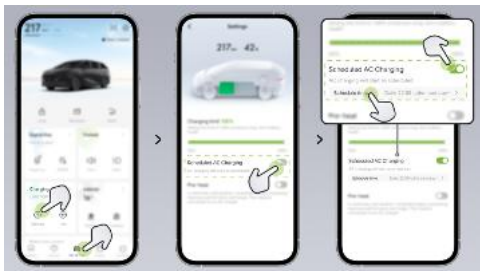

Schedule Charging Operation

1. Preset the charging start time and end time in advance via the touchscreen or the mobile App.
2. Open the charging port cover and remove the AC slow-charging port sealing cap.

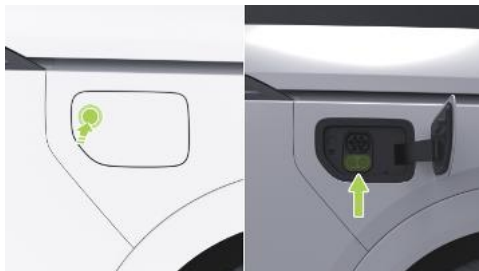

3. Insert the charging gun vertically into the slow charging port. When you hear a “click,” it indicates that the charging gun is fully inserted.



4. Operate the slow charging station according to the instructions (swipe a card or scan a code as required).



5. When the preset charging start time is reached, the vehicle will start charging automatically. When the preset end time or the preset charging limit is reached, the vehicle will automatically stop charging. If you need to start charging earlier, tap the “Start Charging” button on the touchscreen to start charging the vehicle.



- To end charging temporarily, first tap the "End Charging" button on the touchscreen, and then remove the charging gun. After unplugging the charging gun, refit the charging port cap and close the charging port cover.

warning

- Read the Charging/Discharge Precautions section carefully before performing quick charge operation.
- Charging or stopping must be done in strict accordance with the operating procedures of the charging pile. Do not plug or unplug the charge gun during charging.
- If a fault occurs during charging, the charging screen will pop up a fault indication, do not try charging again, contact



the XPENG Automobile Service Centre immediately.

- In the event that the slow-charge gun fails to pull out, the gun can be unlocked using either the center screen emergency unlock switch or the boot emergency unlock pull ring.

Preheating Before Fast Charging

Function Overview

The traction battery's charging speed is closely related to its temperature; if the battery temperature is too high or too low, the charging speed will be affected. Before charging the vehicle, keeping the battery temperature within the appropriate range in advance can effectively shorten the charging time.

Function Settings

On the touchscreen, go to “ → **Settings** → **Energy** → **Charging**” to enable

“**Temperature Control before Fast Charging**” or tap “**Keep Battery Temperature Now**”.

- **Temperature Control before Fast Charging:** After this function is enabled, when the in-vehicle navigation destination is set to a fast charging station, the vehicle will control the traction battery temperature within the optimal charging range to shorten charging time.
- **Keep Battery Temperature Now:** After you tap this manually, the system will immediately adjust the traction battery temperature.

Tips

- Use the battery keep-warm function before fast charging to reduce charging time but also to consume some power battery power if needed.
- Recommended charging operating ambient temperature: 0 to 45°C. When operating at temperatures below 0 °C, it is recommended to use the warm-up function before



charging, otherwise it will cause slow charging.

Low-Temperature Battery Preheating

Function Overview

Battery performance is closely related to temperature; an appropriate battery temperature can improve output efficiency and service life. In cold weather, after the vehicle is powered on, the battery will consume its own energy to raise its temperature, which will reduce the vehicle's driving range.

The low-temperature preheating function can increase the battery temperature using power from the slow-charging station when the vehicle is connected to the slow-charging gun, extending the driving range in cold environments. When the traction battery reaches an appropriate temperature or the preset battery preheating end time is reached, the low-temperature preheating function stops automatically.

Set via Touchscreen

On the touchscreen, in the “ → **Settings** → **Energy** → **Charging**” screen, you can turn the low-temperature battery preheating on or off and set the preheating end time.

Tips

Preheating of the low temperature battery will slightly increase the charge pile consumption and use it as needed. Use the vehicle as soon as possible after the warm-up is complete, prolonged parking will reduce the heating effect.

caution

- When using low-temperature battery preheating, plug in the gun and then lock the vehicle to prevent others from unplugging the charging gun.
- If activation fails, check whether all conditions for enabling the function are met.



In case of any abnormal situation, contact an XPENG service center.

Set via the Mobile App

In the mobile App “XPENG→More Functions→Battery Preheating” screen, or the “XPENG→Settings→Charging Management” screen, you can turn the low-temperature battery preheating on or off and set the preheating end time.



Charging Limit

Function Overview

The vehicle is equipped with a charge limit setting function. You can set the traction battery charge limit via the touchscreen and the mobile App. When the preset charge limit is reached, the vehicle will automatically stop charging.

Set via Touchscreen

On the touchscreen, in the “→Settings→Energy→Charging” screen, you can set the charge limit.

Tips

- To ensure charging speed and to extend battery life, it is recommended that when charging, Select the **“best button for the charging limit”**.
- When battery health protection is switched on, the charging limit will revert to the default value when the vehicle is recharged,



and the charging limit is 90% for models equipped with a 3-way lithium battery. The charging limit for models equipped with a lithium iron phosphate battery is 100%.

Set via the Mobile App

In the mobile App “**XPENG**→**Settings**→**Charging Management**” screen, you can slide the progress bar to set the charge limit.

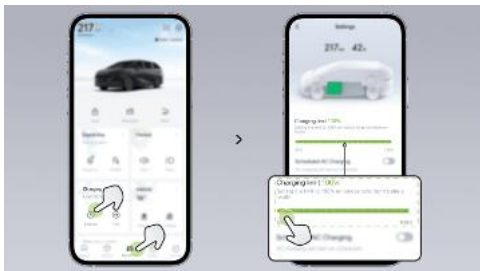

Vehicle to Load (V2L)

Function Overview

The vehicle is equipped with an slow-charge discharge function. After connecting the discharge device to the AC slow-charging port, it can supply power to 220 V household appliances such as lighting or low-power ovens. Maximum power: 6 kW.

When using the Vehicle to Load function, pay attention to the vehicle's remaining state of charge to avoid insufficient remaining range for the return trip.

V2L Operation

1. Open the charging port cover and remove the AC slow-charging port sealing cap.

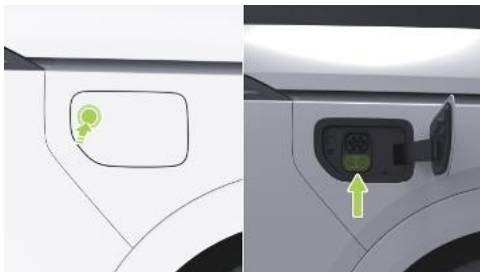

2. Insert the 16 A power strip three-prong plug into the V2L discharge device.



3. Insert the V2L discharge device into the AC slow-charging port and make sure it is fully seated.

i Tips

External discharge equipment (such as discharge outlets) is not standard equipment and must be purchased separately.

4. On the touchscreen, tap the “ → **Settings** → **Charging & Discharging** → **Power Supply**” screen to set the power limit.

i Tips

The vehicle automatically stops discharging externally when the power battery charge falls below the set supply limit.

5. When you need to stop discharging, first tap the “**Stop Power Supply**” button on the touchscreen, then unplug the discharge device, reinstall the charging port sealing cap, and close the charging port cover.



warning

- When the discharge job is to be completed. Please click the “**End Power**” button on the central control screen first. Then unplug the discharge device, otherwise damage to the vehicle may occur.
- Before using the discharge device, read the Charging/Discharge Precautions section carefully.

Charge&V2L Status Indicator

Charging&V2L Status

When the vehicle is in P and a charging gun or external power supply device is plugged in, the touchscreen will automatically show the charge/discharge SR screen. You can view the vehicle's charging/discharging status on the SR screen of the touchscreen.

Preparing for Charging: After the charging gun is connected, the vehicle finishes preparing

to charge and waits for a response from the charging station.

Charging and Heating: In low-temperature environments, the system will automatically heat the traction battery to an appropriate temperature before starting to charge.

Charging: The vehicle is charging the traction battery via external charging equipment.

Charging Complete: Charging is complete; you may unplug the charging gun.

Charging Fault: A charging fault has occurred on the vehicle. Do not attempt to charge again. Contact an XPENG service center immediately.

Scheduled Charging: A scheduled charging time has been set. Charging will start automatically at the preset time.

Smart Scheduled Charging: Based on the set departure time, off-peak electricity rate period, and the vehicle's current state of charge, the system automatically plans the most appropriate charging strategy.



Power Supply in Progress : The vehicle is discharging power to external equipment through a discharge device.

Power Supply Done: Discharging is complete; you may disconnect the external discharge device.

Power Supply Failure: A discharge fault has occurred on the vehicle. Do not attempt to charge again. Contact an XPENG service center immediately.

Charging&V2L Precautions

Charging Precautions

To avoid personal injury or vehicle damage, be sure to observe the following precautions before performing vehicle charging operations:

- Before charging, check the charging cable. Do not use any charging cable with damaged insulation or housing.
- Before charging, make sure there is no water or foreign matter inside the vehicle charging

port, the power supply equipment, or the charging connector port, and that the metal terminals are free of rust or corrosion.

- Charge the vehicle in a relatively safe environment, avoiding rain and flooding, and keep away from open flames.
- Do not disassemble the charging gun, charging socket, or charging equipment; otherwise, charging failure or even fire may occur.
- Select a dry, well-ventilated location for charging. Do not use the charging equipment in areas where gasoline, paint, or other flammable or explosive materials are used or stored.
- Never use the charging cable in damp, humid, or shaded wet areas.
- Never allow children to perform charging operations.
- Do not touch the charging port.
- In rainy weather, do not charge the vehicle if there is no shelter from the rain.



- If there is a sudden change in weather during charging (strong wind, rain, snow, or thunderstorms), promptly check that the charging connector is securely connected and dry. During lightning and thunder, do not touch the charging cable or the vehicle body.
- If the area around the charging port becomes damp during charging, first switch off the power supply safely, then disconnect the power-side plug (do not touch the metal parts of the plug with your hands or any other part of your body to avoid safety incidents), and then unplug the charging gun. Use insulated gloves if necessary, and contact an XPENG service center as soon as possible for confirmation.
- If you notice an unusual odor from the vehicle while charging, stop charging immediately.
- Do not squeeze or compress the charging cable while charging.
- After charging is complete, do not disconnect the charging gun with wet hands or while standing in pooled water.
- Before driving the vehicle, make sure the charging gun has been disconnected from the vehicle charging port.
- When removing the charging gun from the charging station, hold the charging gun firmly with both hands to prevent the twisted charging cable from springing back and striking or injuring people.
- During charging, the charging cable must be laid out straight and must not be twisted.
- If any part of the charging equipment is corroded or damaged, such as deformed or bent metal terminals on the charging gun or a deformed or cracked plastic plug body, do not charge the vehicle.
- If an emergency occurs during charging, press the emergency stop button on the charging equipment to stop charging.
- When inserting or removing the charging gun, unlock the vehicle and insert or remove the gun vertically. Do not insert it at an angle or rock it.



- After charging, close the charging port cover promptly to prevent rain, snow, or foreign matter from entering.
- Vehicle charging and discharging may affect medical or implanted electronic devices. Before charging, consult the manufacturer of the electronic device.
- Because different charging-station manufacturers may interpret national charging standards differently and maintenance levels may vary, some charging stations may not be able to charge the vehicle successfully. If this occurs, try reconnecting the charging gun or using a different charging station.
- It is strictly prohibited to perform operations while the system is energized. Perform appropriate safety checks before operation.
- It is strictly prohibited to operate the equipment with wet hands.
- It is strictly prohibited to use the external discharge function when external electrical appliances or discharge equipment are damaged.
- It is strictly prohibited to allow minors to touch or use the discharge equipment. Keep minors away while it is in use.
- It is strictly prohibited to touch the pins of the appliance plug or the discharge equipment socket.

V2L precautions

To avoid personal injury or vehicle damage, be sure to observe the following precautions before performing vehicle discharge operations:

- It is strictly prohibited to modify the V2L discharge gun for use as a household power supply station, to avoid damaging the vehicle.

Charging Port Foreign Object Cleaning

Under normal use, clean the charging port weekly using compressed air and a soft brush. If this is not available, you may use a lint-free cloth



or cotton swabs to clean the charging port and the charging gun.

warning

- Never touch the charger barrel and socket with sharp objects such as screwdrivers or tweezers to avoid damaging the socket and socket.
- When a foreign object enters deep into the charging base, it must be cleaned by a professional.

Range Display Information

Range Display Standard Setting

The vehicle provides two range display standards: WLTP and CLTC. With the same remaining state of charge, the indicated remaining range will differ slightly depending on the selected display standard.

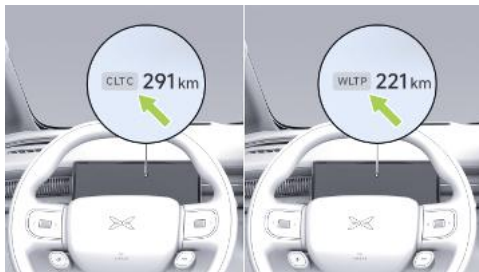

On the touchscreen, in the “ →Settings→Charging & Discharging→Charging” screen, select the range display standard.

Range Display Calibration

For vehicles equipped with an LFP (lithium iron phosphate) battery, the battery status must be calibrated by fully charging. When the status bar on the touchscreen shows “**Battery Status Needs Calibration**”, please fully charge the battery to 100% as soon as possible to perform calibration. To maintain the accuracy of the pure



electric range display, it is recommended to perform a full charge for calibration at least once every two weeks.

i Tips

To ensure charging safety, some brands of DC charging stations will automatically stop charging when the battery reaches approximately 95%. For battery calibration, it is recommended to use an official direct-sale charging station or an AC charging station.



User Accounts

Account Types

The vehicle supports multiple account types for log-into. Data is isolated between accounts, allowing you to enjoy a private, personalized cockpit.

- Owner account: The account that is first bound to and activates the vehicle during delivery.
- Authorized Account: Used to share the right to use the vehicle with another person. The account used by the person you share the vehicle with is called an authorized account.
- Guest Mode: Only certain functions such as air conditioner and navigation can be used.

After logging into an account, tap “

Log-into Account

When creating a Bluetooth key in the mobile App, you can enable the **Unlock and Log-into the Touchscreen with this Account** function. After it is enabled, unlocking the vehicle will automatically log into the account.

You can also tap the avatar on the touchscreen and then scan the code with a phone that is signed in to your XPeng App account to log into.

Authorized Accounts

Add Authorized Account

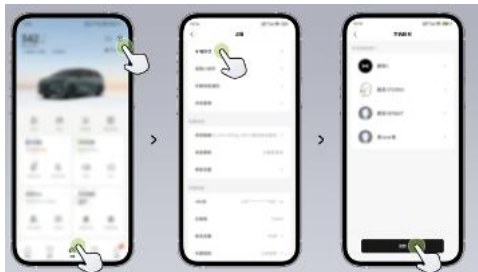



1. After the owner logs in to the XPENG App, tap “**XPENG→Settings→Vehicle Authorization→Add**” in sequence.

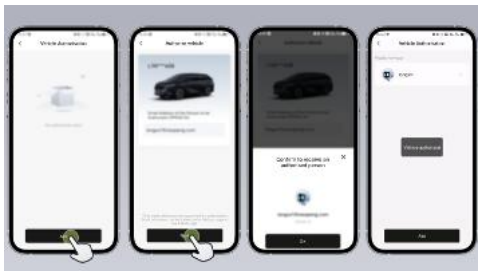

2. Select the authorization type “**Phone Key**”, enter the authorized person’s mobile phone number, and set the validity period as needed to share the right to use the vehicle with family or friends.

After the authorized user logs in to the XPENG App, they can create a Bluetooth key or use remote vehicle control functions. Up to 5 family

members or friends can be authorized to use the vehicle.

Permission Management for Authorized Accounts

1. After the owner logs in to the XPENG App, tap “**XPENG→Settings→Vehicle Authorization**” in sequence.
2. Find the user for whom you need to configure “**Authorization Management**”.
3. You can enable or disable the “**Charging Settings**” permission.
4. After the Charging Settings permission is enabled, the authorized user can configure the “**Charging Limit**”, “**Slow Charging Appointment Settings**”, and “**Press to Open Port for Supercharging Button**” functions in Charging Management.

Revoke Account Authorization

The owner can use the XPENG App to enter the “**Vehicle Authorization**” screen to view or manage authorized users.



You can revoke a user's authorization in the following ways:

1. Find the user whose authorization you want to revoke.
2. Click **“Revoke Authorization”**, then read and agree to the **“Authorization Revocation Notice”**, and click **“Confirm Revocation”**.



3. To ensure the safety of passengers and the vehicle, click **“Confirm Lock”**. After confirming that both the phone and vehicle status are normal, you can revoke this user's authorization.

i Tips

- To disarm or establish authorization, a good vehicle network signal is required, if the vehicle does not have a net or weak network, this may result in a failure of the operation.



- Once the authorization is released, the authorized person will not be able to lock or start the vehicle using the XPENG App. Check the vehicle status with the authorized person before operating (e.g. the vehicle is parked safely and there are no people or objects left in the vehicle) to avoid inconvenience to both parties.

Guest Mode

After switching to Guest Mode, personal sensitive information will be hidden, and functions such as driver assistance, browser, and app store downloads will be disabled. Only basic vehicle functions such as air conditioner and navigation can be used.

Manually Enable Guest Mode

When the gear selector is in P, you can activate Guest Mode as follows: in the pop-up window, read the prompt message and tap “**Enable**”. The touchscreen will then show the message “**Guest Mode Enabled**”.

- On the touchscreen, tap “**User Avatar**→**Guest Mode**” in sequence to enter the pop-up screen.
- On the touchscreen, tap “

Enable/Disable Automatic Guest Mode

After logging into with the owner account on the touchscreen and placing the gear selector in P, you can enable or disable automatic Guest Mode as follows:

- On the touchscreen, go to “**User Avatar**→**Settings**→**Account Settings**” to enable or disable automatic Guest Mode.
- On the touchscreen, tap “

caution

Guest mode can only be set in non-driving conditions.



Automatically Enter Guest Mode

After the automatic Guest Mode function is enabled, when you unlock the vehicle with the smart remote key, the touchscreen will show the message “**Guest Mode Enabled**” to remind you that the vehicle is currently in Guest Mode.

Exit Guest Mode

You can exit Guest Mode by using the XPENG App to scan the QR code and log into to your account as follows:



- On the touchscreen, tap “**User Avatar**”, then tap “**Log Into**” to enter the code-scanning screen.
- On the touchscreen, tap “”, then in the App Center tap “**Profile Center**→**Log Into**” to enter the code-scanning screen.
- After successfully pairing the vehicle’s Bluetooth with your phone’s Bluetooth key or wallet key, unlocking the vehicle will automatically log into to the associated user account and automatically exit Guest Mode.

Driving Habits

After logging into your account, when you adjust the seat position, exterior mirror position, and head-up display position, you can save these settings to Driving Preferences. The next time you log into, you can quickly switch to the saved positions. Each account can store up to 6 driving preferences.

Switch Driver’S Driving Preferences

You can use any of the following methods to quickly select the driving preference to be used this time. You can also add, delete, or rename saved driver’s driving preferences in the account settings screen.

- Tap “**User Avatar**” on the touchscreen to enter the driving preferences switch screen.
- On the touchscreen, tap “”, then in the App Center tap “**Profile Center**” to enter the profile center screen.
- After logging into your account, on the touchscreen tap in sequence “ → 



→**Seat Position**→**Select “Driver’s Seat”**→**Driving preferences**” to enter the Driving Preferences interface.

Voice Assistant

Enabling XPENG Voice Service

Turn the in-vehicle microphone on/off via the touchscreen

On the touchscreen “ →**Settings**→**General**→**Safety & Privacy**” screen, you can turn the “**In-vehicle Microphone**” on or off. When turning off the in-vehicle microphone, a pop-up window will appear for confirmation. After the in-vehicle microphone is turned off, Bluetooth phone, voice, and other related functions will not be available.

Tips

After the in-vehicle microphone is turned off, a “**Microphone Disabled**” icon will be displayed in the top bar of the touchscreen. Tap the icon,

and you can turn on the in-vehicle microphone in the pop-up window.

Turn XPENG intelligent voice service on/off via the touchscreen

On the touchscreen “ →**Settings**→**Intelligent Voice**” screen, you can turn the XPENG intelligent voice service on or off. After this function is enabled, you can control certain vehicle functions via voice.

Multi-Modal Conversation (Ultra models)

On the touchscreen “ →**Settings**→**Intelligent Voice**” screen, you can turn the multi-modal conversation function on or off. Before enabling this function, you must read and agree to the function description. After it is enabled, in-vehicle visual recognition, screen understanding, and voice information will be combined so that you can experience in-vehicle multi-modal large-model conversation.



i Tips

When you start the vehicle for the first time and complete the initial setup guide, it is recommended that you enable the multi-modal conversation function. After this function is enabled, the Intelligent Welcome function will be activated at the same time. After the Intelligent Welcome function is activated, XPENG will combine vehicle environmental information with user habits and use a multi-modal large model to predict Combo needs and provide proactive services. To enable or disable the Intelligent Welcome function, tap “Settings → General → Notification Settings” in sequence.

Waking&closing voice via steering wheel shortcut

Set Steering Wheel Shortcut Key

Press and hold the left scroll wheel on the steering wheel, and after setting the steering wheel shortcut key function to “**Wake up/Turn**

off Voice”, you can use the steering wheel shortcut key to wake up/turn off voice.

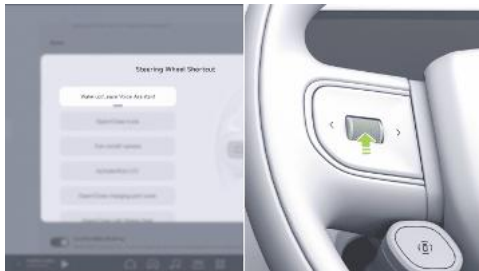

Use the Steering Wheel Shortcut Key to Wake up/Turn off Voice

Before using the steering wheel shortcut key to wake up/turn off voice, make sure that:

- The “**Intelligent Voice**” function is enabled and the vehicle’s voice function components are functioning properly.
- The “**In-vehicle Microphone**” function is enabled.



Briefly press the left scroll wheel on the steering wheel to wake up XPENG intelligent voice; after waking up XPENG, briefly press the left scroll wheel on the steering wheel again to turn off voice.

Waking PENG Voice Service

Press the voice button on the left side of the steering wheel to wake up the voice service. Press the voice button again to turn off the voice service.

On the touchscreen **Smart Voice** screen, set the voice wake-up method:

- “XPENG+” intelligent wake-up: You can directly use the voice service via “**XPENG+ frequently used vehicle control commands**”. For example: “XPENG, turn on the air conditioner.”
- Command Wake-up: You can directly speak explicit voice commands for vehicle control/music/phone, etc. For example: “Turn on the air conditioner.”

- Standard Wake-up: You can wake up the voice service by saying “**Hey XPENG**”, and then speak voice commands after wake-up. For example: “Hey XPENG, turn on the air conditioner.”

On the touchscreen **Smart Voice** screen, after tapping “**More Wake-Up Methods**”, you can set the following voice functions:

- Intelligent Wake-up for the Entire Vehicle: After it is turned off, only the driver can use “**XPENG+ Intelligent Wake-up**” and “**Command Wake-up**”.

Setting up PENG Voice Service

On the touchscreen “ → **Settings** → **Intelligent voice**” screen, you can configure the vehicle’s intelligent voice functions.

1. Conversation Mode: You can choose between two conversation modes: **Single-turn conversation** and **Continuous conversation**.
 - Single-Turn Conversation: After this is selected, XPENG can execute only one



command in each conversation and will exit the voice service immediately after execution.

- **Continuous Conversation:** After this is selected, once XPENG has completed the previous task, it can remain in a listening state for a period of time, during which you can issue new commands directly without waking up XPENG again.
2. **Speech Voice:** You can choose between two speech voices: **Female** and **Male**.
 3. **Broadcast direction:** You can choose between two voice broadcast directions: **Unidirectional** or **By Position**.
 4. **Activate Zones:** You can turn off the voice zone for a specific direction as needed. After it is turned off, the system will no longer receive voice commands from that zone.

XPENG, remember for me

After using the facial recognition function to register your facial data and link it to your login account, log in to your account on the

touchscreen and say to PENG, "Remember..." to record various ideas and frequently used information for you.

On the touchscreen, go to "  → **Settings** → **Intelligent Voice** → **Memory List** to manage the "XPENG, remember for me" list.

XPENG Recommendations

On the touchscreen, go to "  → **Settings** → **Intelligent Voice** to enable or disable the XPENG Recommendations function. After it is enabled, the system proactively predicts your needs based on your habits and environment and provides concierge-style personalized services.

- **Smart Temperature Control:** Can be set to "Off," "Low frequency," or "Default."
- **Comfort Pre-Conditioning:** Can be set to "Off," "Low frequency," or "Default."
- **Music Recommendations:** Can be set to "Off," "Low frequency," or "Default."
- **Say Hello:** Can be set to "Off" or "On."



XPENG Assistant User Experience Improvement Program

To help XPENG become smarter and more intelligent, we sincerely invite you to join the “XPENG Assistant User Experience Improvement Program”.

On the touchscreen, go to “ → **Settings** → **General** → **Security & Privacy**” to enable or disable “XPENG Assistant User Experience Improvement Program”.

Before enabling this function, you need to read and agree to the “XPENG Assistant User Experience Improvement Program.” After the function is enabled, the system may collect information about your voice usage to improve your voice interaction experience.

Music Apps

Switching Music Apps

XPENG provides customized music applications. Supported audio sources include online media such as QQ Music, NetEase Cloud Music, and KuGou Music, as well as local media such as Bluetooth Music and USB Music.

Tap “” on the bottom taskbar of the touchscreen. In the upper-left audio source entry of the music interface, you can switch audio sources and start playback.

Controlling media playback with steering wheel buttons

When multimedia is playing, you can use the buttons on the right side of the steering wheel for control:

- Press the left or right button to skip to the previous or next track.



- Press the scroll wheel to pause media playback.

Bluetooth Music

Switch the audio source to “**Bluetooth Music**”, then tap “**Connect Bluetooth**” to connect to your phone via Bluetooth, and you can listen to songs from your phone in the vehicle.

USB Music



1. Insert a USB drive containing music files into the front port of the center armrest box. When

the  icon appears in the status bar of the touchscreen, it indicates that the USB drive is successfully connected.

Tips

-  Read the contents of the USB drive.
- Frequency formats include: MP3, FLAC, WAV, OGG, AAC, MP4, MKV, M4A.
- The supported USB formats include: FAT32, FAT16, NTFS.

2. On the touchscreen, go to “ → **Music**”, then switch the audio source to “**USB Music**” to play the music stored on the USB drive.

Safely eject USB drive

To remove the USB drive, first go to the touchscreen “ → **Device Connection** → **Devices** → **USB Devices**” interface and tap “**Safely Eject**”, then remove the USB drive.



Sound Settings

Welcome Sound Effects

When the welcome sound effect function is enabled, after the driver enters the vehicle and closes the door, the system will play the welcome sound effect according to the settings.

On the touchscreen “ → **Settings** → **Vehicle** → **Lock/Unlock & Welcome**” screen, you can turn the “**Welcome Sound Effect**” function on or off, and configure the welcome sound effect.

Tips

- After unlocking the vehicle, if the user is seated in the driver's seat and repeatedly opens and closes the door, the Welcome Sound Effect will not be played.
- If the Welcome Sound Effect is changed, the new setting will take effect after the vehicle is powered on again.



Connect device

Bluetooth Connection

After your phone has been paired and successfully connected to the vehicle via Bluetooth, you can confirm on your phone to sync communication data (such as contacts and call history) from the mobile device to the vehicle, making it easier to receive and place calls and to better experience the hands-free calling function. You can also play music stored on your phone through the vehicle's audio system.

Turn Bluetooth on or off

You can turn Bluetooth on or off in the following way:

- On the touchscreen, go to “ → **Settings** → **Device Connection** → **Connection**” to turn Bluetooth on or off.
- On the touchscreen, tap in sequence “**Bluetooth**  icon in the top status bar of



the center display". In the pop-up menu, you can turn Bluetooth on or off.

- Wake up XPENG and say a voice command such as "Turn on Bluetooth" or "Turn off Bluetooth."

"Allow Detection"

After turning on the Bluetooth function, on the touchscreen go to "  → **Settings** → **Device Connection** → **Connection** → **Discoverable**". After you turn on the Discoverable function, other Bluetooth devices can detect the vehicle's Bluetooth.

If the system's Bluetooth device name cannot be found during Bluetooth pairing, restart Bluetooth on the mobile phone and search again.

Bluetooth pairing

You can pair your mobile phone with the vehicle via Bluetooth by following these steps:

1. Turn on Bluetooth on the mobile phone and set it to be discoverable.

2. Turn on Bluetooth on the touchscreen and set it to be discoverable.
3. On the Bluetooth screen of the touchscreen, the newly found available devices are shown. Select the name of the mobile device you want to pair from the list of available new devices to initiate a pairing request and establish a connection. Follow the on-screen instructions to complete pairing. Tap the "Search" icon to search again for new available Bluetooth devices.
4. After pairing is successful, you can view the name of the currently connected Bluetooth device on the Bluetooth screen.

On the Bluetooth screen of the touchscreen, select the paired Bluetooth device, tap Settings, and select Set as Preferred Device. This device will be given priority for connection when you enter the vehicle.

If Bluetooth cannot connect, delete the paired device from the Bluetooth settings on the mobile phone and then pair again.



Disconnect Bluetooth

After the mobile phone has been successfully paired and connected with the vehicle via Bluetooth, go to the Bluetooth screen on the touchscreen, select the paired Bluetooth device, tap Settings, and select Disconnect.

Delete Bluetooth pairing

- After the mobile phone has been successfully paired and connected with the vehicle via Bluetooth, go to the Bluetooth screen on the touchscreen, select the Bluetooth device to be unpaired, tap Settings, and select Unpair.
- When the mobile phone is not connected to the vehicle via Bluetooth, go to the Bluetooth screen on the touchscreen, select the Bluetooth device to be unpaired, tap Settings, and select Delete.

About Bluetooth

Because there are many mobile phone brands and differing functions, this system cannot guarantee compatibility with all phones.

If an abnormality occurs in the Bluetooth function during use, disconnect Bluetooth and reconnect.

Wi-Fi

Turn the Wi-Fi on or off

You can turn the Wi-Fi on or off in the following ways:

- On the touchscreen, go to “ → **Settings** → **Device Connection** → **Connection**” to turn the Wi-Fi on or off.
- On the touchscreen, tap “**Signal icon in the top status bar of the touchscreen** → **Wi-Fi**” to turn the Wi-Fi on or off. After it is turned on, tap “**Search Networks**”. The system will automatically scan for Wi-Fi networks.
- Wake up XPENG and say voice commands such as “Turn on Wi-Fi” or “Turn off Wi-Fi.”

Connect to a Wi-Fi network

When connecting for the first time, after turning on the Wi-Fi function, the system will



automatically scan for Wi-Fi networks. Select the name of the Wi-Fi network you want to connect to and enter the correct password to connect.

After the Wi-Fi network is connected successfully, the signal icon will change to the Wi-Fi icon. On the touchscreen, go to “ → **Settings** → **Device Connection** → **Connection**” to view the name of the connected Wi-Fi network.

For subsequent connections, when entering the coverage area of a Wi-Fi network, the system will attempt to automatically connect to saved Wi-Fi networks. After successful authentication, the status will show as connected. To switch to another Wi-Fi network, the system will automatically scan for Wi-Fi networks. Select the name of the network you want to switch to and enter the correct password to connect.

Tips

- You can connect to and use personal hotspots shared by your phone through wireless networking, and be aware of traffic consumption when using.

- The signal strength of the currently connected network can be viewed from the wireless network icon in the status bar, if the signal strength is low, the vehicle may be slow to access the internet.

On-board Hotspot

Turn the in-vehicle hotspot on or off

You can turn the in-vehicle hotspot on or off in the following ways:

- On the touchscreen “ → **Settings** → **Device Connection** → **Connection**”, you can turn the in-vehicle hotspot on or off.
- On the touchscreen, tap in sequence “**Signal icon in the top status bar of the touchscreen** → **In-vehicle Hotspot**”. In the pop-up window, you can turn the in-vehicle hotspot on or off.
- Wake up XPENG and say a voice command such as “Turn on the in-vehicle hotspot” or “Turn off the in-vehicle hotspot.”



Change the in-vehicle hotspot name and password

In the in-vehicle hotspot pop-up window, you can change the hotspot name and password. After changing the hotspot name or hotspot password (the wireless hotspot password must be at least 8 characters), the hotspot will restart automatically.

After changing the hotspot name or password, connected devices will be disconnected. To use the hotspot again, select the hotspot name and enter the correct hotspot password.

Connect to in-vehicle hotspot

When connecting for the first time, after turning on the in-vehicle hotspot, use another mobile device to search for the vehicle's in-vehicle hotspot name. Enter the correct password to connect.

After another mobile device successfully connects to the in-vehicle hotspot, the signal icon switches to the hotspot connection icon.

On the touchscreen “ → **Settings** → **Device Connection** → **Connection**”, you can view the number of connected devices.

When it is not the first connection and the in-vehicle hotspot is already turned on, other mobile devices that enter the wireless network coverage area of the hotspot will attempt to automatically connect to the saved wireless network. After successful authentication, the status will show as connected.

The in-vehicle hotspot uses the vehicle's data plan. On the touchscreen, tap in sequence “**Signal icon in the top status bar of the center display** → **Cellular Network**” to view data usage in the pop-up window. Be mindful of data usage when using this function.

Switch in-vehicle hotspot mode

On the touchscreen, go to “ → **Settings** → **Device Connection** → **Connection**”. After turning on the vehicle hotspot, you can select the hotspot mode: 5 GHz or 2.4 GHz.



i Tips

It is recommended to prioritize the 5GHz band. Enabling the 2.4GHz band can accommodate more devices, but network performance will decrease.



Seat Belts

Properly Wearing Seat Belts

Correct driving posture

Whether the driver's seating posture is correct directly affects driver fatigue and driving safety.

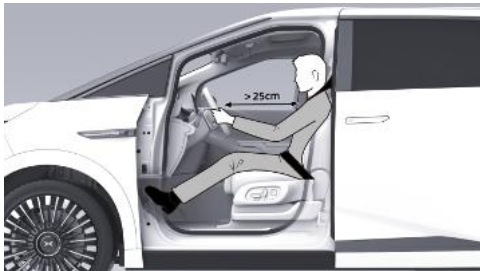

Adjust your driving posture correctly from the following aspects:

1. Sit upright with both feet placed on the floor.

2. Make sure both feet can easily reach the pedals, your arms are slightly bent when holding the steering wheel, and your chest is at least 25 cm away from the center of the steering wheel.

warning

- Do not adjust the driver's seat while driving to avoid loss of control due to sudden body inclination.
- When driving the vehicle, you must not wear slippers, high heels, barefoot or telephone to make conversations that interfere with safe driving.

Wearing the seat belt

Wearing the seat belt correctly can greatly reduce injuries to occupants in the event of an accident and improve driving safety.



1. Adjust the seat to a suitable position.
2. Pull the seat belt out slowly, position the shoulder portion between the neck and shoulder, and route the lap portion across the hips (not the abdomen).
3. Insert the seat belt tongue into the buckle until you hear a “click.”
4. Pull on the seat belt to check that it is securely latched in the buckle.

warning

- Do not place other objects between the seat belt and the body.
- Keep the seat belt buckle clean and remove any foreign objects from the buckle, otherwise the seat belt may not lock properly and may compromise your driving safety.
- When wearing a seat belt, the seat belt must be snug and untwisted, the shoulder belt must be bypassed from the middle of the occupant's shoulder, and must be snug against the occupant's upper body. The lap portion of the belt must be as far down as possible, around the hip, and if necessary, pull down slightly on the belt body. and pull in the direction of the seat belt retraction to adjust.

Unbuckling the seat belt

Only unbuckle the seat belt when it is safe to do so.

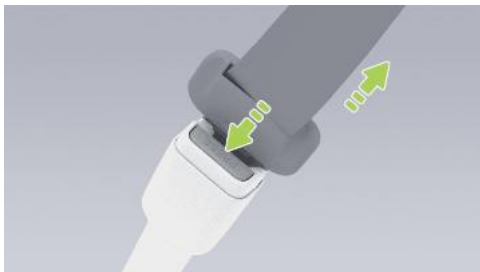

1. Hold the seat belt tongue and press the buckle release button.
2. After the buckle releases, allow the seat belt to retract automatically and place the tongue back in its original position.

⚠ warning

Do not release the seatbelt latch when the seatbelt is not fully retracted, as this may cause personal injury or vehicle damage due to excessively rapid retraction of the seatbelt.

Wearing Seat Belts During Pregnancy

Seat belts are also suitable for pregnant women. They should wear a seat belt throughout pregnancy, and the lap portion should lie as flat as possible across the front of the hips.

First, fully extend the shoulder belt, then route it across the middle of the shoulder and the center of the chest, and position the lap belt below the abdomen, across the hips, and fasten it correctly. When using the seat belt, avoid it contacting the protruding abdomen.





Safe Driving and Riding

Before driving, pregnant women should consult a doctor to determine whether they can drive.

warning

- When traveling in the vehicle, pregnant women should sit in the rear seats whenever possible to avoid secondary injury to the abdomen from airbag deployment in the event of a collision.
- Pregnant women driving the vehicle must be able to operate the pedals and steering wheel easily and maintain full control of the vehicle.

Seat Belt Unfastened Reminder

Front seat belt indicator lights

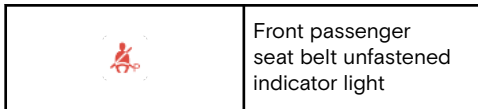
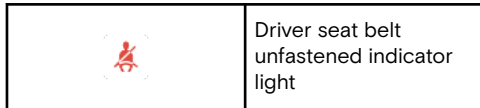



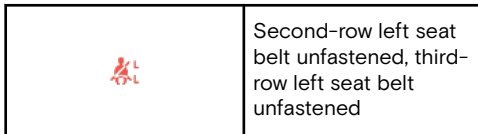

- If a front-seat occupant does not fasten the seat belt while the vehicle is stationary, the corresponding seat belt indicator on the instrument panel will illuminate.
- When the vehicle reaches a certain speed while driving, the corresponding seat belt indicator light on the instrument panel will flash, a warning window will pop up, and an audible warning will sound.





Rear seat belt indicator lights



Safe Driving and Riding



	<p>Second-row left seat belt unfastened, third-row left seat unoccupied or seat belt fastened</p>
	<p>Second-row left seat unoccupied or seat belt fastened, third-row left seat belt unfastened</p>
	<p>Second-row left seat unoccupied or seat belt fastened, third-row left seat unoccupied or seat belt fastened</p>
	<p>Second-row right seat belt unfastened, third-row right seat belt unfastened</p>

	<p>Second-row right seat belt unfastened, third-row right seat unoccupied or seat belt fastened</p>
	<p>Second-row right seat unoccupied or seat belt fastened, third-row right seat belt unfastened</p>
	<p>Second-row right seat unoccupied or seat belt fastened, third-row right seat unoccupied or seat belt fastened</p>
	<p>Third-row center seat belt unfastened</p>



Third-row center seat unoccupied or seat belt fastened

If any second-row or third-row passenger does not fasten the seat belt, the corresponding seat belt indicator light on the instrument panel will flash.

i Tips

If all occupants are wearing seatbelts and the indicator light is still on, please fasten your seatbelts again to ensure they are properly locked.

! warning

If the seatbelt reminder function malfunctions, please contact XPeng Motors service center immediately for inspection.

Inspecting Seat Belts

To ensure that the seat belts are functioning properly, check the seat belts before every drive by following the steps below:

1. Check the seat belt for any abnormal conditions such as wear or cuts.
2. Insert the seat belt tongue into the buckle, pull on the seat belt to check that the buckle is securely fastened, and make sure the seat belt is in proper working order.
3. Pull the seat belt sharply to check whether the retractor locks properly; unbuckle the seat belt and check that it retracts normally.

If any seat belt fails any of the above inspections, contact an XPENG service center immediately.

Pretensioner Seat Belts

The front and second-row seat belts are equipped with pretensioners. In a collision, the pretensioners automatically tighten the seat belt



webbing to reduce chest injury to occupants and mitigate personal injury.



If the pretensioners and airbags are not activated in a collision, this does not necessarily mean they are malfunctioning. This usually means that the severity or type of collision did not meet their activation criteria.

warning

- Do not bend, sit, or obstruct the seat belt pre-tensioning mechanism, as damage may

occur and interfere with the correct function of the seat belt system.

- Once activated, the seatbelt pretensioner must be replaced. After a collision, the airbags and other related components must be checked and replaced if necessary.
- To ensure that the seat belt pretensioner operates correctly in certain collision situations, even if it is not triggered, contact Xpeng Automobile Service Centre immediately to inspect the vehicle safety system components.

Seat Belt Precautions

Strictly follow the warning information below; failure to do so may result in serious injury, death, or damage to the vehicle.

warning

- All persons in the vehicle must wear seat belts correctly when driving, otherwise the risk of injury or death is increased in the event of an accident.



Safe Driving and Riding

- Do not press the seat belt on fragile or sharp objects (e.g. pens, keys, glasses, etc.), where the pressure on the seat belt may cause injury.
- Each seat belt is intended for use by only one person in the vehicle, and it is prohibited to hold a child on his or her lap and share the seat belt with the child.
- Avoid contaminating the seat belt with any chemicals, liquids, etc.
- Do not remove or install seat belts, belt retractors, and seat belt anchors without authorization. Retrofit, disassembly, etc.
- Do not add additional non-official attachments to the seat belt, including, but not limited to, additional tongue locks, webbing stops, latch extension joints, etc. The normal protection of the seat belt can be reduced or even lost.
- When not in use, the seat belt should be fully retracted and not overhang. If the seat belt cannot be retracted or locked in the latch and cannot be removed, you

must contact the Xpeng Automobile Service Centre immediately for service.

Airbags

Airbag Overview

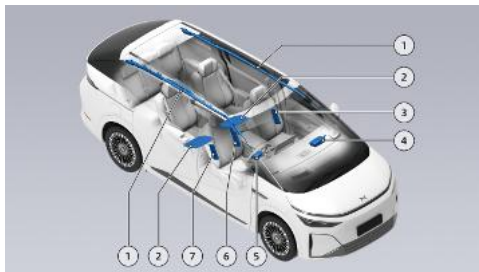

Airbags are passive safety protection devices that work together with the seat belts to provide additional protection for the driver and passengers.



1. Front and rear head curtain airbags	5. Driver airbag
2. Second-row seat cushion airbags	6. Driver far-side airbag
3. Front passenger seat side airbag	7. Driver seat side airbag
4. Front passenger airbag	

Driver and front passenger airbags

The driver airbag is installed in the center of the steering wheel. The word “**AIRBAG**” is printed in the middle of the steering wheel.

The front passenger airbag is installed on the right side of the instrument panel. The word “**AIRBAG**” is printed at the right end of the instrument panel.

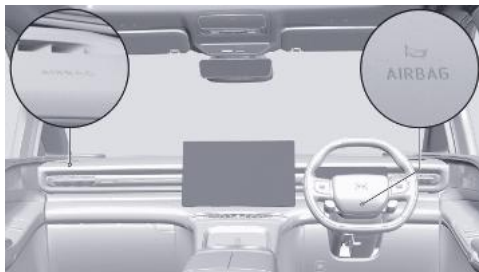

When the vehicle is subjected to a severe impact, the driver and front passenger airbags protect the head and chest of the driver and front passenger.

Front side airbags

The side airbags are installed in the backrests of the front seats. The outer side of the driver seat backrest is marked with “**SRS AIRBAG**”, and the installation marking for the front passenger seat side airbag is arranged symmetrically to it.



When the vehicle is subjected to a severe impact, the front side airbags help protect the chest and hip areas on the side of the driver and front passenger.

Driver far-side airbag

The driver far-side airbag is installed in the driver seat backrest. The inner side of the driver seat backrest is marked with “SRS AIRBAG”.



When the vehicle is subjected to a severe impact, the far-side airbag protects the shoulders and head of the driver and front passenger to minimize injury as much as possible.

Second-row seat cushion airbags

The second-row seat cushion airbags are installed inside the seat cushions of the second-row seats.

When the vehicle is subjected to a severe impact, the seat cushion airbags protect

Safe Driving and Riding



the waist and abdomen of the second-row occupants.

Front and rear head curtain airbags

The front and rear head curtain airbags are installed along both sides of the roof. The interior trim of the B-pillars is marked with “AIRBAG”.



When the vehicle is subjected to a severe impact, the curtain airbags protect the heads of the driver and passengers.

Airbag Fault Indicator Light



After the vehicle is powered on, the indicator light on the instrument panel for “” will illuminate for several seconds and then turn off after the system completes self-check. If the indicator light does not turn off after the system self-check, or turns on again after going off, or remains continuously illuminated, this indicates a malfunction in the airbag system. Contact an XPENG Service Center immediately for inspection and repair.



Airbag Deployment Conditions

Whether the airbags deploy does not depend on the vehicle speed at the time of the accident, but on the collision severity detected by the collision sensors during the accident. If the impact force of the collision is absorbed or dispersed by the vehicle body, the airbags may not deploy; however, depending on the impact conditions during the accident, the airbags may sometimes deploy. Therefore, whether the airbags deploy is not determined by the extent of vehicle damage.

In the following situations, the airbags may deploy:

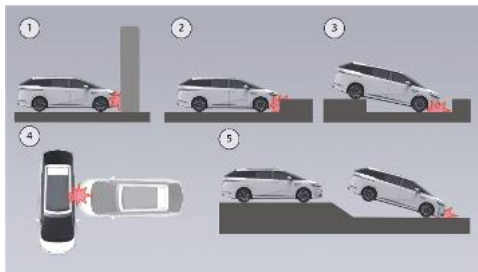

1. A high-speed frontal collision with a wall or another vehicle.
2. Impact with a hard roadbed.
3. Falling into a deep ditch.
4. A side impact from another vehicle traveling at a relatively high speed.
5. A severe impact when the vehicle becomes airborne and then lands.



Effects of airbag deployment

caution

- In the instant of airbag deployment, a loud noise is associated with the release of gas and powder, which may irritate the skin and eyes. At this point, under the premise of safety, should escape outside the vehicle as soon as possible, if not, The window or door should be opened to allow fresh air to be drawn in.
- When the powder gets into the eyes or adheres to the skin when the airbag is detonated, wash thoroughly with clean water as soon as possible and seek medical advice if you are seriously unwell.
- When deployed, the air bag retracts in volume, providing a gradual damping effect for the occupants, ensuring an unobstructed view of the driver's forward vision.

After a collision in which the airbags deploy, the vehicle will automatically take several safety measures to protect the occupants:

- All doors are unlocked.
- The hazard warning lights are turned on.
- The vehicle high-voltage system is shut down.
- Cut off the fuel supply system.
- All doors and windows will automatically lower.
- Automatically place an emergency rescue call.
- Trigger the Multi-Collision Brake (MCB) system to prevent secondary collisions.

In the event of a serious accident, power supply or network abnormalities in the vehicle may occur, and the above actions may not be carried out. Use the interior emergency release handle to open the door and exit the vehicle.

Tips

In an emergency, breaking a window can be used to escape.



Conditions in which the airbag will not deploy

In the following situations, the airbags may not deploy. Always use the seat belts correctly to protect the occupants:

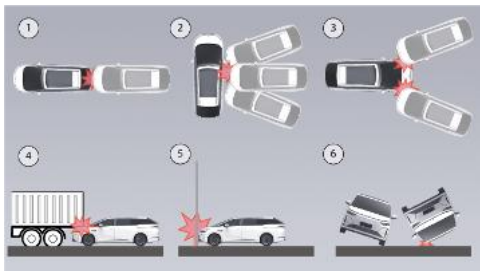

1. The airbags may not deploy when the vehicle is rear-ended.
2. In a side collision, due to the collision angle, the triggering conditions for the airbag sensors may not be met, and the airbags may not deploy.

3. In a front-corner collision, due to the collision angle, the triggering conditions for the airbag collision sensors may not be met, and the airbags may not deploy.
4. If the vehicle collides with a container truck or underrides a large truck, the triggering conditions for the airbag collision sensors may not be met, and the airbags may not deploy.
5. If the vehicle collides with slender objects such as trees or poles, the triggering conditions for the airbag collision sensors may not be met, and the airbags may not deploy.
6. The airbags may not deploy if the vehicle rolls over sideways.

Child Safety

Child Seating Guidelines

To protect children when traveling in the vehicle, select and use an appropriate child safety seat according to the child's age, weight, and height,

Safe Driving and Riding



and strictly follow the instructions provided by the child safety seat manufacturer.

Do not install a child safety seat on the front passenger seat.

A front airbag warning label is affixed to the front passenger sun visor, and another front airbag warning label is affixed to the front passenger side ceiling. The label on the sun visor is visible when the visor is lowered.



Front Passenger Airbag Disabling

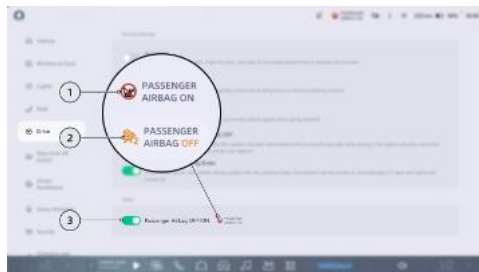

1. Front passenger airbag on
2. Front passenger airbag off
3. Front passenger airbag switch

The front passenger airbag is on by default and can be turned off/on in the following ways:

1. Passenger Airbag OFF/ON can be turned on/off at the “ → Drive” interface of central control panel.



warning

- Do not place a rear-facing child seat on the seat with an active frontal airbag. Death or serious injury to the child in the seat can occur.
- Be sure to select an appropriate child safety seat for the child based on his/her age, height and weight.
- One child seat is for only one child. Never constrain multiple children into one child seat with the seat belt.
- Under no circumstances should a child or infant be carried in the occupant's arms during driving.
- Never leave a child unattended in the child seat.
- Never leave children unprotected in a vehicle. Always keep children in the correct seating position during driving. Never stand in the vehicle or kneel on the seat. If an accident occurs under these circumstances, it could be fatal to children and others.

- Any child seat that has been applied forces in an accident must be replaced.

Transporting larger children

If a child is too large to use a child safety seat but still too small to safely use the standard seat belt alone, you may purchase and correctly use a child booster cushion that complies with applicable regulations or standards. A child booster cushion raises the child so that the shoulder belt passes across the middle of the shoulder and the lap belt is positioned low across the hips.

warning

- Rear-facing child seats must not be placed in seats protected by airbags, as this may result in the death or serious injury of the child inside.
- Always select a suitable child safety seat according to the child's age, height, and weight.



- Children weighing over 9 kg and capable of sitting independently should use forward-facing child safety seats. Children under two years old have underdeveloped spines and necks and should be protected from frontal collisions.
- Never hold a child or infant in your lap while the vehicle is in motion. All children should always be restrained in a suitable child safety seat.
- Even when a child is secured in a child safety seat, never leave them alone in the vehicle.
- Never allow children to ride in a vehicle without safety protection. Always ensure children maintain a proper sitting posture while the vehicle is in motion; never allow them to stand or kneel in the seat. Doing so may cause fatal injury to the child and others in the event of an accident.
- Do not use seat belt extenders on seat belts intended for use with child safety seats or booster seats.
- When a larger child is in the seat, ensure the child's head is supported and adjust and secure the child seat belt appropriately. The shoulder belt must avoid the face and neck, and the overlap must avoid the abdomen.
- One child seat is for one child only. Do not use seat belts to restrain multiple children in one child seat.
- Never fasten two child safety seats to a single anchor point. In the event of a collision, one anchor point may not be sufficient to secure both seats.
- The anchor point for a child safety device should only bear the load from a correctly installed child safety device. Child safety devices must never be used with adult seat belts, wiring harnesses, or to install other items or equipment.
- Always check for damage and wear on seat belts and straps.
- Never use a modified, damaged, or previously damaged child safety seat. Please



check or replace the child safety seat according to the manufacturer's instructions.

- To ensure your child's safety, always follow all the instructions detailed in this manual and the instructions provided by the child safety seat manufacturer.



Child Seat Categories

Child safety seat size categories

Size categories	Meaning
A	Full-height forward-facing child restraint system for toddlers who are learning to walk
B	Reduced-height forward-facing child restraint system for toddlers who are learning to walk
B1	Reduced-height forward-facing child restraint system for toddlers who are learning to walk
C	Full-size rear-facing child restraint system for toddlers who are learning to walk
D	Reduced-size rear-facing child restraint system for toddlers who are learning to walk
E	Rear-facing child restraint system for infants
F	Left side-facing child restraint system (carycot)
G	Right side-facing child restraint system (carycot)



Information on the suitability of child restraint systems for different seating positions

Mass group		Front passenger seat	Second-row left seat	Second-row right seat	Third-row left seat	Third-row center seat	Third-row right seat
Group O	10 kg	X	U	U	U	X	U
Group O+	13 kg	X	U	U	U	X	U
Group I	9-18 kg	X	U	U	U	X	U
Group II	15-25 kg	X	U	U	U	X	U
Group III	22-36 kg	X	U	U	U	X	U

Notes:

U: This mass group is suitable for “Universal” category child restraint systems.

X: This seating position is not suitable for child restraint systems of this mass group.

Safe Driving and Riding



Information on the compatibility of different ISOFIX positions with ISOFIX child restraint systems

Mass group		Size categories	Anchor ages	Front passenger seat	Second-row left seat	Second-row right seat	Third-row left seat	Third-row center seat	Third-row right seat
Portable infant cot		F	L1	X	X	X	X	X	X
		G	L2	X	X	X	X	X	X
Group O	10 kg	E	R1	X	IL	IL	IL	X	IL
Group O+	13 kg	E	R1	X	IL	IL	IL	X	IL
		D	R2	X	IL	IL	IL	X	IL
		C	R3	X	IL	IL	IL	X	IL



Group I	9-18 kg	D	R2	X	IL	IL	IL	X	IL
		C	R3	X	IL	IL	IL	X	IL
		B	F2	X	IUF	IUF	IUF	X	IUF
		B1	F2X	X	IUF	IUF	IUF	X	IUF
		A	F3	X	IUF	IUF	IUF	X	IUF

Notes:

IL: Suitable for ISOFIX child restraint systems of the “specific vehicle, restricted, or semi-universal” category.

IUF: Suitable for universal ISOFIX forward-facing child restraint systems for this mass group.

X: ISOFIX child restraint systems cannot be installed in this seating position.

ISOFIX: An international standard for attachment points for child safety seats in passenger vehicles.



Recommended Child Seat Types

This section provides a brief introduction to the recommended brands and models of child safety seats. For detailed installation procedures, refer to the installation and operating instructions supplied with the child safety seats.

Type I:

The recommended child safety seat is the “**Baby First Space Castle-Z (R102C)**” child safety seat. This child safety seat is suitable for children weighing up to 25 kg (reference age ≤ 7 years). When used by children weighing less than 9 kg (reference age 0–9 months), a rear-facing installation must be used. When used by children weighing up to 18 kg (reference age ≤ 4 years), a rear-facing installation is recommended.

Type II:

The recommended child safety seat is the “**Globalkids Gifted PLUS**” child safety seat. This child safety seat is suitable for children weighing up to 18 kg (reference age ≤ 4 years). When used

by children weighing less than 9 kg (reference age 0–9 months), a rear-facing installation must be used. When used by children weighing 9–18 kg (reference age 9 months–4 years), a rear-facing installation is recommended.

Type III:

The recommended child safety seat is the “**Baby First Rex Yaozhi (Smart Edition)**” child safety seat. This child safety seat can communicate with the in-vehicle touchscreen via Bluetooth. After the child safety seat is installed, pair it with the touchscreen to activate the ISOFIX anchorage status reminder function for the child safety seat. If the child safety seat ISOFIX is not successfully anchored, the touchscreen will provide a warning and an alarm.

Child Seat Installation Methods

This vehicle provides multiple attachment methods for child safety seats. Before installing a child safety seat, carefully read the child safety seat’s user manual and select the required



attachment method according to the instructions to secure the child safety seat.

i Tips

When installing any type of child seat, the second-row seat position must be adjusted.

- When installing it on a second-row seat, move the second-row seat to the rearmost position and activate the second-row child safety lock.
- When installing it on a third-row seat, move the second-row seat to the foremost position and activate the third-row child safety lock.
- When installing child seats on both the second-row and third-row seats at the same time, adjust the second-row seat to a suitable position and activate both the second-row child safety lock and the third-row child safety lock.

Securing a rearward-facing child safety seat with the seat belt

1. After adjusting the backrest angle of the second-row/third-row seat to a reclined position and , place the child safety seat on the vehicle seat.
2. Pull out the seat belt. Making sure the belt is not twisted, route the lap portion of the belt through the guide slots located under the armrests on both sides of the child safety seat. At the same time, route the shoulder portion of the belt through the seat's guide, around the back of the child safety seat, and insert the shoulder belt together with the lap belt into the buckle on the other side.
3. Shake the child safety seat to make sure it is securely installed.



Securing a forward-facing child safety seat with the seat belt

1. If the headrest interferes with installation of the child safety seat, raise it to the highest position.
2. After adjusting the backrest angle of the second-row/third-row seat and , place the child safety seat on the vehicle seat. The backrest of the child safety seat must fit as closely as possible against the seat backrest.
3. Then fully pull out the seat belt. With the seat belt not twisted, route and fasten the seat belt according to the child safety seat manufacturer's instructions.
4. Allow the seat belt to retract while firmly pushing the child safety seat into the vehicle seat, tightening any slack in the belt. If the child seat is equipped with a top tether strap, attach the tether to the seat backrest.
5. Shake the child safety seat to make sure it is securely installed.



Safe Driving and Riding



Installing a child seat using ISOFIX anchor points

The ISOFIX anchor points for the second-row seats are located between the seat backrest and the seat cushion, and each anchor point is marked with an ISOFIX symbol above it.



The ISOFIX anchor points for the outer seats in the third row are located between the seat backrests and the seat cushions, and each anchor point is marked with an ISOFIX symbol above it.



The upper anchor points for the second-row seats are located below the rear side of the seat backrests. Before using an upper anchor point, pry off its trim cover with an appropriate tool.



The upper anchor points for the outer seats in the third row are located on the rear side of the seat backrests.



Safe Driving and Riding



1. If the headrest interferes with installation of the child safety seat, raise it to the highest position.
2. After adjusting the backrest angle of the second-row/third-row seat and , place the child safety seat on a second-row seat or an outer third-row seat. The backrest of the child safety seat must fit as closely as possible against the seat backrest.
3. Insert the lower attachment brackets of the child safety seat into the ISOFIX anchor points in accordance with the child safety

seat manufacturer's instructions, and make sure the lower attachments are securely locked.

4.
 - Second-row seats: With the top tether strap of the child safety seat not twisted, pass it between the two headrest posts below the headrest, pull it to the rear of the seat backrest, attach the hook of the strap to the anchor point, and tighten the strap until there is no slack.



- Third-row seats: Route the top tether strap of the child safety seat through the



headrest, pull it to the rear of the seat backrest, attach the hook of the strap to the anchor point, and tighten the strap.



5. Shake the child safety seat to make sure it is securely installed.

Checking the child safety seat

After installing the child safety seat, always make sure that it is not loose:

1. Following the seat belt routing, secure the child safety seat and try to move the child

safety seat from side to side and from front to back.

2. If the child safety seat can move more than 2.5 cm, it is too loose. Tighten the seat belt or reconnect the ISOFIX-mounted child safety seat.
3. If it cannot be tightened sufficiently, try another seating position or use a different child safety seat.

warning

- The child safety seat must be fitted correctly and always in accordance with the manufacturer's installation instructions to avoid the child safety seat not being protective in the event of an accident.
- Do not secure more than one child seat in a single seat belt or single anchor position. The increased load on multiple seats can damage the seat belt or anchor, causing serious injury or death.



Disabling the seat belt unfastened warning after installing a child safety seat

After installing or removing a child safety seat, you can set the seat belt unfastened warning function for the child seat positions as follows:

On the touchscreen, go to “ → **Settings** → **Vehicle** → **Seats & Steering Wheel** → **Rear Seat Belt Reminder**”. Tap “**Child Safety Seat**” in the upper right corner, then select the seating positions for which you want to enable or disable the seat belt unfastened warning.

caution

- You may turn off the seat belt unfastened warning for a child seat position only after a child safety seat has been installed at that position.
- After the second-row/third-row seat belt unfastened warning is turned off, the system will not issue an audible warning if a second-row/third-row passenger is not wearing a

seat belt. After removing the child safety seat, immediately turn the second-row/third-row seat belt unfastened warning back on.

Electronic Child Lock

Child Lock

On the touchscreen, tap “” to enter the Control Center screen, where you can quickly enable the window child lock, door child lock, and rear control screen lock.

Tips

- It is recommended that the child safety lock is activated when the child is sitting in the rear row.
- To ensure safety when children are in the vehicle, lock the passenger glass up and down to prevent children from operating the windows to avoid pinching.



warning

When the child safety lock is activated, the corresponding door cannot be opened from the inside. Do not leave children unattended in the vehicle.

Rear Entertainment Screen Control Lock

When traveling with children, to prevent them from accidentally turning the rear entertainment screen on or off, you can activate the rear entertainment screen child lock function. Once activated, the rear entertainment screen can only be turned on or off via the center display.

On the touchscreen, in the “ → **Settings** → **Display**” screen, you can turn the rear control screen on or off.



Quality Guarantee Description

Limited Quality Guarantee

1. Scope of Quality Assurance

This Warranty/Maintenance Manual applies to XPENG vehicles purchased and used by users within the territory of the People's Republic of China (excluding the Hong Kong Special Administrative Region, the Macao Special Administrative Region, and the Taiwan region). Within the limited quality warranty period specified in this manual, if damage occurs due to product quality issues (i.e., defects in product design, manufacturing, or raw materials), XPENG will provide warranty service for such damage (excluding the items specified in the “**Exemption Clauses of the Three Guarantees**”), and will cover the cost of parts, labor for repairs, and other reasonable expenses confirmed by XPENG (meaning rescue and on-site service charges incurred by authorized personnel from XPENG Service Centers, and reasonable transportation cost compensation).

2. Quality Warranty Periods

The limited warranty periods for the vehicle specified in this manual are divided into different limited quality warranty periods, including the key component warranty period, wear-and-tear component warranty period, special component warranty period, and vehicle warranty period. The applicable period is determined by whichever comes first between time and range. For details, see the table below:

Genres	Item	Limited Quality Warranty Period
--------	------	---------------------------------



Key components	Traction battery and battery management system; drive motor and its controller	96 months or 160,000 km
Wear-and-tear components	Wiper blades	6 months or 5,000 km
	12 V battery, remote control battery, A/C filter element, brake friction pads, tires, fuses, and standard relays (excluding integrated control units)	12 months or 20,000 km
Special components	Audio system, rubber parts, glass, sensors, relays, and paint	36 months or 60,000 km
Whole vehicle	Original vehicle parts other than key components, wear-and-tear components, and special components	Non-commercial-use vehicle: 60 months or 120,000 km Commercial-use vehicle: 36 months or 60,000 km

3. Notes on Warranty Periods:

The warranty periods for key components, wear-and-tear components, special components, and the whole vehicle all commence on the delivery date. The applicable period is determined by whichever comes first between time and range. If any accessories or premium items have separately agreed



quality warranty periods, those agreed warranty periods shall prevail. If the registered usage type of the user's vehicle has been changed, the vehicle warranty period shall in all cases be implemented according to the commercial-use vehicle standard. If the vehicle's mileage has been tampered with without authorization, XPENG will fulfill its warranty obligations based on the vehicle's actual mileage.

For household vehicle products, the validity period of the Three Guarantees is 24 months or 50,000 km of driving (starting from the delivery date, with whichever comes first between time and range applying). Household vehicle products refer to passenger vehicles and pickup trucks that consumers purchase and use to meet their daily living consumption needs. Within the validity period of the Three Guarantees, if a failure of a household vehicle product meets the conditions for replacement or return specified in national or local mandatory regulations, the user may apply to XPENG for a replacement or return by presenting the Three Guarantees Certificate, the vehicle purchase invoice, and other valid proof.

4. Transfer of Ownership

The limited vehicle quality warranty specified in this Manual will not change due to transfer of vehicle ownership, but the remaining limited warranty period for the vehicle shall still be calculated from the delivery date to the first owner of the vehicle.

Limited Quality Guarantee for Replacement Parts

Genuine parts that XPENG recommends users to purchase and use in order to maintain vehicle safety and performance, and that are replaced at an XPENG service center (hereinafter referred to as "**Service Center**") (i.e., parts supplied or approved by XPENG), are covered by a limited parts quality warranty. Within the limited parts quality warranty period ("**Limited Parts Quality Warranty Period**"), if, under normal use of the vehicle, a part exhibits quality issues caused by design, manufacturing, or raw



material defects, XPENG will provide warranty service for the aforementioned part. The limited quality warranty period for replaced parts varies depending on the replacement circumstances of the parts, and specifically includes the following:

1. Genuine parts replaced for non-quality reasons

Genuine parts that are replaced at a Service Center for reasons other than quality issues caused by design, manufacturing, or raw material defects are covered by a limited parts quality warranty of 12 months or 20,000 km from the date of settlement of the Service Center repair order, whichever comes first. The limited quality warranty period for wiper blades is 6 months or 5,000 km from the date of settlement of the repair order, and the limited warranty period for range extender engine oil filters is 12 months or 10,000 km from the date of settlement of the repair order, whichever comes first.

2. Genuine parts replaced due to quality reasons

For genuine parts that are replaced free of charge at an XPENG Service Center due to quality issues caused by design, manufacturing, or raw material defects, the limited parts quality warranty period is the same as the remaining limited warranty period of the replaced part, and ends simultaneously with the expiration of the remaining limited quality warranty period of the replaced part.

Dispute Resolution

If you have any questions regarding the three-guarantee obligations for the XPENG household vehicle product you purchased, please contact an XPENG service center or sales and service store, or contact XPENG official customer service (phone: 400-783-6688) / the XPENG App - Service - “Peng Manager” dedicated service group for assistance. XPENG sales and service stores will negotiate with



you for a solution in accordance with Article 34 of the “Provisions on Responsibilities for Repair, Replacement and Return of Household Vehicle Products.”

Quality Guarantee-Related Notes

1. Warranty Certificate

1. If the Three Guarantees Certificate is lost, the user should promptly apply to XPENG for a replacement. After reissuance, the user may continue to enjoy the related warranty services.
2. The vehicle purchase invoice, Three Guarantees Certificate, and repair work orders are important proof documents for the user to obtain warranty services. XPENG reminds users to keep them properly to avoid loss or damage.

2. Maintenance and Service Records

If certain repair or maintenance items have been performed on the user's vehicle, the user should keep the relevant valid documentation, as it is an important basis for proving that the user has correctly carried out the related repair or maintenance in accordance with the User Manual.

3. Repair Time

When the user's vehicle is being repaired at an XPENG Service Center, please allow the Service Center a reasonable amount of time to complete the work. The Service Center will complete the repair as soon as possible and return the repaired vehicle to the user.



4. Repair Plan

Subject to applicable laws and regulations, XPENG and its Service Centers are entitled to determine the specific repair plan or parts replacement plan based on technical requirements and the actual condition of the user's vehicle. Any parts replaced in the course of warranty service become the property of XPENG.

5. Product Changes

XPENG reserves the right to make design changes to the vehicle and is under no obligation to implement any identical or similar changes on vehicles that have already been sold.

6. Recall Activities

In the event of a product recall, XPENG will provide a reasonable repair plan based on the nature of the product defect. In general, problems can be resolved by repairing or replacing parts. To eliminate vehicle defects as quickly as possible and ensure driving safety, after receiving a recall notice from XPENG or learning about related recall information through official channels, the user should actively cooperate with XPENG and its Service Centers so that they can provide recall-related repair services.

7. Other Matters

This vehicle is an intelligent electric vehicle that incorporates many advanced technologies. Therefore, before using the vehicle, the user should carefully read the User Manual and use and maintain the vehicle in accordance with the requirements in that manual. Before having emergency repairs carried out on the vehicle at a non-XPENG Service Center, the user should contact XPENG in advance.



If the user has any questions about the rights or obligations related to quality warranty described in this manual, they may contact XPENG directly.

Maintenance Guide

I. Necessity of Maintenance

1. To ensure normal use of the vehicle and a good driving and riding experience, to maintain vehicle efficiency and reliability, and to reduce potential repair costs, it is essential to carry out daily maintenance and regular servicing of the vehicle.
2. For daily maintenance items that are clearly specified in the User Manual as tasks that can be performed by the user, the user may carry out such daily maintenance in accordance with the relevant instructions in the User Manual.
3. In view of the complexity of the vehicle systems and the strict after-sales service requirements for new energy vehicles imposed by national laws and regulations, XPENG strongly recommends that users have regular maintenance performed at an XPENG Service Center.
4. If the user has any questions about how to maintain the vehicle, they may contact XPENG directly.

II. Routine Maintenance and Precautions

Daily maintenance is very important for ensuring driving safety and reducing vehicle failures. Before driving, the user should check the following items, and if any abnormality is found, please contact XPENG promptly.



- a. Driving range is related to the depth of discharge. To prevent excessive discharge from affecting the performance of the traction battery, it is recommended that you charge the vehicle promptly when the low battery warning light appears on the instrument panel.
- b. The actual driving range of the vehicle will decrease as the vehicle ages.
- c. Use of the air conditioner system will reduce the overall driving range.
- d. Under extreme temperatures and low battery conditions, due to the characteristics of the traction battery, weak acceleration and insufficient power may occur.
- e. Have the vehicle serviced regularly.
- f. Maintain correct tire pressure.
- g. Avoid using the vehicle as much as possible in extremely hot or severely cold weather.
- h. After using the vehicle in winter, do not leave it parked for an extended period; charge it as soon as possible.
- i. Remove unnecessary items to reduce the vehicle load.
- j. When necessary, turn off high-power electrical equipment such as the air conditioner, or adjust the heating or cooling temperature to reduce the energy consumption of high-power electrical devices and increase driving range.
- k. At high speeds, close the windows to reduce aerodynamic drag and decrease power consumption.
- l. Maintain a steady speed and avoid rapid acceleration and sudden braking.
- m. When accelerating, press the accelerator pedal gently as much as possible.



III. Regular Maintenance

1. Vehicle maintenance includes the first scheduled service and basic whole-vehicle maintenance. Regular maintenance is very important to keep the vehicle in good condition, reduce operating costs, and extend the service life of the vehicle. It is strongly recommended that you follow the User Manual requirements and regularly visit an XPENG Service Center for a comprehensive inspection and maintenance of the vehicle.
2. You can check the next maintenance time in the XPENG App under “XPENG - Maintenance Reminder”:
3. When your vehicle is due for maintenance, the maintenance reminder function will send a notification via the vehicle's CID/XPENG App , informing you of the remaining mileage/time until the next maintenance appointment.

i Tips

The maintenance reminder function will only pop up when you start the vehicle, not while driving, and will not affect your driving safety.

After in-store maintenance, we can reset the functions and remove the reminder marker display.



Opening&Closing Front Hood

Operation

Opening the front hood

1. Pull the front hood release handle located at the lower left of the instrument panel twice in succession. The front hood will pop up slightly and unlock.



2. Raise the front hood to the stop position, remove the support rod from its retaining clip, and insert it into the opening provided on the underside of the hood.



warning

Make sure the support rod firmly supports the front hood to prevent it from falling onto your head or body.

Closing the front hood

1. Slightly lift the front hood, place the support rod back into its retaining clip, then lower the front hood to about 30 cm above the fully closed position and release it, allowing it to fall freely.



2. After closing, check that the front hood is fully latched. The instrument, touchscreen, and HUD will all indicate the open/closed status of the front hood.

warning

- When closing the front hood, be especially careful to avoid trapping your fingers or other body parts.
- If the front hood is not properly latched, it may open while the vehicle is in motion, which could cause an accident resulting in serious injury or death.

Fluid Inspection

Fluid Fill Port Overview



1. Wiper washer fluid filling port
2. Coolant filling port
3. Brake fluid filling port



Brake Fluid Inspection

Brake system fault warning light



When the brake fluid is below the specified level, the instrument cluster will display the  warning light, indicating reduced braking performance. To prevent a traffic accident, pull over and stop as soon as it is safe to do so, and contact an XPENG service center immediately.

Brake fluid level inspection

1. Open the front hood .

2. Lift and detach the sealing strip located above the service cover.



3. Use a suitable tool to remove the service cover. The brake fluid reservoir will then be visible.



4. Check the brake fluid level. The brake fluid level should be between the MIN and MAX marks.

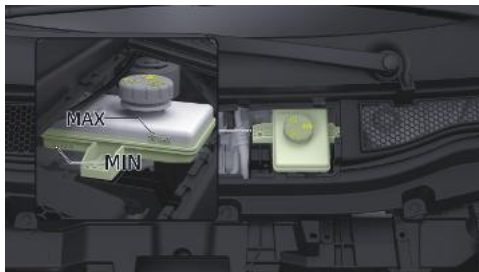

- MAX: Upper limit mark
- MIN: Lower limit mark

Check the brake fluid level within the specified maintenance intervals. If the brake fluid level falls below the MIN mark, promptly contact an XPENG service center.

 **caution**

If paintwork is inadvertently spilled when adding brake fluid, remove the paintwork as soon as possible, otherwise damage to the vehicle paintwork may occur.



warning

- Use only new brake fluid stored in an air-tight, sealed container. Never use brake fluid from a used or previously opened container. Brake fluid absorbs moisture, which reduces braking performance.
- Brake fluid is highly toxic. Keep containers tightly sealed and out of the reach of children. If accidental ingestion or exposure occurs, seek medical attention immediately.
- If brake fluid comes into contact with skin or gets into the eyes, rinse immediately with plenty of clean water.
- Brake fluid can damage painted surfaces. Immediately absorb any spilled fluid with an absorbent cloth, then wash the area with a mixture of automotive cleaner and water.
- During normal vehicle use, the brake system automatically compensates for brake pad wear, so the brake fluid level may drop slightly. This is a normal condition. However, if the fluid level drops significantly in a

short period of time, falls below the "MIN" mark, or you need to add brake fluid frequently, this indicates a leak in the brake system. Contact an XPENG service center as soon as possible to have the brake system inspected.

- Brake fluid is hygroscopic and will continuously absorb moisture from the air during use. If the water content in the brake fluid becomes too high, it can corrode the brake system and significantly lower the fluid's boiling point. This may cause vapor lock during emergency braking and reduce braking effectiveness.
- Never store brake fluid in food containers, beverage bottles, cups, or any container other than its original brake fluid container. Otherwise, it may be mistaken for a drink and cause poisoning!



Adding brake fluid

warning

When adding brake fluid, it is recommended to go to XPENG Automobile Service Center and have it handled by a professional to avoid personal injury from accidentally touching high pressure components.

Coolant Inspection

Coolant level check

Check the coolant level at the specified maintenance intervals.

1. Open the front hood .
2. Lift and detach the sealing strip located above the service cover.



3. Use appropriate tools to remove the service cover. The coolant reservoir will then be visible.



4. Check the coolant level. The coolant level should be between the MIN and MAX marks.

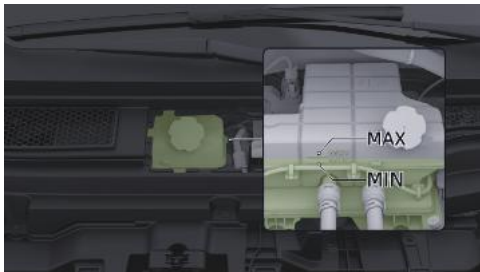

- MAX: Upper limit mark
- MIN: Lower limit mark

The coolant level should be between the MIN and MAX marks. If it is below the MIN mark, promptly add coolant approved by XPENG.

Coolant refilling

1. Use appropriate tools to remove the service cover. The coolant reservoir will then be visible.
2. First clean the reservoir cap to prevent dust from entering.
3. Unscrew and remove the reservoir cap, then add coolant. The coolant level should be between the MIN and MAX marks.

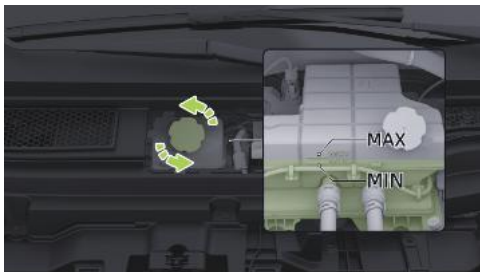

4. Reinstall the reservoir cap and the service cover by performing the above steps in reverse order.

caution

To maximize the performance and service life of the traction battery, drive motor, and air conditioner system, the cooling system uses a specific type of coolant (with different freezing points selected according to the local minimum ambient temperature).

warning

- When adding coolant, it is recommended to go to Xpeng Automobile Service Center and have it handled by a professional to avoid personal injury from accidental contact with high voltage components.
- Do not remove the cap of the coolant expansion jug, as the boiling fluid can splash out under steam and boiling fluid pressure in the hot cooling system and could cause personal burns.

Adding Windshield Washer Fluid

The wiper washer fluid filling port is in the front compartment. When the vehicle is low on washer fluid, promptly refill the wiper washer fluid.

Refilling wiper washer fluid

1. Open the front hood
2. Open the wiper washer fluid filling port cap and fill to an appropriate level as needed.



i Tips

When filling the windshield washer fluid, align with the spout and fill slowly; if the washer fluid spilled, wipe it clean.

3. After refilling, close the washer fluid filling port cap and make sure it is properly seated.

! caution

- Regularly check for clogged washer jets.
- When the temperature is below freezing point, use a cleaning solution containing

antifreeze to avoid freezing of the washer pump, washer fluid tank and washer line.

- Do not use the washer when the washer fluid tank is empty. Damage to the washer will occur.
- Do not use formulated washer fluid, this fluid may cause the windshield to create streaks, stains.

Tire Maintenance

Tire Pressure Monitoring System (TPMS)

The TPMS monitors tire conditions through tire pressure sensors installed on each wheel and issues a warning when tire pressure, temperature, or other parameters are abnormal.

When the  indicator on the touchscreen illuminates, it indicates that the system has detected abnormal tire pressure. In this case, park the vehicle in a safe location and contact an XPENG service center as soon as possible.



After each tire replacement, tire pressure must be calibrated. First, lock the vehicle and power it off, then keep the vehicle stationary for more than 17 minutes. After that, drive straight ahead at a speed above 40 km/h for 10 minutes to complete tire pressure calibration. Avoid driving in reverse while tire pressure is being calibrated.

Checking tire pressure

You can check the current tire pressures via the touchscreen by going to the “→Settings→My Vehicle” screen. If the tire pressure is lower than the specified value shown on the tire pressure label on the driver-side B-pillar, inflate the tires promptly.



caution

- It is normal for the tire pressure to increase after the vehicle has been driven for a period of time.
- If the tires require frequent inflation, go to Xpeng Automobile Service Center for service as soon as possible.
- If the tire frequently leaks or cannot be repaired properly due to cuts and other damage, replace the tire.



- If the tire leaks during driving, do not continue driving, even a short distance may cause irreparable damage to the tire.
- Make sure the tire valve cap is installed, dust and moisture will enter the valve core and may cause air leakage, if the valve cap is missing, install a new valve cap as soon as possible.

Tread Depth

There are 1.6 mm-high wear indicators in the tread patterns and distributed around the circumference of the tire. If the tire tread is worn down to the same level as the wear indicators, the tire must be replaced immediately.

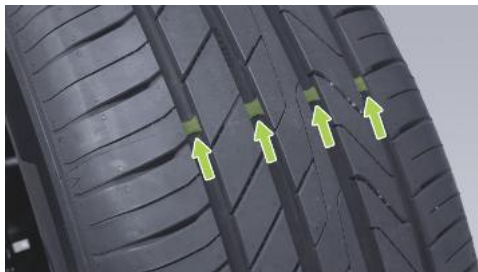

If tires with exposed wear indicators continue to be used, braking distance may increase, steering may fail, and tire rupture may occur, which can easily lead to accidents.

During everyday driving, you can reduce tire wear and extend tire service life by following these guidelines.

- Avoid rapid acceleration.
- Avoid sharp turns and hard braking.
- Drive slowly over potholes, curbs, or similar road conditions.



- If uneven tread wear is found, a four-wheel alignment inspection is required.

Tire Rotation

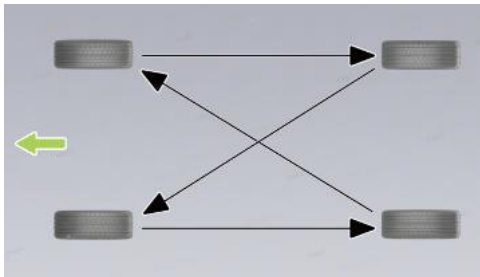

During driving, the front and rear wheels are subjected to different loads and therefore wear differently. Tire rotation can effectively reduce uneven tire wear, make wear more uniform, and extend tire service life.

If uneven tire wear is found, a tire rotation must be performed.

i Tips

The tire pressure sensor ID will need to be rewritten after tire rotation, to avoid abnormal TPMS operation please go to Xpeng Automobile Service Center for tire rotation.

Tire Replacement

Due to the effects of ultraviolet radiation, extreme temperatures, high loads, and environmental conditions, tires age over time. Tires also experience normal wear during regular acceleration, braking, and cornering. XPENG Service Centers will check tire wear during vehicle maintenance and, when necessary, recommend tire replacement.

If any of the following abnormal conditions occur with the tires (including but not limited to those listed below), you must immediately go to an XPENG service center to replace the tires:

- The tire tread has worn down to the wear indicators.



- The tire surface is scratched or punctured by foreign objects.
- There are bulges or cuts on the tire sidewall.
- The tire is severely aged and cracks have appeared on the tire surface.
- The tire surface has peeled off, exposing the cord layer.

caution

Observe the following precautions, which could result in accident and injury:

- Do not use tires that have been used by other vehicles.
- Do not mix tires with significantly different wear levels.
- Do not use tires that are not familiar with their use.
- Do not mix tires of different manufacturer, model or tread pattern.
- Do not mix tires of different construction (e.g. radial, diagonal, strapped, diagonal or twill).

- Use the same tires and wheels as the original vehicle configuration. Tyres that do not match the original specification may affect the driving aid function and the correct operation of the tire pressure monitoring system.
- Wheel balancing must be re-performed after a new tire has been replaced or after a tire repair has been carried out.

Using Snow Chains

When driving in severe conditions such as snowy or icy roads in winter, using snow chains can increase tire grip and reduce skidding. When using snow chains, you must follow these instructions:

caution

When snow chains are installed, make sure the gear is in P or the steering wheel is returned to the straight-ahead position before opening the sliding door.



Maintenance and Care

- Snow chains may only be installed on the rear wheels.
- Before installing snow chains, set the suspension to a higher level on the touchscreen via “ → **Settings** → **Vehicle** → **Drive Mode** → **Suspension Height**”.
- When driving in deep snow, it is necessary to install snow chains on the tires. This vehicle is not equipped with snow chains. You may purchase them as needed. If snow chains are installed, you must select equivalent products whose size and type match the tire specifications on the vehicle.

Snow chains may only be installed on factory 19-inch tires on this vehicle; they are not suitable for other tire sizes. The requirements for the wheel rim, tire, and snow chain thickness when installing snow chains are as follows:

Wheel rim specification	Tire specification	Snow chain thickness
-------------------------	--------------------	----------------------

19-inch wheel rim	235/55 R19	≤9 mm
-------------------	------------	-------

- When installing snow chains on the tires, make sure the vehicle can be driven in a stable, well-balanced manner under various weather conditions. Keep in mind that vehicle power output may be insufficient after snow chains are installed. Drive with caution even when road conditions are good. Do not exceed the speed limit specified for the snow chains, and do not exceed 50 km/h. Always follow the lower of the two limits.
- Snow chains must be installed in pairs. Self-tensioning snow chains are strictly prohibited.
- Do not use snow chains on dry roads. Remove the snow chains after driving onto roads without snow.
- After installing the snow chains as snugly as possible on the tires, drive 0.5–1.0 km and then tighten the snow chains again.



- If the vehicle is equipped with wheel trim covers, remove them before installing snow chains.
- If you hear the snow chains rubbing against or hitting the vehicle while driving, stop and retighten the snow chains. If this does not resolve the issue, remove the snow chains to prevent damage to the vehicle.

All-Season Tire Types

Summer tires

Summer tires are suitable for very dry and wet road surfaces, but are not suitable for winter road conditions. When driving in low temperatures or on icy and snowy roads, it is recommended to use winter tires.

All-season tires

These tires are designed to provide adequate traction in all seasons throughout the year, but may not provide the same level of traction as winter tires on icy or snowy roads. The sidewall

of all-season tires may be marked with “**ALL SEASON**” and/or “**M+S**” (mud and snow).

Winter tires

Winter tires can improve traction on icy and snowy roads. When installing winter tires, be sure to install a complete set of four tires. All four wheels must be fitted with winter tires of the same size, brand, construction, and tread pattern. Contact an XPENG Service Center for advice regarding winter tires.

When driving a vehicle equipped with winter tires, you may experience increased road noise, reduced tread life, and decreased traction on dry roads.

Traction Battery Care

Traction Battery Routine Maintenance

To maintain good performance of the traction battery, observe the following points during daily use:



- When the traction battery charge drops to 0%, you must immediately connect the charging gun and start charging.
- In winter, when ambient temperatures are low, it is recommended to keep the remaining driving range at no less than 100 km.
- While the vehicle is parked, avoid leaving XGUARD or the 12V delayed power-off function in the trunk activated for long periods to reduce energy consumption.
- **For models equipped with an LFP (lithium iron phosphate) battery:** After taking delivery of the vehicle, charge the battery to 100% as soon as possible. During subsequent use, it is recommended that you set the charging limit to "Optimal" when charging, and fully charge the battery to 100% at least once every 2 weeks or every 1,000 km, whichever comes first.

Traction Battery Characteristics

- With the traction battery in normal condition, the vehicle's driving range will still be

affected by driving habits, road conditions, ambient temperature, and the use of electrical consumers.

- Ambient temperature affects the performance of the traction battery. The vehicle should be used within an ambient temperature range of -30°C to 55°C to maintain good battery performance and extend its service life.
- During long-term parking, the traction battery will also slowly self-discharge. A low state of charge of the traction battery will shorten its service life and degrade its performance, thereby reducing the vehicle's driving range.
- Therefore, before parking the vehicle for a long period, check the remaining charge of the traction battery and keep it between 30% and 60%. If the charge is insufficient, charge the battery to a level suitable for the planned parking duration before leaving the vehicle.
- If the vehicle will be parked for a long time, it is recommended to disconnect the negative terminal of the low-voltage battery. Power up and check the vehicle every 3 months.



If the battery charge is too low, recharge it promptly; otherwise, undercharging will reduce the performance of the traction battery.

Usage Notes

The traction battery is a critical component of the vehicle. Observe the following precautions and limitations during use:

- Do not leave the vehicle parked for an extended period to avoid complete discharge of the traction battery, which may result in battery damage.
 - Never park the vehicle in extremely hot or severely cold environments, as this may damage the traction battery.
 - Keep the vehicle dry. Avoid parking it for long periods in humid environments, such as flooded or waterlogged parking lots.
 - Drive with caution on roads with deep standing water to avoid short circuits, leakage, or damage to the traction battery caused by excessive water contact.
- If you notice scraping or impact to the chassis, or detect any unusual odor from the traction battery, stop using the vehicle immediately and contact an XPENG service center.
 - Drive carefully on special road surfaces such as muddy roads, potholes, curbs, tall or wide speed bumps, and sloped sidewalks to avoid chassis impacts that may scratch or damage the traction battery.
 - It is recommended to park the vehicle in a cool, dry, and well-ventilated place, away from heat sources (such as heating pipes) and low-lying areas, and away from flammable, explosive, or corrosive materials.

Low-Voltage Battery Care

Low-Voltage Battery Usage Recommendations

The replacement interval of the low-voltage battery usually depends on the specific operating conditions of the vehicle. Good driving and usage habits can effectively extend the



battery's service life. The following situations should be avoided during daily use:

- Leaving the vehicle parked and unused for a long period will cause the low-voltage battery to become fully discharged.
- Avoid driving frequently with the traction battery almost fully depleted, as this will reduce the capacity of the low-voltage battery.
- Using non-genuine low-voltage batteries offers no after-sales guarantee and has a lower safety margin.
- Allowing the remaining driving range to fall below 30 km without recharging the vehicle in time.

Low-Voltage Battery Charging Support Function

The vehicle is equipped with an intelligent battery recharging function. When the low-voltage battery charge is low, the traction battery will automatically charge the low-voltage battery. However, when the traction battery charge is low

(remaining driving range below 30 km), charging of the low-voltage battery will stop to avoid damage caused by over-discharging the traction battery.

i Tips

When the vehicle has a range of less than 30km, the vehicle should be charged immediately. Failure to do so may result in the vehicle being unable to unlock or start due to a low voltage battery being discharged.

Vehicle Cleaning

Vehicle Washing

Regularly washing the vehicle helps protect it from environmental damage. The washing interval depends on how often the vehicle is used and the parking environment (for example: in a garage, under trees, or in direct sunlight).

Observe the following points when washing the vehicle:

Maintenance and Care



- Wash the vehicle in a shaded area and wait until the vehicle has fully cooled down before washing it, to avoid paint damage caused by direct sunlight.
- Before washing the vehicle, remove contaminants from the paint surface, such as bird droppings, resin, insects, tar spots, road salt, and industrial dust.
- When washing the vehicle in winter, carefully dry the seams around the door handles to prevent these areas from freezing.

caution

- Use dedicated car-wash detergents when washing the vehicle. Check the expiration date before use, and always store the product out of the reach of children after use.

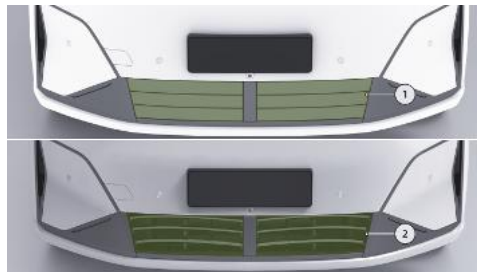

1. Active grille in the closed position.
2. Active grille in the open position.

The active grille is located below the front bumper. When washing the vehicle in low-temperature conditions, or when parking outdoors in snowy weather, the active grille louvers may ice up and fail to operate properly. The touchscreen may then show an active grille fault. This is normal and does not affect normal vehicle operation. After driving for a period of time (about one hour) or thawing the grille with a hot air gun, the fault indication will



clear automatically. If the fault remains after the louvers have thawed, contact an XPENG service center for inspection and repair.

warning

- Do not wash the vehicle while it is charging.
- Do not wash the vehicle while it is powered on.
- Keep the charging opening closed during the car wash to avoid damage to the vehicle.
- Do not flush the interior of the front compartment with water.
- Do not wash the vehicle with a hard or rough cloth, to avoid damage to the paint.
- Do not wash the vehicle without the parking brake applied.
- Do not spray hoses directly toward windows, door seals or through hub bores into the brakes.
- Do not use chemical tire cleaner as this may damage the finished surface of the wheel.

- Do not use °Hot water with a water temperature greater than 60 and do not use hot water with a cleaning concentrate.
- Do not use acid and alkaline cleaners, acid fluids can damage the surface of the vehicle and affect its appearance.

Hand washing the vehicle

When hand washing the exterior of the vehicle, follow these steps:

1. Preparation before cleaning
 - Close all doors, the trunk, and the front hood, retract the flush door handles, and check that the charge port is fully closed.
 - Close all doors and windows and turn off the auto wipers. For how to turn off the auto wipers using the wiper stalk, refer to the Wipers section.
2. Thorough rinsing
 - Rinse the body thoroughly from top to bottom with plenty of water, including



areas where dust, mud, or road salt easily accumulates (such as the wheel arches and panel seams).

3. Wipe the body with a sponge or soft cloth
 - Add a high-quality, neutral automotive cleaner to cold or lukewarm water. Using a clean, soft sponge, cloth, or soft brush, carefully wash the vehicle from top to bottom, starting at the roof.
 - For stubborn dirt, use cleaner to soften it first. If the sponge or cloth becomes heavily soiled, it is recommended to replace it with a clean sponge or cloth.
4. Rinse with clean water
 - After cleaning the vehicle, thoroughly rinse it with clean water to prevent any cleaner from remaining on the surface.
5. Dry with a soft cloth

caution

Do not continuously spray water onto the lower part of the windshield. If water enters the air

intake of the air conditioning system under the windshield, the air conditioning system may malfunction.

Using an automatic car wash machine

When washing the vehicle in an automatic car wash machine, always follow the instructions of the car wash machine operator:

1. Preparation before cleaning
 - Fold the exterior mirrors inward. For how to fold the mirrors using the touchscreen, refer to the Side Mirrors section.
 - Close all doors, the trunk, and the front hood, retract the flush door handles, and check that the charge port cover is fully closed.
 - Close all doors and windows and turn off the auto wipers. For how to turn off the auto wipers using the wiper stalk, refer to the Wipers Operation section.
 - If using a conveyor-type car wash machine, make sure the vehicle remains in N gear.



For how to shift the vehicle into N gear, refer to the Gear Selection section.

2. Start washing from the front of the vehicle
3. After washing, unfold the exterior mirrors

Using a high-pressure washer

When using a high-pressure washer to clean the vehicle, always follow the equipment operating instructions.

- Before washing the vehicle, check and confirm that all doors, the trunk, the front hood, the charge port cover, and all windows are closed.
- Keep the nozzle at least 30 cm away from the vehicle surface. Pay particular attention around the windows; if it is too close, water may enter the vehicle.
- Do not use high-pressure water, either directly or indirectly, to wash the front compartment interior.
- Avoid using a high-pressure washer or steam cleaner to clean the sensors to prevent damage to the sensors.

warning

- When washing the vehicle, do not flush the water gun at the connector on the underside of the vehicle.
- Do not use a high-pressure water gun to impact the charging flap switch area, as this may cause the cap to open.

Cleaning the wheels

1. After rinsing with a water spray gun, clean the wheels with a soft brush. Do not use a hard brush or abrasive cleaners.
2. Do not use cleaners on the wheels when they are hot (for example, after driving a long distance in hot weather).
3. Once the wheels have cooled, cleaners may be used, but they must be rinsed off immediately.

Paintwork Care

Regular waxing protects the paintwork and helps maintain the appearance of a new vehicle. Over



time, the wax layer will gradually wear away; reapply wax as needed.

i Tips

Waxing cannot restore the shine of car paint.

Parking the vehicle in a covered parking area is recommended. Long-term outdoor parking is not recommended, to avoid resin, grease, or similar substances adhering to the paint surface. Such stains can easily leave marks and are difficult to clean. If long-term outdoor parking is necessary, a thick, cotton-fleece car cover is recommended.

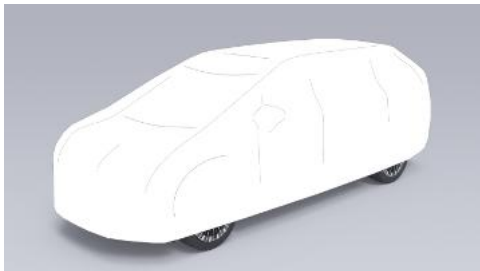

Inspecting and Cleaning Wiper Blades

Regularly inspect and clean the edges of the wiper blades, checking the rubber for cracks, splits, and roughness. If they are damaged, contact an XPENG service center to have them replaced.

! caution

- In winter or cold conditions, always check that the wiper blades are not frozen to the windshield before using the wipers. If so, defrost them first, otherwise it may damage the wiper blades and wiper motor.
- Windshield wiper blades are coated with a layer of graphite to ensure smooth wiping and prevent wiping noise. Solvent-based cleaners, hard sponges, and sharp objects can all damage the graphite layer. Damaged graphite will cause increased wiper noise and should be replaced promptly.

Contaminants on the wiper blades may reduce their effectiveness. Contaminants include ice,



spray wax from car washes, cleaning fluids containing bacteria or water repellents, bird droppings, leaves, and other organic substances. Clean the wiper blades as follows:

- Shift the gear selector to the P and make sure the wipers are turned off. On the touchscreen, go to “→**Settings**→**Vehicle**→**Service**” to enable or disable Wiper Maintenance Mode.
- Slightly lift the wiper arm away from the windshield just enough to access the wiper blade, then wipe the wiper blade with a clean cloth and a neutral cleaner.
- After cleaning, carefully lower the wiper arm to prevent it from dropping suddenly and striking the windshield, then turn off the front Wiper Maintenance Mode.

Tips

If the wiper blades are still ineffective after cleaning, they may need to be replaced.

Cleaning Washer Nozzles

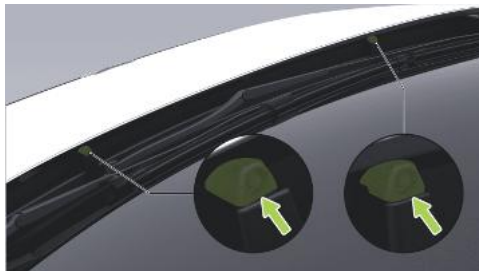

If the wiper washer nozzles are clogged, use a suitable tool to remove the obstruction from the nozzles.

Cleaning Windows and Mirrors

Contaminants on the windshield may affect its hydrophilic properties. Clean them off promptly. Contaminants include dust and oily film, bird droppings, leaves, and other debris or foreign matter.

Maintenance and Care



Clean the windows and mirrors with an alcohol-based glass cleaner, then wipe the glass surfaces dry with a clean, lint-free soft cloth.

Use a small brush to remove accumulated snow from the windows and mirrors. Use a de-icing spray to remove ice buildup. A de-icing scraper may also be used, but exercise particular care to avoid damaging components, and always scrape in the same direction when using it.

caution

- Do not use hot water to remove ice and snow from the windshield and rearview mirrors, as this may cause the glass to shatter.
- Do not use cleaning products containing ammonia or chlorine, such as household window cleaners, as these will accelerate the aging of the wiper blades.
- Do not use water-repellent materials (such as wax or ceramic coatings) to clean the windshield, as this will increase the water

repellency of the glass surface and affect its cleanliness.

- If there is any residual rubber, grease, or silicone on the glass, it must be removed with a dedicated car window cleaner or silicone cleaner.

Cleaning Lights

At normal ambient temperature, clean with clean water and a soft cloth. For stubborn dirt, you may use plastic cleaner or other mild cleaners, and then rinse off the cleaner with water.

caution

- Do not use dry cloths, sponges, or other dry items to clean vehicle headlights, as this may scratch them.
- Do not wax or polish the surface of vehicle headlights, as this may damage them.
- Do not use cleaning agents directly on hot surfaces; rinse with water to cool them down before cleaning.



- Do not use cleaning agents containing alcohol or organic substances (such as adhesive removers, glass cleaners, paint cleaners, foam cleaners, thinners, de-icing agents, etc.) to clean vehicle headlights, as this may damage them.

Interior Cleaning

Interior Cleaning

Frequently inspect and clean the interior to keep it looking neat and like new, and to prevent premature wear.

caution

- It is recommended to use automotive products that do not contain plasticizers. If the plasticizer content is too high, it may react with PU interior materials and cause issues such as bubbling of interior trim surfaces.
- Using solvents (including alcohol), bleach, citrus cleaners, naphtha, silicone-based

products, or additives will damage the interior.

- Do not use highly corrosive cleaners such as strong acids or strong alkalis, to avoid corrosion or discoloration of the interior.
- Do not wipe the door trim panel with wet wipes, damp cloths, or cleaners. During vehicle use (for example, in rainy weather or when washing the vehicle), take protective measures to avoid water entering the door trim panel, otherwise internal electrical components may fail.

warning

It is strictly forbidden to directly wash the cabin and trunk with large amounts of water, as this may damage electrical components and affect the normal use of the vehicle.

Cleaning Plastic Components

Clean plastic surfaces with a clean, soft cloth and water. If necessary, use a dedicated plastic cleaner for wiping and cleaning.



warning

Polishing the upper surface of the dashboard is strictly prohibited. Polished surfaces are prone to reflection and may interfere with the driver's visibility.

Seat Cleaning

1. Use a vacuum cleaner to remove dust.
2. Clean leather surfaces with a clean, soft cloth and water.
3. Dry any remaining moisture with a soft, dry cloth.
4. If the above cleaning is not sufficient to remove the stains, use a dedicated leather cleaner. After wiping with the cleaner, promptly dry the area with a soft, dry cloth.

caution

Do not place a soft cloth soaked in detergent on any part of the interior for an extended period of time, as this may cause fading or damage to the interior fabrics.

Carpet Cleaning

Use a vacuum cleaner with a soft brush attachment to remove dust and loose dirt.

For stubborn stains, first try removing them with water or soda water. Before cleaning, choose an appropriate method to remove stains:

- For liquid stains: gently blot the remaining stain with a paper towel, allowing as much of the stain as possible to soak into and be absorbed by the paper towel, then clean with an interior cleaner.
- For solid, dry stains: remove as much as possible by hand first, then use a vacuum cleaner to remove the remainder.

caution

- To extend the life of your car carpets and facilitate cleaning, please use genuine floor mats approved by XPeng Motors. Clean the floor mats regularly and ensure they are properly installed. Replace the floor mats promptly if they are excessively worn.



- To avoid interfering with the pedals, ensure the driver's floor mat is securely fastened and never stack floor mats on top of each other. The floor mat should always be placed on top of the vehicle's carpet surface.

Seat Belt Cleaning

1. Slowly pull the seat belt out and keep it extended.
2. Use a sponge soaked with a mild soapy solution to wipe dirt from the surface of the seat belt.
3. After wiping, allow the seat belt to air dry in a shaded place, then retract the seat belt.

caution

- If you find any damage to the airbags or seat belts, please contact XPeng Motors Service Center immediately.
- Do not allow any water, cleaning agents, or fabrics to enter the seat belt system.

- Do not use any type of cleaning agent or chemical cleaner to wash the seat belts, as this may damage the seat belt webbing and affect their function.

clean mode

Cleaning the instrument display and touchscreen

1. Before cleaning the screen, on the touchscreen go to “ → **Settings** → **Display** → **Clean Screen**” and enable Screen Cleaning Mode. The touchscreen will turn off to prevent accidental touches while cleaning.
2. Use a dedicated, lint-free, soft cleaning cloth to clean the touchscreen and instrument display.
3. After cleaning the screen, press and hold the “**Press and hold to exit**” button on the touchscreen. When the countdown ends, Screen Cleaning Mode will turn off.



Cleaning the rear entertainment screen

1. Before cleaning the screen, make sure the rear entertainment screen is turned off to prevent accidental touches while cleaning.
2. Use a dedicated, lint-free, soft cleaning cloth to clean the rear entertainment screen.

caution

- Do not use cleaning agents such as glass cleaners, damp rags or dry, static-coated rags such as a recently cleaned ultra-fine microcloth.
- Do not use acid-alkali, deoxygenation, sodium hypochlorite (84 disinfectant) and other corrosive liquids to clean the central control screen.



Traffic Accident Guidelines

Stopping the Vehicle in the Event of a Malfunction

If the vehicle malfunctions, and only when it is safe to do so, drive the vehicle to a safe location, press the brake pedal, and bring the vehicle to a complete stop on a safe section of the road.

1. Shift the gear position to P and turn on the hazard warning lights to alert surrounding traffic.

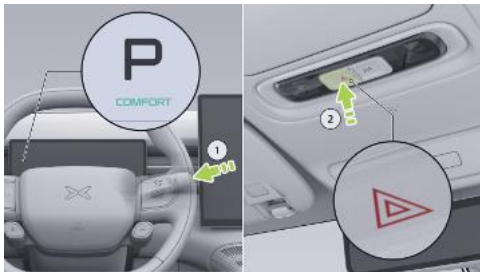

2. Open the vehicle's trunk, take out the safety vest, and put it on.
3. Take out the warning triangle, unfold it, and place it behind the vehicle to warn following traffic to slow down and avoid the vehicle.
4. After placing the warning triangle, leave the vehicle as soon as you can once you have ensured that the surrounding environment is safe, keep a safe distance, and contact an XPENG service center or call the customer service hotline at 400-783-6688 for assistance.

warning

- When handling a vehicle accident, regardless of the lighting conditions, be sure to wear reflective clothing as required to attract the attention of pedestrians or other vehicle drivers.
- Do not set up warning signs without wearing a reflective vest.



Onboard Tools

The onboard tools (such as the warning triangle and tool kit) are located under the trunk and can be accessed by opening the vehicle's trunk.

This vehicle is supplied with the following onboard tools. After use, clean them promptly and return them to their original locations.

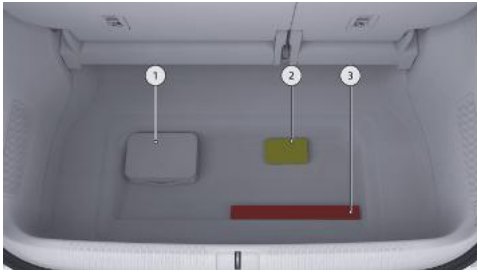

1. Onboard tool kit: air pump, tow hook, and center wheel cap removal tool.
2. Reflective vest.
3. Warning triangle.

Warning triangle installation method

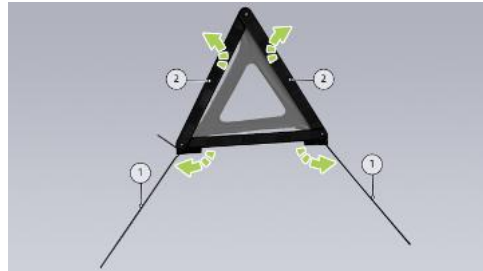

1. Unfold the four supports ① at the bottom of the warning triangle.
2. Unfold the two side flaps ② of the triangle and fasten the snap at the top of the triangle.
3. Set the supports on the ground and position the side with the reflective material facing rearward.

Depending on the type of road surface and ambient visibility, place the warning triangle at



Breakdown Assistance

the distances behind the vehicle shown in the table below:

Road type	Placement distance	
	Daytime	At night
Expressway	≥ 150 m	≥ 150 m
Ordinary road	≥ 50 m	≥ 80 m

Tire inflation

1. Remove the air pump from the tool kit in the trunk.
2. Remove the air hose and the power cord from the sides of the air pump.



3. Install the air pump hose onto the tire valve and tighten it.

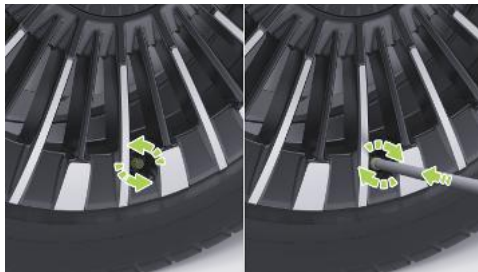

Breakdown Assistance



4. Connect the air pump power cord to the vehicle's 12 V power outlet.



5. Turn on the switch; the air pump will begin inflating the tire.
 - Monitor the pressure gauge and stop once the tire pressure reaches the specified value.

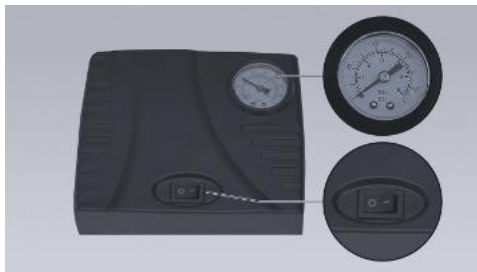

- For the standard tire pressure corresponding to the tire specification, refer to the tire pressure label on the driver-side B-pillar.



6. Turn off the air pump.

Center Wheel Cap Removal Tool – Instructions for Use

Remove the wheel center trim cover by following these steps:

1. Before replacing the tire, take the center wheel cap removal tool from the onboard tool kit in the trunk.

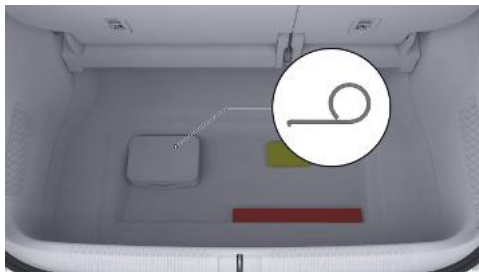

2. Insert the tool into the removal hole located at the edge of the wheel center trim cover. Operate carefully when inserting into the hole to avoid scratching the wheel center trim cover.

Breakdown Assistance

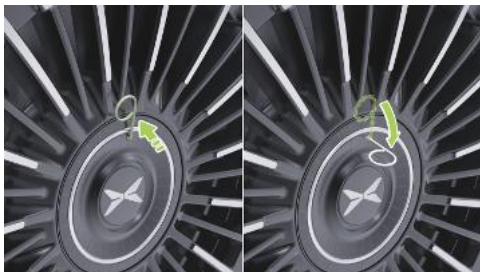

3. Pull firmly outward to remove the wheel center trim cover.



Install the wheel center trim cover by following these steps:

1. Before installation, align the locating cylinder on the wheel center trim cover with the locating hole on the wheel rim.



2. Press the wheel center trim cover so that it snaps into place. Ensure it is securely engaged to prevent the wheel center trim cover from coming off while the vehicle is in motion.



Warnings

If the vehicle is severely damaged in an accident, observe the following warnings to ensure personal safety:

- Do not touch the high-voltage wiring harnesses or any high-voltage components on the vehicle.
 - Do not come into contact with any leaking fluids.
 - Do not attempt to inspect the vehicle yourself.
- If the vehicle needs to be towed, contact an XPENG service center.
 - If the vehicle has been submerged in water, do not power it on again. The traction battery may have an internal short circuit. To ensure personal safety and avoid further damage to the vehicle, immediately contact an XPENG service center to have the traction battery system inspected, and have qualified personnel assess the extent of any battery damage.
 - If smoke is coming from the vehicle, move away from the vehicle immediately and contact an XPENG service center promptly.
 - If the vehicle catches fire, move away from the vehicle immediately and contact emergency services. Inform them that the vehicle is a new energy pure electric vehicle.
 - If the touchscreen indicates a traction battery system fault, pull over safely to the side of the road, move away from the vehicle, and contact an XPENG service center for assistance.

Breakdown Assistance



- If any occupants are injured, contact emergency medical services according to the severity of the injuries.
- If the vehicle experiences an underbody impact, collision, or similar incident, the internal structure of the traction battery may be damaged, creating a serious safety hazard. Immediately contact an XPENG service center to have the traction battery system inspected, and have qualified personnel assess the damage.

Roadside Assistance Service

Information Required for Assistance

When you call, please provide the rescue personnel with the following information:

- Your name.
- The license plate number and the vehicle color.
- The Vehicle Identification Number (VIN).

- A description of the problem and the exact location.
- A mobile phone number at which you can be reached.

caution

- Do not independently arrange rescue or repair services through any third party. To ensure that you receive the service provided by XPENG Roadside Assistance, please contact an XPENG service center for help.
- If towing service is required, make sure to remove all personal belongings from your vehicle before the tow truck arrives.

Emergency Rescue Service (SOS)

Introduction to SOS

SOS is the vehicle's intelligent emergency call system. It can automatically or manually place an emergency call in the event of an accident or other emergency, providing information such as the vehicle's location and the



occupants' condition so that rescue personnel can reach the scene promptly and assist trapped occupants.

Manual Emergency Call

The SOS switch and indicator light are located on the front reading light panel. In an emergency, you can manually request emergency rescue service by pressing the SOS switch twice within 3 seconds.



SOS switch indicator light information:

- Illuminated green: The emergency call is waiting to be connected or is in the process of connecting.
- Illuminated red: A system malfunction has occurred. Contact an XPENG service center or call the customer service hotline at 400-783-6688 for assistance.

warning

Do not press the SOS switch except in emergency situations.

Automatic Emergency Call

The SOS switch and indicator light are located on the front reading light panel. In an emergency, you can manually request emergency rescue service by pressing the SOS switch twice within 3 seconds.



SOS switch indicator light information:

- Illuminated green: The emergency call is waiting to be connected or is in the process of connecting.
- Illuminated red: A system malfunction has occurred. Contact an XPENG service center or call the customer service for assistance*(If applicable).

warning

Do not press the SOS switch except in emergency situations.

Procedures When the Vehicle Cannot Be Moved

Using Tow Hook

If the vehicle cannot be moved due to a malfunction, it may be transported using a flatbed tow truck. Proceed as follows:

1. Open the vehicle's trunk, remove the tow hook, and close the trunk.

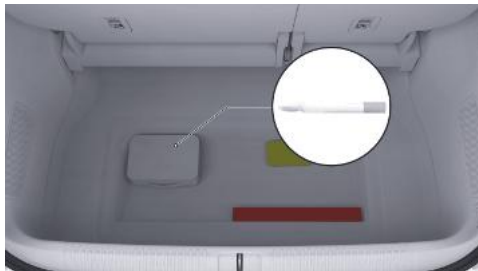

2. Press the lower left corner of the tow hook cover. When the cover pops up, open it.



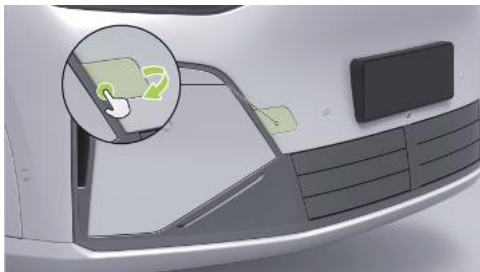

Breakdown Assistance



3. Insert the tow hook and then rotate it clockwise until it is firmly secured.



4. Attach the tow rope to the tow hook.
5. Make sure the charging gun is not plugged in and the vehicle is in gear position P or N, then press the brake pedal. On the touchscreen, go to “ → **Settings** → **Vehicle** → **Maintenance** → **Towing Mode**” and select “Turn on Rescue Mode.” After Rescue Mode is turned on, the vehicle will shift to N and release the parking brake, and it will not be possible to shift to D or R. Pay attention to safety!
6. Tow the vehicle onto the flatbed truck.
7. After confirming that the vehicle is at a complete stop, on the touchscreen go to “ → **Settings** → **Vehicle** → **Maintenance** → **Towing Mode**” and select “Turn off Rescue Mode.” Press the P gear switch on the gear selector to shift to P and secure the vehicle.
8. Use straps to secure the wheels.



⚠ caution

Tire straps should only be attached to the tire tread for securing. Do not use horizontal or crisscrossing methods to secure the tire, as this may entangle other parts and cause vehicle malfunction.

9. After use, restore the tow hook cover to its original position, clean the tow hook promptly, and put it back in its original location.

⚠ caution

- The traction hook must be securely screwed into the threaded hole; otherwise, the traction hook may slip out of the threaded hole during traction.
- The rope must be tied to the tow ring only, and not to any other part of the vehicle, otherwise it will damage the vehicle.
- Extreme caution must be exercised when using a tow hook to tow a vehicle. Start and drive the vehicle slowly and smoothly. Excessive pulling force will cause impact load, which may result in personal injury or vehicle damage.

Towing Precautions

Before the vehicle is towed, be sure to contact an XPENG service center.



Breakdown Assistance

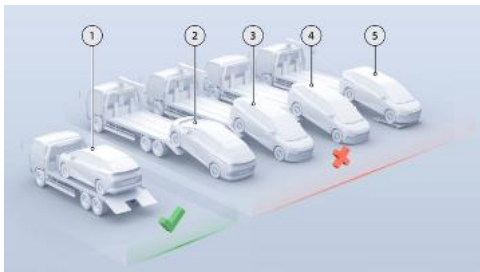

Before the vehicle is towed, be sure to contact an XPENG service center. Use towing method ① in the illustration, with all four wheels off the ground. Towing methods ②, ③, ④, and ⑤ shown in the illustration are prohibited.

caution

- The vehicle can only be towed away from the scene after ensuring there is no safety risk. If the vehicle's battery is deformed, leaking, or smoking, the safety risks should be addressed first.

- If a platform-type cargo truck cannot be used for towing, a rigid connection method can be used to urgently tow the vehicle to a safe area and wait for rescue.
- When using rigid towing, long-distance towing should be avoided, and the towing speed should not exceed 5 km/h.
- When towing a vehicle onto a flatbed rescue vehicle, use restraint straps and wheel chocks to secure the tires in case of an accident.

warning

- When towing a vehicle, no one is allowed to stand in front of or behind the vehicle, as this may cause an accident.
- When towing a vehicle, no one may ride in the vehicle, otherwise an accident may occur.
- Never allow the wheels to touch the ground while transporting the vehicle. Doing so can cause serious damage and overheating. In



rare cases, extreme overheating may cause surrounding components to catch fire.

Emergency High-Voltage Shutoff Procedures

Primary Disconnection Method

warning

- The operation of cutting the high voltage circuit requires a professional person, do not operate it yourself.
- Always wear the appropriate personal protective equipment before operating, and use insulated tools when working at high pressures.

After entering the vehicle, you can use the following methods to perform an emergency power-off:

1. Emergency power cut-off when the vehicle is stationary:

- On the touchscreen, go to “ → **Settings** → **Vehicle** → **Maintenance**”, tap “**Power Off**”, read the pop-up message, then tap “**Confirm**” to turn off the high-voltage power and power off the vehicle.
- Press and hold the SOS switch for 5 seconds to power off the vehicle directly.

2. Using a suitable tool, remove the battery service cover to access the battery negative cable.

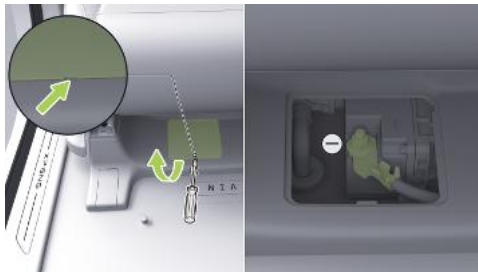

3. Using a suitable tool, loosen the battery nut and disconnect the battery negative cable.



Breakdown Assistance

After disconnection, wrap it with electrical insulating tape to prevent accidental contact and reconnection.

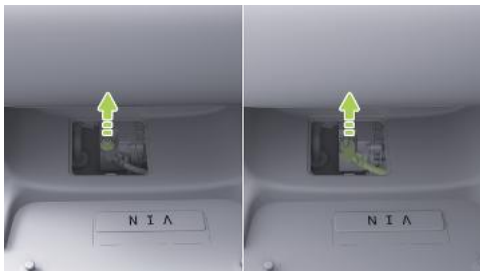

Alternative Disconnection Method

Alternative Disconnection Method

If the above operations cannot cut off the high-voltage power, you can try the following alternative methods:

1. Pull the front hood release handle located at the lower left of the instrument panel twice in

succession; after the hood pops up slightly, it will be unlocked. Lift the front hood upward and use the manual support rod to hold the hood open.



2. Remove the driver-side and passenger-side wiper arm assemblies.
3. Remove the rear sealing strip of the front hood.
4. Remove the upper covers on both front fenders.
5. Remove the sealing parts of the wiper covers on both sides.

Breakdown Assistance



6. Remove the wiper cover assembly.
7. Locate the low-voltage service switch in the front compartment.



8. Press release tab ①, then pull in the direction of the arrow to remove the low-voltage service switch.

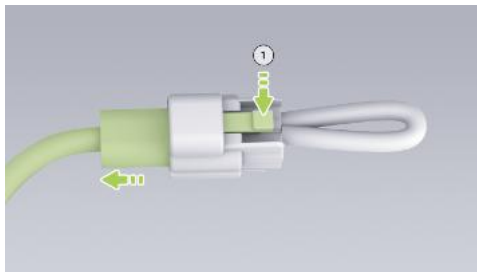

warning

- Even after the high-voltage power has been disconnected, touching the power battery components is strictly prohibited. If it is absolutely necessary to operate the power battery components, be sure to wear the appropriate personal protective equipment.
- If any high-voltage components are found to be damaged, be sure to wrap the damaged area with insulating tape.



Procedures for Low Battery Conditions

Symptoms of Low Charge in the Low-Voltage Battery

- The vehicle cannot be started.
- The headlights are dimmer than normal.
- The horn does not sound or the sound is weak.

warning

- Batteries must not come into contact with open flames or static electricity. Otherwise, the flammable gases produced by the battery may be ignited by sparks, causing an explosion. Before handling batteries, please be sure to carefully read and comply with the relevant safety warnings and instructions for battery operation.
- The auxiliary power supply voltage must be the same as the voltage and capacity of the vehicle's battery; otherwise, it may cause an explosion.

Battery Terminals

The positive and negative terminals are located in the trunk. Open the trunk and remove the service cover to see them.

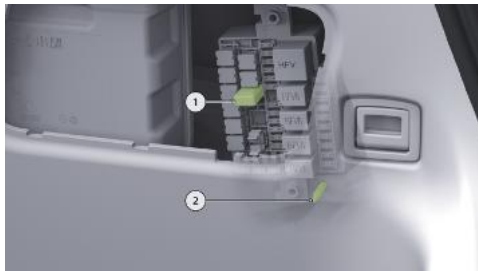

1. Positive terminal
2. Negative terminal

Jump-Start Procedure

The vehicle's battery has a lockout function. When the battery power is too low to start the vehicle, first pull and hold the front passenger

Breakdown Assistance



door handle for more than 5 seconds to wake up the battery, then immediately use the key to unlock and open any door to power on the vehicle; otherwise, the battery will enter the lockout mode again.

If pulling and holding the front passenger door handle for more than 5 seconds still does not wake the battery and the vehicle cannot be started, you can start the vehicle using the following method:

1. With the vehicle in Park, turn off all unnecessary electrical consumers on both the rescue vehicle and the disabled vehicle. Open the trunk and use a suitable tool to remove the trunk service cover.



2. Locate the positive terminal and remove the protective cap from the positive terminal.





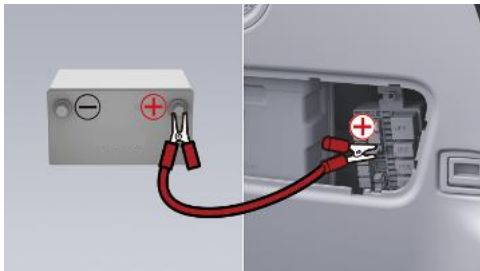

Breakdown Assistance

3. Connect one end of the red cable to the positive terminal (+) on this vehicle's fuse box, and the other end to the positive (+) terminal of the auxiliary power source.

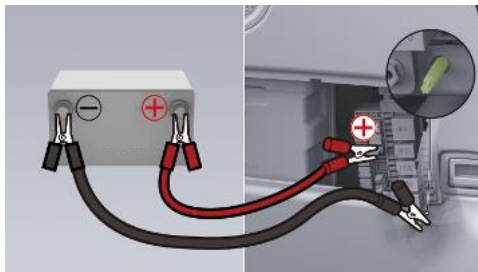

4. Locate the negative terminal. Connect one end of the black cable to this vehicle's battery negative (-) terminal, and the other end to the negative (-) terminal of the auxiliary power source.



5. After connecting the auxiliary power source, if the touchscreen is on, you must go to “→Settings→Vehicle→Maintenance” on the touchscreen and tap “Power Off”, or press and hold the SOS switch for 5 seconds to power off the vehicle; otherwise, the vehicle cannot be started.
6. After the vehicle has been powered off, make sure the remote key or NFC card key is inside the vehicle, or that the phone Bluetooth key is connected to the vehicle, then depress the brake pedal and shift into gear to complete startup.



caution

Emergency auxiliary power supplies cannot maintain high power output for extended periods. Generally, the auxiliary power supply should be connected and restarted within 30 seconds; otherwise, a power-on reconnection procedure must be performed.

7. After the vehicle has started successfully, disconnect the connected cables in the

reverse order, stow them properly, and reinstall the rear trunk service cover.

warning

- Improper use of connecting cables may cause the battery to explode, resulting in personal injury.
- Do not touch high-voltage components during operation to avoid electric shock.



Vehicle Emergency Rescue

Basic Vehicle Information





Vehicle model		X9
Overall dimensions	Length (mm)	5316
	Width (mm)	1988
	Height (mm)	1785
Rated passenger capacity (persons)		7
Maximum design gross mass (kg)		3325/3300/3320/3310

Protective Equipment for Emergency Responders

The vehicle's powertrain is driven by a traction battery. In the event of a severe collision, there may be high-voltage leakage, battery pack damage, and chemical liquid leakage. Therefore, during rescue operations on the vehicle, emergency responders must wear appropriate protective equipment to ensure personal safety.





warning

- When emergency rescue personnel operate high-voltage components, a supervision mechanism should be implemented, with one person supervising and one person operating. It is prohibited for two or more people to work at the same time. When the operator is working, other personnel are prohibited from touching the operator.







Breakdown Assistance

- Emergency rescue personnel are prohibited from wearing metal jewelry during rescue operations.

Equipment name	Illustration	Explanation	Purpose
Insulating protective clothing		Insulation rating ≥ 1000 V	Used to prevent high-voltage electric shock and resist the heat generated by electric arcs.
Insulating gloves		Insulation rating ≥ 1000 V	Used to prevent high-voltage electric shock
Insulating shoes		Insulation rating ≥ 1000 V	Used to prevent high-voltage electric shock

Breakdown Assistance



Insulated tools		Insulation rating ≥ 1000 V	High-voltage-related operations
Insulating tape		Insulation rating ≥ 1000 V	Wrap around all exposed or damaged conductors
Insulated rescue hook		Insulation rating ≥ 1000 V	Pull and rescue an electric shock victim
Fire blanket		A1	Firefighting



Breakdown Assistance

Safety helmet		T4-class electrically insulating proximity warning helmet	High-voltage warning and head protection
Protective face shield		PVC transparent lens	Splash protection
Safety goggles		PVC transparent lens	Splash protection
Acid- and alkali-resistant gloves		Must comply with the requirements of the standard for solvent-resistant protective gloves.	Used in the event of electrolyte leakage



Fire extinguisher		Extinguish the fire using appropriate firefighting equipment (water or fire extinguisher) according to the type of fire.	Firefighting
-------------------	---	--	--------------

Vehicle Fire

warning

If a vehicle catches fire, never touch any part of the vehicle directly. The fire should be handled by professional rescue personnel wearing appropriate safety equipment.

When a vehicle fire is small and under control, appropriate extinguishing agents should be used: dry sand, dry chemical powder, or carbon dioxide.

When a vehicle catches fire or the power battery is severely damaged by compression, bending, or other means, and the fire spreads

rapidly or gets out of control, it is necessary to notify rescue personnel to use a continuous and large amount of fire-fighting water to extinguish the fire for 30 minutes (windows can be broken to flush the fire). At the same time, to prevent the fire from spreading, any flammable materials in the vicinity should be kept away from the burning vehicle.

Once the fire is extinguished, it needs to be monitored closely to prevent reignition.

Vehicle Immersed in Water

When handling a water-submerged vehicle, professional rescue personnel must wear appropriate personal protective equipment, first



pull the vehicle out of the water, and then properly shut off the high-voltage power.

caution

- It is recommended that vehicles not remain in deep water for extended periods while driving through water, as this can easily damage the vehicle's high-voltage components.
- After the vehicle is salvaged, it needs to be left to stand for at least 30 minutes. During this time, the battery pack temperature needs to be monitored in real time to ensure that there is no thermal runaway of the battery before the vehicle is towed away.

warning

The extent of damage to a flooded vehicle may not be obvious. When handling a flooded vehicle, rescuers must wear appropriate rescue protective equipment to avoid the risk of electric shock, which could result in serious personal injury or death.

Battery Leakage

If the traction battery leaks (with visible liquid outflow), handle it as follows:

- If a small amount of electrolyte leaks, keep away from ignition sources, absorb it with absorbent pads and place them in a sealed container, or dispose of them by incineration.
- If a large amount of leakage occurs, collect it together and treat it as hazardous chemicals. Calcium gluconate solution may be added to deal with toxic gases.

warning

- Before storing power batteries safely, their temperature must be monitored continuously. If abnormal temperature rise occurs, physical cooling measures must be taken to prevent fire or explosion.
- If the body accidentally comes into contact with the leaked liquid, immediately flush with plenty of water for 10-15 minutes. If there is no improvement or if symptoms of



discomfort appear, seek medical attention immediately.

Emergency Evacuation of Occupants

If the vehicle is submerged in water, involved in a collision, or catches fire, immediately move away from the vehicle and do not attempt to rescue the vehicle yourself.

Passengers should attempt emergency evacuation as follows:

- Try to open the door using the normal method.
- If the door cannot be opened by normal means, try opening the door using the emergency method:
 - Front-row passengers should perform emergency opening of the front doors [See 100 page](#).
 - Rear-row passengers should perform emergency opening of the sliding doors [See 108 page](#).

- If the doors still cannot be opened, call the emergency phone and wait for rescue personnel.

Cutting Locations

warning

1. When cutting into a vehicle body, always use appropriate tools such as hydraulic cutters and wear suitable personal protective equipment. Failure to follow these instructions can result in serious personal injury or even death.
2. Regardless of the high-voltage disconnection procedure used, always assume that all high-voltage components are energized! Cutting, crushing, or touching high-voltage components can result in serious personal injury or even death.
3. If it is necessary to cut into the vehicle body or use hydraulic shears to rescue occupants, first disconnect the



Breakdown Assistance

high-voltage power and wait at least 3 minutes.

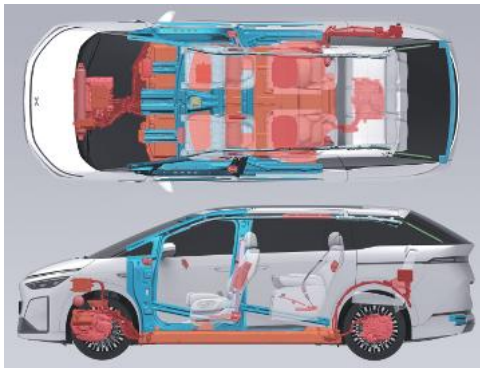

During emergency rescue, if cutting, spreading, or piercing parts of the vehicle is required, avoid the traction battery, drive motor, high-voltage cables, high-voltage electrical equipment, and airbag-related components, as well as other high-temperature and high-voltage areas. All

areas indicated in red in the illustration are prohibited cutting zones.

Normally, avoid cutting airbag-related components, but cutting may be performed under the following circumstances:

- When the driver/front passenger front airbags, front side airbags, driver far-side airbag, second-row left and right seat cushion airbags, and front and rear head curtain airbags have deployed.
- After disconnecting the 12 V battery negative cable and cutting off the high-voltage power for more than 3 minutes.

In addition, the blue areas are high-strength steel zones, and these steel sections cannot be cut with ordinary tools.

Vehicle Information



Vehicle Identification Information

Exterior Identification Information

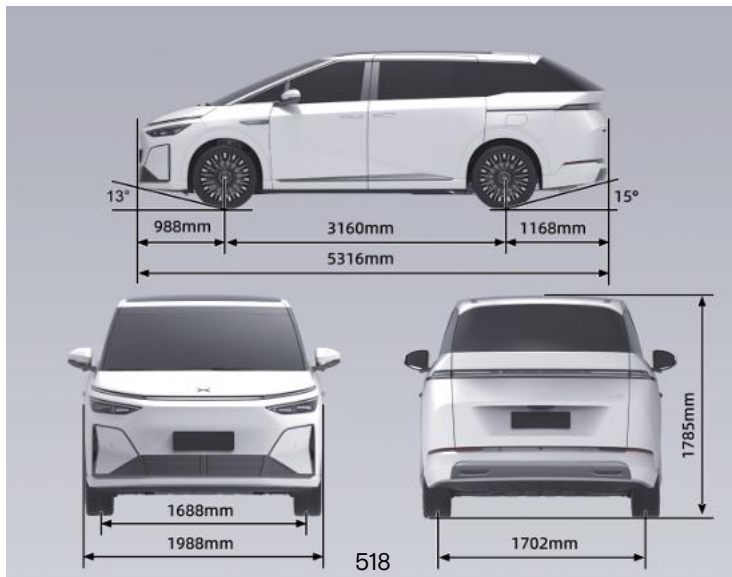





Vehicle Safety Labels

The locations of the related safety signs are shown in the figure:



1. The coolant filling sign is located in the front compartment.
2. The air conditioner system warning sign is located in the front compartment.





- The airbag warning sign is located on the front passenger side sun visor and is visible when the sun visor is lowered from the front passenger side ceiling.
- The charging high-voltage sign is located on the charging port sealing cover.

warning

These signs are meant to alert you to potential hazards that could cause serious injury. Please read these signs carefully. If any signs are missing or illegible, please contact XPENG Motors Service Center for replacement.

High-Voltage Safety Labels

Warning Sign Name	Warning Sign Symbol	Warning Sign Description
High-voltage warning sign		Do not touch high-voltage components. Danger!
High-voltage component warning sign 1		High-voltage components. Risk of danger. Do not touch high-voltage components without wearing protective equipment. Risk of electric shock!



Vehicle Information

High-voltage wiring harness
sign



The vehicle's high-voltage components are all connected by orange high-voltage wiring harnesses. Do not touch the high-voltage components or the orange high-voltage wiring harnesses without wearing protective equipment!



Sensor Window



The sensor window is located on the windshield.

warning

- The Radio wave windshield must not be obstructed.
- When affixing necessary markings for traffic regulations, choose a location around the Radio wave windshield.

Vehicle Identification Number (VIN)



The vehicle identification number is stamped beneath the front passenger seat.

Other vehicle identification numbers are located at the following positions on the vehicle:



1. Affixed to the inside of the front hood.
2. Affixed to the lower left corner of the front windshield.
3. Affixed to the left B-pillar.
4. Affixed at the left rear wheel housing.
5. Affixed to the inner panel of the right rear door.
6. Affixed to the left side of the trunk lid.
7. Affixed to the upper cross member of the rear end panel.

Vehicle Nameplate

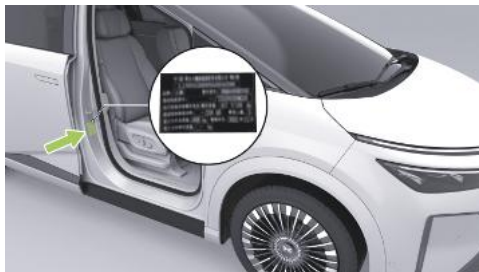

The vehicle nameplate is located on the right B-pillar and can be seen after opening the right-side door.

Drive Motor Model and Serial Number

The front drive motor* model and serial number are indicated at the following locations:

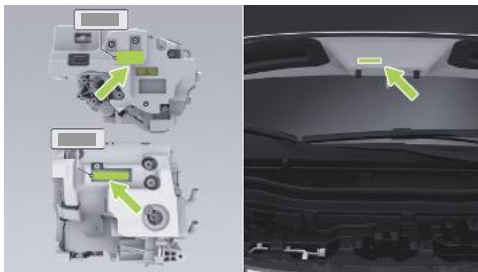

- The drive motor model and serial number are indicated on the drive motor housing and on the drive motor nameplate label.
- The drive motor model and serial number label is affixed to the inner side of the front hood.

The rear drive motor model and serial number are indicated at the following locations:

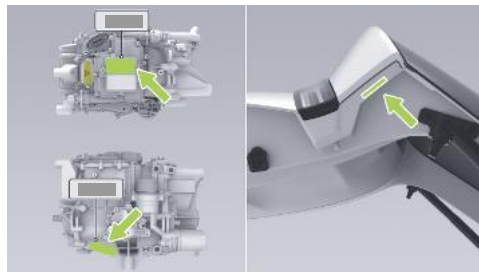

- The drive motor model and serial number are indicated on the drive motor housing and on the drive motor nameplate label.
- The drive motor model and serial number label is affixed to the right side of the trunk lid.



Vehicle Information

OBD



The OBD port for reading the electronic VIN is located at the lower left of the instrument panel. The electronic VIN and vehicle status information and other data can be read using the original factory diagnostic tool or factory-approved diagnostic equipment.



Vehicle Technical Specifications

Dimensions

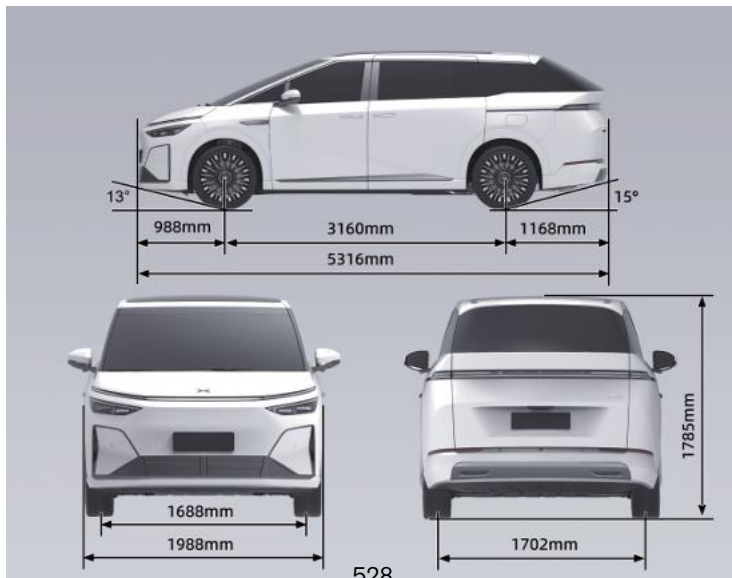



Vehicle Information

Overall dimensions	Length (mm)	5316
	Width (mm)	1988
	Height (mm)	1785
Track width	Front track width(mm)	1688
	Rear track width(mm)	1702
Wheelbase (mm)		3160
Front overhang (mm)		988
Rear overhang (mm)		1168
Number of occupants (persons)		7
Approach angle (fully loaded) (°)		13
Departure angle (fully loaded) (°)		15

Vehicle Information



i Tips

The exterior rearview mirrors (one on each side) are not included in the outer width

dimension. The allowable tolerance range for the overall vehicle dimensions is $\pm 3\%$.

Weight Specifications

Item name	Standard-range 2WD		Long-range 2WD		Long-range 4WD	
	With tow hook	Without tow hook	Without tow hook	With tow hook	Without tow hook	With tow hook
	Without tow hook					



Vehicle Information

Curb weight (kg)		2750	2775	2690	2720	2745	2770
Curb	Front axle (kg)	1401	1349	1371	1366	1372	1366
	Rear axle (kg)	1349	1381	1319	1354	1373	1404
Gross vehicle weight rating (kg)		3325	3325	3300	3300	3320	3310

Vehicle Information



Maximum	Front axle (kg)	1 5 2 2	1505	1504	1484	1493	1480
	Rear axle (kg)	1 8 0 3	1820	1796	1816	1827	1830

i Tips

The tolerance range for quality parameters is $\pm 3\%$, except for the maximum total mass.



Battery Specifications

Item name		Unit	Standard-range 2WD	Long-range 2WD	Long-range 4WD
Cell	Type	/	LFP	NCM	NCM
	Nominal voltage	V	3.16	3.77	3.77
	Rated capacity	Ah	139	165.8	165.8
Power Battery	Rated voltage ¹	V	682.56	663.52	663.52
	Rated capacity ¹	Ah	139	165.8	165.8
	Rated energy ¹	Wh	94875	110011	110011
	Mass	kg	696±10	622±10	622±10

1: Calculated at 1/3C discharge.



Electric Drive Unit Specifications

Item name		Front electric drive system	Rear electric drive system*
Drive type		Front-wheel drive	Four-wheel drive
Drive motor	Type	Permanent magnet synchronous	AC induction
	Rated power (kW)	110	40
	Rated torque (N·m)	170	51
	Rated speed (rpm)	6190	7500
	Maximum power (kW)	255	140
	Maximum torque (N·m)	450	200
	Maximum speed (rpm)	18000	15000
Reducer	Model	1ETP45A	1ETC18A
	Number of gears	1	



Chassis Specifications

Performance parameters

Minimum turning diameter (cm)	11
Maximum speed (km/h)	200
Maximum gradability (%)	30

Vehicle Information



Wheels and tires

Model	Tire pressure (kPa)	
	Unladen / half load	Full load
235/50R20	270	310
	270	310

Wheel dynamic balance (after balance weights are attached)	Front wheel inner side (g)	≤8
	Front wheel outer side (g)	≤8
	Rear wheel inner side (g)	≤8
	Rear wheel outer side (g)	≤8



Brakes and suspension

Type	Hydraulic, X-type circuit layout
Power assist type	Electric power assist
Brake pedal free play or idle travel (mm)	4
Front brake pad wear limit (excluding backing plate) (mm)	2.5
Rear brake pad wear limit (excluding backing plate) (mm)	2.5
Front brake disc wear limit (mm)	30
Rear brake disc wear limit (mm)	22
Front suspension type	Double wishbone independent suspension
Rear suspension type	Rear H-arm multi-link independent suspension
Air suspension air reservoir rated working pressure (bar)	20

Vehicle Information



Four-wheel alignment parameters

Item	Alignment parameters
------	----------------------



Vehicle Information

Four-wheel alignment	Front wheels	Single-side front wheel toe	$3' \pm 3'$
		Single-side front wheel camber	$-0.5^\circ \pm 0.5^\circ$
		Left-right camber difference	$\leq 0.5^\circ$
		Kingpin inclination angle	$9.7^\circ \pm 1^\circ$
		Kingpin caster angle	$7.1^\circ \pm 1^\circ$
		Maximum steering angle (inner)	41.4°
		Maximum steering angle (outer)	33.7°
	Rear wheel	Single-side rear wheel toe	$9' \pm 6'$
		Rear camber	$-1.4^\circ \pm 0.5^\circ$
		Left-right camber difference	$\leq 0.5^\circ$
	Maximum steering angle (inner)	5.7°	

539

XPENG





Fluids Specifications

Item name	Model	Fill quantity
Front electric drive lubricating oil (L)	FUCHS 4101	1.4
Rear electric drive lubricating oil (L)		1.4
Coolant (L)	Shell universal coolant	2WD: 18.4±2 4WD: 20.2±2
A/C refrigerant (g)	R134a/R1234yf	R134a: 1550±15 R1234yf: 1400±15
Brake fluid (L)	DOT4	Fill to near the MAX line (approx. 1.02±0.05)
Windshield washer fluid (L)	/	3.5



Seat Specifications

In the initial position, the seat adjustment parameters are as follows:

Seat type	Item	Parameter
Driver's Seat	Fore-and-aft adjustment	Total trip 260 mm, 200 mm forward, 60 mm rearward
	Seatback adjustment	Total range 90°, 25° forward, 65° rearward
	Cushion adjustment	Total range 8°, 5° up, 3° down
	Up/down adjustment	Total trip 66.7 mm, 33.3 mm up, 33.4 mm down



Vehicle Information

Front Seat	Fore-and-aft adjustment	Total trip 260 mm, 200 mm forward, 60 mm rearward
	Seatback adjustment	Total range 90°, 25° forward, 65° rearward
	Cushion adjustment	Total range 8°, 5° up, 3° down
	Up/down adjustment	Total trip 66.7 mm, 33.3 mm up, 33.4 mm down
Second row seats(Configuration 1)	Fore-and-aft adjustment	Total trip 510 mm, 320 mm forward, 190 mm rearward
	Seatback adjustment	Total range 101°, 30° forward, 71° rearward
	Cushion adjustment	Total range 15°

Vehicle Information



Second row seats(Configuration 2)	Fore-and-aft adjustment	Total trip 560 mm, 320 mm forward, 240 mm rearward
	Seatback adjustment	Total range 70°, 30° forward, 40° rearward
	Cushion adjustment	Total range 15°
Third row seats	Seatback adjustment	Total range 176°, 98° forward, 78° rearward



Customer Information

Parts and Modifications

Only use genuine XPENG original parts or XPENG-approved parts. XPENG parts have been rigorously tested to ensure their suitability, safety, and reliability. These parts can only be purchased from XPENG service centers and must be installed by XPENG professionals, who can also modify the vehicle according to XPENG experts' recommendations.

Do not modify the vehicle using parts that are not approved XPENG original parts. Doing so may affect vehicle handling, safety, and durability, and may also violate local government regulations.

When modifying the vehicle body (such as installing color-change wraps, transparent protective films, body side moldings, etc.), avoid covering or interfering with the ultrasonic radars, millimeter-wave radars, surround-view cameras, high-perception cameras, and similar areas;

otherwise, the normal operation of assisted driving and related functions may be affected.

The millimeter-wave radars are located inside the front and rear bumpers. Do not repaint, add body kits to, or otherwise modify the front or rear bumpers without authorization, as this may affect the normal operation of assisted driving and related functions.

Do not replace, modify, or add radars or cameras without authorization. Otherwise, the normal operation of assisted driving and related functions may be affected, and radio interference may be generated. XPENG assumes no responsibility for any direct or indirect losses resulting therefrom. If a radar or camera malfunctions, please go to an XPENG service center for repair.

Do not modify the vehicle's suspension, brake, or similar systems, as this may adversely affect vehicle handling and safety.

Do not modify the vehicle's fuse box, as this may adversely affect the vehicle's electrical systems.



Any changes to electronic components, software, or wiring can affect system functions and the proper operation of related components, especially safety-related systems, thereby affecting vehicle operation and increasing the risk of accidents or injury.

Therefore, do not modify the wiring, electronic components, or their software.

In addition, any vehicle damage or performance issues caused by replacement, installation, or modification using parts that are not original XPENG parts or not approved by XPENG are not covered under the warranty. XPENG assumes no responsibility for any direct or indirect losses resulting therefrom.

Event Data Recorder (EDR) System

This vehicle is equipped with an Event Data Recorder (EDR).

The EDR can automatically record information about vehicle operation and the status of vehicle

safety systems for a period of time before and after a vehicle event, such as:

- Vehicle speed.
- Brake pedal status.
- Vehicle VIN.
- Longitudinal acceleration.
- Driver seat belt status.
- Accelerator pedal position, as a percentage of wide-open throttle.
- Power-on cycles at the time of the event.
- Power-on cycles at the time of data retrieval.
- Completeness status of the event data recording.
- Time interval between this event and the previous event.
- Hardware part number of the ECU that records the EDR data.
- Serial number of the ECU that records the EDR data.



- Software part number of the ECU that records the EDR data.
- Lateral acceleration.
- Yaw rate.
- Steering angle.
- Time of the event.
- Gear position.
- Brake pedal position.
- Parking system status.
- Airbag deployment time.
- Seat belt pretensioner activation time.
- Front passenger seat belt status.
- Occupant protection system warning status.
- Tire pressure monitoring system warning status.
- Brake system warning status.
- Cruise control system status.
- Anti-lock braking status.
- Autonomous emergency braking system status.

- Electronic stability control system status.
- Traction control system status.
- Synchronized timestamp prior to the event.

By collecting and analyzing the vehicle status data recorded by the EDR, it is possible to better understand the circumstances before and after the event.

The data recorded by the EDR must be extracted using dedicated diagnostic equipment connected to the vehicle's OBD port. If necessary, contact an XPENG service center to obtain this equipment.

Data Use Statement

XPENG may use the data recorded by the EDR for failure diagnosis, product development, and quality improvement. Except under the circumstances listed below, XPENG will not disclose EDR-recorded data to third parties:

- With the vehicle owner's consent.
- In compliance with requests from administrative or judicial authorities.



- As required by applicable laws and regulations.

Abbreviations

Explanation

Terminology	Explanation	Terminology	Explanation
HUD	HUD	TSR	Traffic Sign Recognition
SR	Surrounding Reality	SAS	Speed Assistance System
AVM	360° Around View Monitor	DSM	Driver Status Monitor
VIN	Vehicle Identification Number (VIN)	EPB	Electronic Parking Brake
LCC	Lane Centering Control	ESC	"Electronic Stability Program"
ALC	Auto Lane Change	ABS	"Antilock Braking System"



Vehicle Information

HNGP	Highway Navigation Guided Pilot	TCS	Traction Control System
XNGP	XPENG Navigation Guided Pilot	EBD	Electronic Brakeforce Distribution
APA	Advanced Parking Assist	EBA	Emergency Brake Assist
FCW	Forward Collision Warning	HHC	Hill Hold Control
AEB	Autonomous Emergency Braking	HDC	Hill Descent Control
BSD	Blind Spot Detection	MCB	Multi-Collision Brake
LCA	Lane Change Alert	IHB	"Intelligent High Beam"
DOW	Door Open Warning	AVAS	Pedestrian Warning

Vehicle Information



RCW	Rear Collision Warning	TPMS	"Tire Pressure Monitoring System"
RAEB	Reverse Automatic Emergency Braking	EDR	Event Data Recorder
RCTA	Rear Cross Traffic Alert	OTA	Over-The-Air
LSS	Lane Support System	OBD	On-Board Diagnostic
LDW	Lane Departure Warning	OMS	Occupant Monitoring System
LKA	Lane Keeping Assistance	V2L	Vehicle-to-Load
ELK	Emergency Lane Keeping	V2V	Vehicle-to-Vehicle



Units of Measurement

Explanation

Terminology	Explanation	Terminology	Explanation
mm	mm	L	liter
m	meter	V	volt
km	kilometer	A	ampere
km/h	kilometers per hour	kW	kilowatt
°C	degrees Celsius	kW·h	kilowatt-hour
°	degree	s	second
'	min	min	min
%	"Percentage"	rpm	revolutions per minute

Vehicle Information



g	gram	N.m	newton-meter
kg	kilogram	kPa	kilopascal
mL	milliliter	bar	bar